

desking

tables, storage and screens

TEMPORARY
PRICE AND SPECIFICATION GUIDE 2022

Contents



Finishes **13**



Fabric Banding **16**



Progress Plus **19**

Electric Sit / Stand Height Adjustable



Progress **31**

Gas Strut Sit / Stand Height Adjustable and Fixed Height



Progress Lite **42**

Manual Sit / Sit Height Adjustable



Linnea Elevate **46**

Fixed Height



Lux **54**

Fixed Height and Benches



Reflex **65**

Fixed Height



Linnea **70**

Fixed Height



Matrix **91**

Height Settable and Fixed Height



Kassini **110**

Manual Sit / Sit Height Adjustable and Fixed Height



Optima Plus **118**

Manual Sit / Sit Height Adjustable and Fixed Height



Callisto **128**

Fixed Height



Windsor **136**

Fixed Height



Flexi **142**

Fixed Height



Modular Meeting Ends **147**



Call Centre **149**



Interact Collaborative Tables **154**



Reception **158**



Conference / Meeting **169**



Modular Tables **196**



Mobile Whiteboard **223**



Pedestals and Personal Storage **225**



Storage **236**



Screens **272**



Park and Hush **302**



Testing Pod **305**



Accessories **307**

	Page		Page
Contact Details	3	Pedestals and Personal Storage	225
Mission Statement	4	Mobile Pedestals	226
Recycling and Environmental Policy	5	Steel Pedestals	228
Standards and Accreditations	6	Desk High Pedestals	229
Production	7	Personal Storage	232
Design Services	8	Handles	234
Ergonomics	9	Storage	236
Dual Board	10	Flare and Combined Storage	237
Acoustic Screens	11	Desk High and Desk Top Storage	239
Park and Echo Acoustic Screens and Panels	12	Planter Units	241
Finishes	13	Desk High and Tall Storage	242
Fabric Bandings	16	Cubeform	248
Progress Plus - Height Adjustable	19	Modular Lockers / HotBox	259
Progress - Fixed and Height Adjustable	31	Recycling Units	267
Progress Lite - Height Adjustable	42	Steel Storage	269
Linnea Elevate - Fixed	46	Screens	272
Lux - Fixed	54	Desk Mounted	272
Reflex - Fixed	65	HPS Desk Mounted	282
Linnea - Fixed	70	Floor Standing	290
Matrix - Height Settable and Fixed	91	HPS Floor Standing	295
Kassini - Height Adjustable and Fixed	110	Huddle Pods - Collaboration System Screens	298
Optima Plus - Height Adjustable and Fixed	118	Park Acoustic Screens - Collaboration System Screens	302
Callisto - Fixed	128	Hush Acoustic Panels - Collaboration System Screens	304
Windsor - Fixed	136	Testing Pods - Pathogen / Covid Testing Pods	305
Flexi - Fixed	142	Accessories	307
Modular Meeting Ends	147	Slat Wall / Screen Mounted Accessories	308
Call Centre	149	Power Modules	314
Interact Collaborative Tables	154	Monitor Arms	322
Reception	158	Lighting	325
Conference / Meeting Tables	169	Various	326
Modular Tables	196	Dimensions	327
Benches	197	Notes	329
Tilt	205	Terms and Conditions	331
Fliptop	207		
Folding	208		
Training	209		
Meeting	210		
Bar	216		
Coffee	217		
Computer / Laptop	222		
Mobile Whiteboard	223		

Contact Details



Head Office, Showroom & Factory.

Elite Road
Goole
East Yorkshire
DN14 8BF

t: +44 (0)1405 746000

email: sales@elite-furniture.co.uk
www.elite-furniture.co.uk



London Office & Showroom

81-87 St John Street
Clerkenwell
London
EC1M 4NQ

t: +44 (0)20 7490 4909

email: londonshowroom@elite-furniture.co.uk



Mission Statement

The Elite story began back in 1986. Building on 34 years of extensive industry experience, Elite has become a pivotal manufacturer of contemporary and adaptive office furniture, workstations and seating solutions.

Influenced by the modern-day workplace, we strive to embrace innovative techniques, using sustainable materials to produce efficient products that complement the office environment.

Although, our business has evolved, our principles have stayed true to our roots and our aim is to provide an efficient and reliable service, one that we're proud to deliver.



Goole Manufacturing, Office and Showroom Facility.

The way we work

The Elite way of doing business means we aim to:

- Exceed clients' expectations.
- Provide the highest quality product, manufactured by a skilled team.
- Listen and learn from experience, to continually grow.
- Develop our people.
- Have integrity when working with partners.

We are aspiring towards a bright future which means the next chapter of our story is going to be an exciting one and one that we want you to be a part of.

History and Highlights

- **1986**
Production started in Howden, East Riding of Yorkshire.
- **1988**
Elite relocates to custom built premises in Goole, East Yorkshire.
- **1996**
Construction begins on a new 64,000 sq. ft. purpose built manufacturing plant.
- **1998**
CAD interior design department introduced, offering 2D & 3D office spacial planning to Elite's dealerships.
Construction began for additional 26,000 sq. ft. extension.
- **2000**
Elite Office Furniture UK Ltd website created.
Construction began for additional 20,000 sq. ft. extension.
- **2002**
Construction began for an additional 50,000 sq. ft factory extension.
Seating production began in-house.
- **2007**
Elite purchased a showroom in the suburb of Islington, London.
Sales and an extended arm of the design planning service is housed there alongside showroom space which is allocated on two floors.
- **2008**
PEFC (Program for the Endorsement of Forest Certification) awarded.
- **2009**
New BLM Adige laser tube cutting machine installed at Goole factory.
New phase 2 corporate website designed and online.
- **2012**
John Hull (M.D.) is awarded I.O.D. (Institute Of Directors) Director Of The Year. Yorkshire & Humber Region.
Elite's screen range designed and manufactured on-site.
- **2013**
John Hull (M.D.) is awarded I.O.D. (Institute Of Directors) Highly Commended Director Of The Year (UK).
- **2015**
New factory planning stage approved.
October: Work commences on new site.
- **2016**
Elite awarded UVDB certification.
- **2017**
John Hull awarded ERYC Chairman's Business Award.
Awarded National UKUPC contract.
- **2018**
Construction of new factory completed.
BS EN ISO 50001 Energy Management.
FORS Bronze Awarded.
- **2019**
Office and production staff relocated to new factory and office.
Grand opening of new manufacturing, showroom and office facility.
- **2020**
Works begun to refurbish London showroom.
Hygiene Protection Screens introduced in response to the Global coronavirus pandemic.
- **2021**
London showroom refurbishment complete.

Recycling Policy

At Elite, we understand the seriousness of the effects waste has on our environment with landfills becoming a substantial problem, but we are committed to refining our recycling efforts. Inappropriate disposal of goods wastes resources, wasting the raw materials and energy used in making the items. Reducing waste by recycling results in less environmental impact, less wasted resources and energy and saves money.

Landfills contaminate and pollute the local environment with the release of harmful greenhouse gases such as methane. The waste buried in landfill sites breaks down at a very slow rate and will remain a significant problem for future generations. Aside from the environmental costs of dumping waste in landfills, there is a rising financial cost too, which is increasing by around 10% a year. Although recycling furniture comes at a cost, it avoids the negative impacts associated with landfills.



REDUNDANT FURNITURE FROM PREMISES



INTRODUCED BACK INTO THE ECONOMY



CHARITY SHOP



SCHOOLS AND COLLEGES

Furniture is typically made up of woods, metals, plastics, fabrics and foams. All of these materials can be recycled with a bit of effort. Our furniture recycling service ensures that furniture is diverted from landfill, whether this is through materials recycling or ethical reuse routes. Any furniture which is suitable for reuse will be donated to charities, schools and social enterprises. We have access to 120,000 square foot of storage space specifically for the task of recycling as a growing method of disposal.

By recycling redundant office furniture, we are preventing it from becoming an environmental problem. Our duty to care for our environment is increasing and as a company we will continue our efforts in responsibly managing waste.

Environmental Policy

Elite are committed to considering environmental factors during all production activities and future plans

This includes the consideration of:

- Global Warming
- Acid Rain
- Deforestation
- Loss of Biodiversity
- Solvent Reduction
- Minimising Pollution
- Waste Minimisation
- Energy Efficiency
- Green Purchasing
- Recycling Schemes
- Fleet Transmission Emissions
- Material Consumption
- Zero Land Contamination
- Wastewater Drainage
- Ensuring Zero Land Contamination
- Drainage Protection

It is our policy to:

- Comply with and aim to exceed the requirements of current environmental legislation and codes of practice.
- Minimise energy and water usage in our buildings and processes in order to conserve supplies, and minimise our consumption of natural resources, especially where they are non-renewable.
- Minimise our waste and reuse or recycle as much of it as possible.
- Purchase products and services that do the least damage to the environment and encourage others to do the same.
- Assess the environmental impact of any new processes or products we intend to introduce.
- Monitor and reduce the impact of air, water, noise and light pollution from our premises on the environment and local community.
- Ensure all employees understand our environmental policy and conform to the high standards it requires.
- Address complaints about any breach of our Environmental Policy promptly and to the satisfaction of all concerned.
- Review our Environmental Policy annually, in consultation with employees and customers.

Standards and Accreditations

Company Accreditations



Furniture Accreditations

BS EN 527-1:2011
Office furniture desk dimensions.

BS EN 527-2:2002
Office furniture desk mechanical safety requirements.

BS EN 527-3:2003
Office furniture desk strength and stability.

BS EN ISO 9241-5:1999
Ergonomics of VDU/TFT screen usage within offices.

BS 4875-7:2006
Strength and stability of shelving.
Test level 4 (shelves only).

BS 6396:2008 + A1:2015
Office furniture desk electrical systems.

BS EN 13722:2004
Gloss/reflective level testing on furniture surfaces.

BS EN 14073-2:2004
Strength and rigidity testing of storage furniture part 2.

BS EN 14073-3:2004
Strength and rigidity testing of storage furniture part 3.

BS EN 14074:2004
Endurance and stability testing of storage furniture.

BS EN 15372:2008 level 2
Standard and folding tables structurally suitable and stable for general contract use.

BS EN 14323:2004
Dual Board resistance to scratching, cracking and staining.

Dividing Screen Accreditations

BS 476-7:1987
Flammability test for Screens (Class 2).

BS EN 1023-1:1997
Office furniture screens, dimensions.

BS EN 1023-2:2000
Office furniture screens, mechanical safety requirements.

BS EN 1023-3:2000
Office furniture screens, test methods.

Acoustic Screen Accreditations

BS EN ISO 354:2003
Measurement of sound absorption in a reverberation room.

ISO 11654:1997
Sound absorbers for use in buildings - Rating of sound absorption.

ISO 9613 -2:1996
Attenuation of sound during propagation outdoors.

ISO 9613-1:1993
Calculation of the absorption of sound by the atmosphere.

BS EN 12667:2001
Thermal Conductivity / Resistance Performance.

BS EN 13501-1:2007 +A1:2009
Fire Classification Of Construction Products Building Elements.

BS EN 13823:2010 + A1:2014
Reaction to Fire Tests. Thermal attack by single burning item.

BS EN ISO 11925-2:2010
Reaction to Fire Tests. Ignitability of building products subjected to direct impregnation of flame - part 2 Single-flame source test.

Seating Accreditations

BS EN 1022:2005
Seating, determination of stability.

BS EN 1335-1 + BS EN 1335-2 + BS EN 1335-3
Office work chairs safety test methods.

BS EN 1728:2012 + AC:2013
Seat and Back Static Load Test and Durability.
Front and Back Fatigue Test and Impact Test.

BS EN 5459-2: 2000+A2:2008
Office seating for use by person weighing up to 150kg and for use up-to 24 hours a day.

BS EN 13761:2002
Visitor Chairs - Dimensions and Safety Requirements.

BS EN 15373:2007 level 2
Seating strength, durability and safety.
Requirements for non-domestic seating.

BS EN 16139:2013
4 Legged and cantilever seating, strength, durability and safety requirements.

BS EN 10025:1993
Specification for hot rolled products of non-alloy structural steels and their technical delivery conditions.
Applicable to all chrome plated parts.

ANSI/BIFMA X5.1-2011
International testing certificate for office chairs.
Sections:05,11.3,13,14 and 15.

TUV Eco-Circle 2008
Tested for recyclable content, harmful substances, energy saving and ergonomic design.

NEOCON
Silver Award Winner 2013 Chicago, USA.



Proudly Manufactured
In **Great Britain**



Design Services



At the heart of Elite lies our design and marketing department that over twenty years has grown from one to seven members. The workplace is continuously evolving, with new concepts and studies shaping the way we design the environment. Our most effective way of maintaining focus on current workplace trends is through attendance at trade shows and exhibitions where we have the opportunity to meet designers and industry influencers who are selected as key-speakers, often covering pressing industry topics.

The design team delivers a breadth of varied services from 2D spacial planning to realistic 3D computer generated visuals. Whether space permits large volumes of staffing or space is an issue, the team will offer successful and practical solutions that take advantage of the available space.

Each project is carefully analysed to achieve the very best layout and conformability to your requirements, complying to current health and safety laws and guidelines. 3D design is now a well-established practice in office design and provides the best method of illustrating office layout designs. We are working to industry standard BIM level 2, that involves developing building information in a collaborative 3D environment with data attached.

For your convenience, all available CAD and Revit Blocks, Product Thumbnails and Assembly Instructions are available at <https://www.elite-furniture.co.uk/project/downloads/>



Ergonomics

Ergonomics is an applied science that aims to understand people physically and psychologically, in order to design and arrange products, environments and processes for human interaction in the most safe and efficient ways.

Sitting with the correct posture is crucial for maintaining good health, allowing bones and joints to align, decreasing the abnormal wearing of joints that could cause joint pain or even degenerative arthritis. It also reduces stress on the ligaments holding spinal joints together, minimizing the likelihood of injury. There are increasing reports of musculoskeletal disorders caused by poor workstation set ups, poor posture, repetitive movements, intensive work and infrequent breaks.

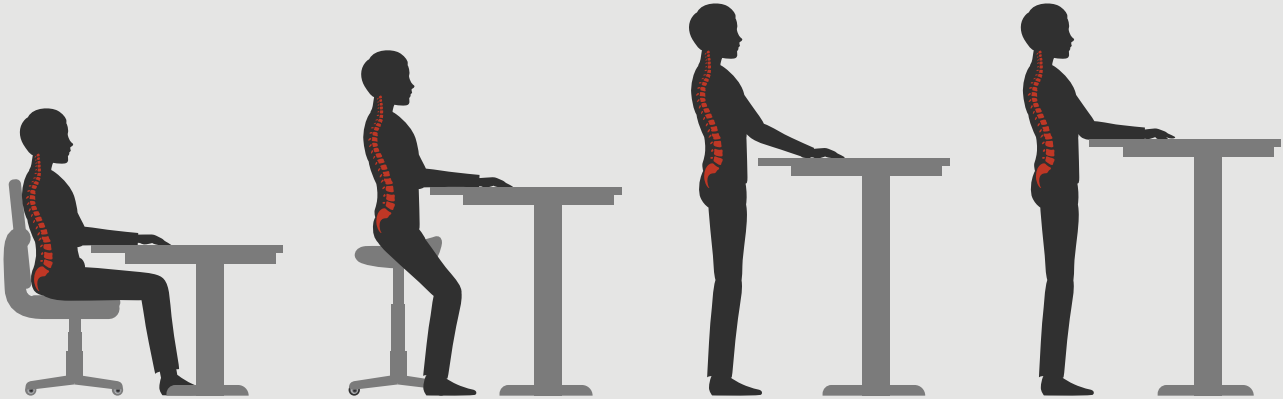

A good posture allows muscles to work more efficiently, allowing the body to use less energy and therefore, preventing muscle fatigue. It helps prevent muscle strain, overuse disorders and even back and muscular pain. Taking care of your posture will maximise comfort, safety and performance, allowing you to focus on what's important.

Chairs that have given consideration for ergonomics have a multitude of advantages. As well as correctly supporting the users posture, they provide supreme comfort with headrests, preventing neck problems and the inclusion of a cushioned seat pad as opposed to a hard seat reduces the pressure on the hips.

The diagram below illustrates the recommended natural posture, demonstrating less stress on the body, reducing the chances of harm and injury to the individual. The ergonomic chair ensures appropriate alignment of the body including the eyes, head, neck, shoulders, arms, back, knees and feet all in relation to the desk and computer screen.

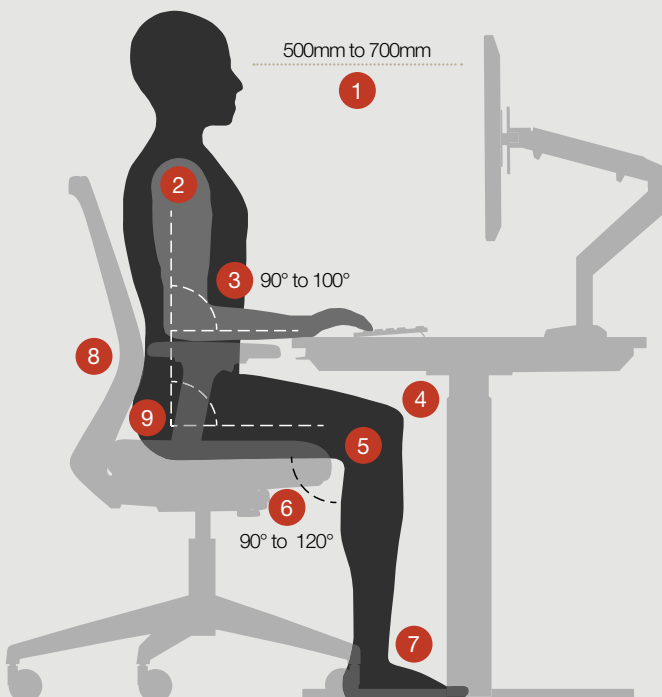

Posture guidelines

- 1 Maintain a distance between eyes and screen of 500mm to 700mm.
- 2 Keep your shoulders relaxed and not raised.
- 3 Keep your forearms horizontal and elbows bent at an angle slightly in excess of 90°.
- 4 Maintain a distance between knees and desk of 80 to 100mm.
- 5 Avoid pressure to the area behind the knees.
- 6 Keep your legs bent at an angle of between 90° to 120°.
- 7 Keep your feet resting on the floor.
- 8 Let the backrest support your back.
- 9 Sit firmly against the back with a small gap between the front of the seat pad and the back of your knees.

Dual Board Superior Melamine Board (MFC)



We are a proud
PEFC member

Programme For The Endorsement Of Forest Certification (PEFC)

PEFC is the world's largest forest certification organisation.

PEFC are dedicated to promoting Sustainable Forest Management through independent third-party certification.

PEFC expands forest certification globally through its unique bottom-up approach to certification and is the certification system of choice for family and community-owned forests.

PEFC are an international non-profit, non-governmental organisation devoted to ensuring that forests are managed according to environmental, social and economic criteria.

Elite are an exclusive user of the superior quality melamine board called 'Dual Board'. The board consists of a chipboard core surfaced on both sides by a sheet of MDF. The newly developed 'Dual Board' material offers significant advantages including structural, machining and component strength. The material offers Elite's client increased quality and added value. It offers greater impact resistance combining the durability of MDF and Chipboard into a single board.

The MDF faces of 'Dual Board' eliminates any irregularities associated with raw chipboard and translates this into a smooth, even surface. For our highly complex production operation this level of board performance is essential and translates directly into the high standards of quality offered to Elite clients.



Perfect cutting during manufacture.



Thanks to its high physical-mechanical performance, Dual Board provides an excellent response in the most demanding load situations.



High resistance to impact.
This prevents marks, deformities or surface damage.



The properties of the exterior high-density fibre layer reduce surface absorption.



BS EN 13722:2004
Gloss/reflective level testing on furniture surfaces.

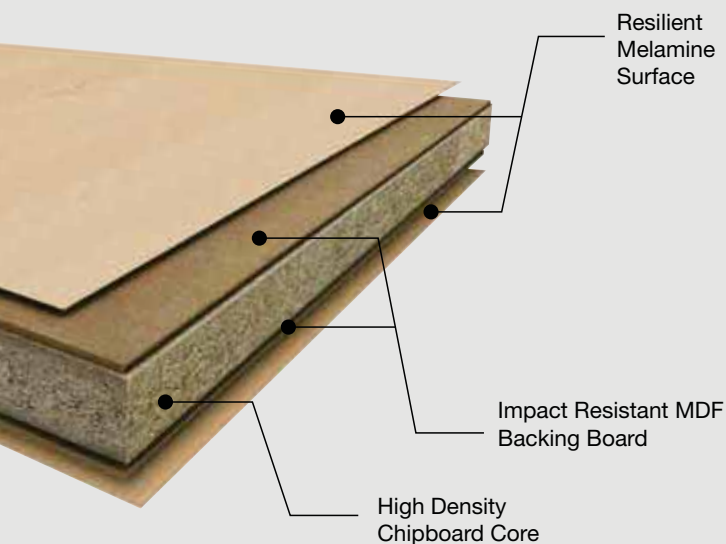

Acoustic Screens

Class B Acoustic Screens

Flexible working environments are continuing to become essential in the workplace, with a requirement to accommodate a broad range of users. Removing walls as active barriers and opting for open plan offices and furniture layouts, utilises the building footprint and delivers modular furniture to support agile working techniques. With the higher number of employees using the same space, the noise within a closer proximity increases.

Research suggests that one of the biggest contributing factors of workplace unrest is inadequate acoustics and consideration must be given to employees working in congested environments to support their productivity. Investing in acoustic screen solutions will increase efficiency and employee morale, demonstrating a considerate approach to individual's wellbeing.

Acoustic Screen Accreditations

ISO 354:2003
Measurement of sound absorption in a reverberation room.

ISO 11654:1997
Sound absorbers for use in buildings - Rating of sound absorption.

ISO 9613-1:1993
Attenuation of sound during propagation outdoors.
Calculation of the absorption of sound by the atmosphere.

EN 12667:2001
Thermal Conductivity / Resistance Performance.

EN 13501-1:2007 +A1:2009
Fire Classification Of Construction Products Building Elements.

EN 13823:2010
Reaction to Fire Tests. Thermal attack by single burning item.

ISO 11925-2:2010
Reaction to Fire Tests. Ignitability of building products subjected to direct impregnation of flame - part 2 Single-flame source test.

Product Attributes

Acoustic Certification
Achieved class B - 0.85(H)

Sound Absorption
GB/T20247-2006/ISO354:2003 A Level.

Environmental
GB/T5849-2006 E0 Level.

Fire Retardant
GB 862402006 B Level.
EN 13501-1:2007+A1:2009 B Level.

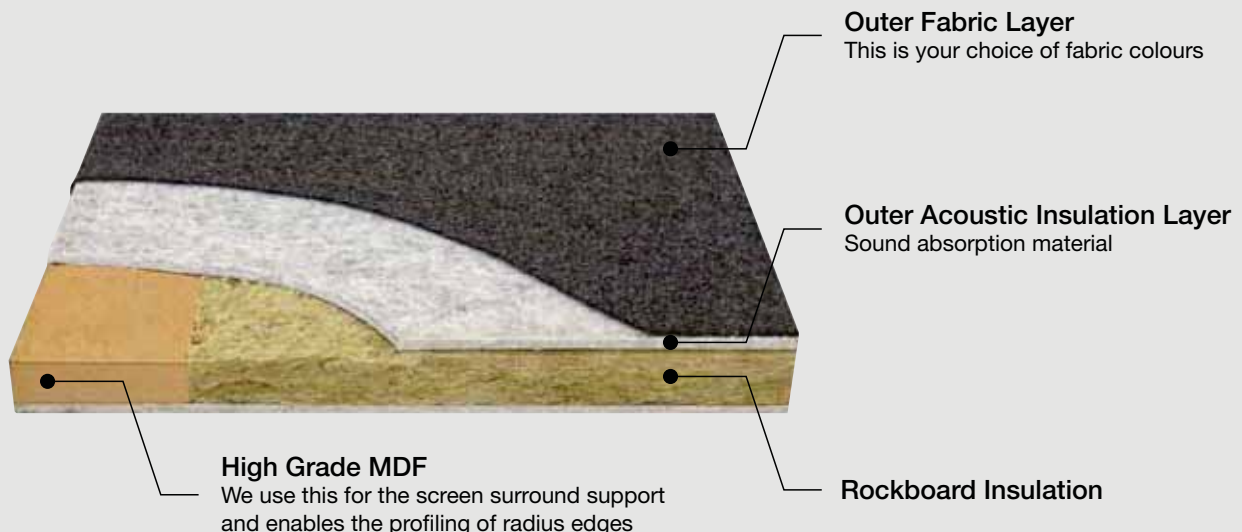

Acoustic Screens and Panels

Park

Park acoustic panels have been inspired by the shapes and colours of nature. All timber is fully certified to FSC standards emphasising the strict eco and sustainability philosophy that lead to the creation of **Park** screens mirroring the traditional tree shape.

When screens are grouped together the shape of a forest can be created and made even more realistic by the fact that the fabric options available mirror the colours of the leaves in spring, summer and autumn.

Clustering screens creates a partition wall to divide and define the workplace. The lightweight construction enables **Park** to be configured and re-configured easily creating lounge, meeting room and private spaces within the open plan environment.

Park offers a highly practical dividing screen function with optimal sound absorption compliant with UNI ISO 354 and UNI EN ISO 11654 standards.



Park and Hush

Elegant and beautifully finished with warm oak details, they are available in a variety of different coloured fabrics. The panels in the new **Hush** and **Park** ranges add a touch of class as well as effectively reducing reverberation, particularly in large rooms.

The need to reduce echoes generated by speech and other sounds has become increasingly important in recent years. Interior designers have gained a greater understanding of how acoustic comfort is a key factor in helping to improve one's quality of life. It helps you concentrate when you are working or studying and in places where people meet and socialise, it reduces reverberations and enables you to understand what other people are saying more easily.

In any case, the clarity of sound conveys a sense of well-being and relaxation, while it is now accepted that spending a long time in an environment where the acoustics are poor causes high levels of stress and psychological discomfort.

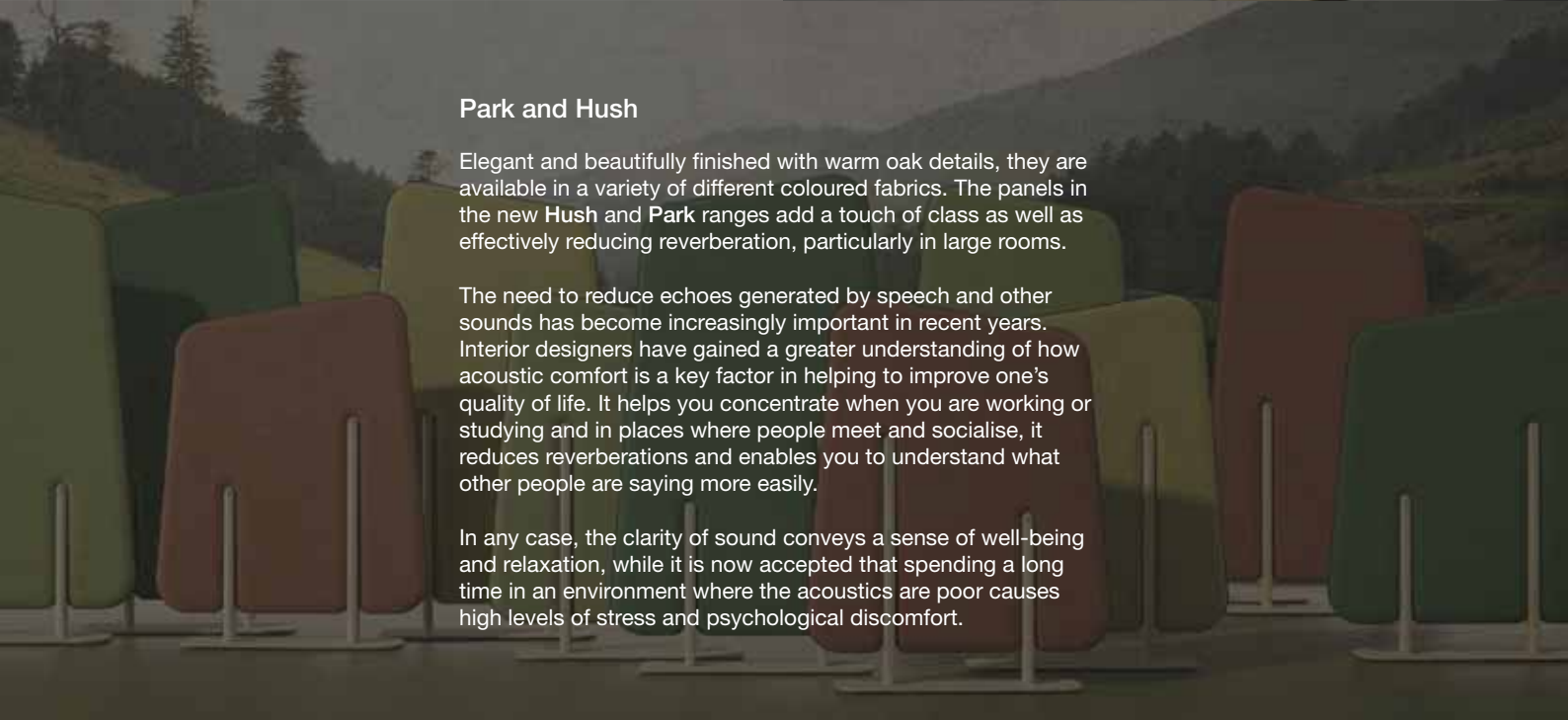

Hush

Hush acoustic panels can be arranged in a variety of configurations dependent on your requirements. They can be mounted to walls and ceilings ensuring sufficient absorption within the chosen environment. The panels are simple to install, dismantle and reassemble for complete flexibility.

Hush panels are high performance soundproofing specifically developed to offer complete flexibility. Each panel is upholstered in a two tone fabric enabling panels to be reversed refreshing the environment aesthetics. There are 5 colour combinations within the range.

Hush panels comply with UNI EN ISO 354 and UNI EN ISO 11654 standards.



Finishes

Standard Dual Board MFC Finishes

- The 10 finishes below are our standard 25mm and 18mm MFC finishes.



Ash



Autumn Cherry



Beech



Chester Oak



English Walnut

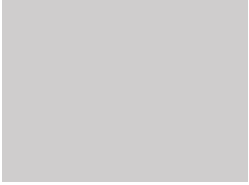

Grey



Grey Nebraska Oak



Laurentii Wenge



Natural Nebraska Oak

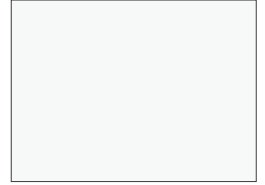

White

Standard Contrasting Edging Options for White Dual Board MFC and Nanotech Finishes

- The 3 finishes below are standard edging options for 25mm white Dual Board MFC and Nanotech finishes only.
- Add £32 retail per top for Black or Laurentii Wenge edging and add £42 retail per top for Plywood edging.



Black with White
+£32 per top



Laurentii Wenge with White
+£32 per top



Plywood Effect with White
+£42 per top

Standard Veneer Finishes

- The 2 finishes below are our standard 25mm and 18mm Veneer finishes.
- Elite cannot guarantee continuity in the appearance of veneer panels.
- Elite process pre-veneered boards that cannot be book or colour matched.



Oak



Walnut

Nanotech Finish

- The finish below is our Nanotech finish and is subject to a two week lead time.
- Undercut edging detail option available.
- Contact Customer Services for specification, prices and lead time.

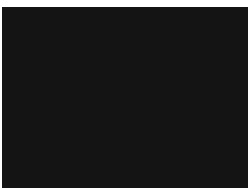

Black Matt MDF

Finishes

Alto, Harmony and Loco Solid Wood Finishes

- The finish below is a non-standard 32mm Solid Wood finish that can be specified on Alto, Harmony and Loco Benches only.
- Finish supplied with square edging only.
- This material is natural and it's appearance will vary including grain patterns and burring / knots in the surface.
- Subject to a 3 week lead time, see individual product pages for specification and pricing.



Oak

Coloured MFC Finishes

- The 6 finishes below are non-standard 18mm MFC finishes that can be specified on select items only.
- Matching edging tape.
- Subject to a 3 week lead time, see individual product pages for further specification and pricing.

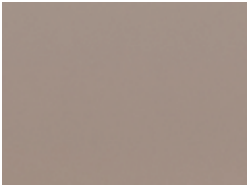

Paraline



Petrol



Red



Sea Blue



Turquoise



Yellow

Wooden Frame Finishes

- The 7 finishes below are available on ranges where wooden frames are specified, see individual product pages for specification and pricing.
- Due to the staining process and the use of natural materials, no guarantee can be given to the final appearance and continuity when staining timber products.
- See individual product pages for specification and pricing.



Ash



Beech



Stained Walnut



Stained Espresso



Stained Wenge



Stained Black



White

Finishes

Standard Metalwork Finishes

- The 3 finishes below are our standard Metalwork finishes.



Elite Silver RAL 9006



Black Graphite RAL 9004



White RAL 9003

Item Specific Metalwork Finishes

- The 8 finishes below are non-standard Metalwork finishes which can be specified where indicated.
- Add specified price or add 15% to retail price for Chrome Effect finish and 5% to retail price for Raw Metalwork finish.
- Add specified price or 12% to retail price for Blue, Coral, Green, Light Grey, Teal and Yellow finishes and is subject to a two week lead time.
- See individual product pages for further specification and pricing.



Chrome Effect
+15%



Raw
+5%



Blue RAL 5001
+12%



Coral RAL 2001
+12%



Green RAL 6016
+12%



Light Grey RAL 7038
+12%



Teal RAL 5018
+12%



Yellow RAL 1021
+12%

Acrylic Finishes

- The 6 finishes below are available on our Acrylic Screens.
- All Hygiene Protection Screens are available in Clear Acrylic only.

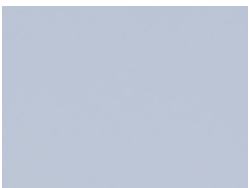

Blue



Green



Orange



Red

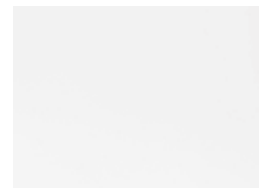



Frosted



Clear











Fabric Bandings

Lead time subject to fabric availability, please contact customer services for clarification

















































Recommended fabrics for our soft seating ranges  

Surcharge Applicable 

Group 1

Supplier	Range	Supplier	Range
Agua	Task 	Inloom	Alba
Camira	Advantage  	Inloom	Bondai
Camira	Canopy	Inloom	Erika
Camira	Citadel	Panaz	Highland   
Camira	Era  	Panaz	Marna 
Camira	Gravity	Camira	Cara (Screen / Panel Fabric)
Camira	Manhattan	Camira	Carlow (Screen / Panel Fabric)
Camira	Phoenix	Camira	Era 170 (Screen / Panel Fabric)
Camira	Rivet	Camira	Lucia (Screen / Panel Fabric)
Camira	Target	Camira	Racer (Screen / Panel Fabric)
Camira	Xtreme	Camira	Sonus (Screen / Panel Fabric)
Gabriel	Fighter 		

Group 2

Supplier	Range	Supplier	Range
Agua	Libra   	Gabriel	Repetto   
Agua	Linetta 	Gabriel	Step   
Camira	Aspect  	Gabriel	Step Melange   
Camira	Chateau	Inloom	King Flex
Camira	Main Line Plus  	Inloom	One
Camira	Patina	Panaz	Alba 
Camira	Sprint	Panaz	Eve 
Camira	Urban	Panaz	Harvard   
Camira	X2	Panaz	Highland Stretch with Matte Finish   
Gabriel	Atlantic 	Panaz	Microvelle 
Gabriel	Chilli   	Panaz	Montagu   
Gabriel	Go Check   	Camira	Lucia CS Screen (Screen / Panel Fabric)
Gabriel	Go Couture   	Camira	Sonus Etch (Screen / Panel Fabric)
Gabriel	Go Uni   	Gabriel	Event Screen + (Screen / Panel Fabric)
Gabriel	Medley   	Gabriel	Thrill (Screen / Panel Fabric) 
Gabriel	Noma 	Gabriel	Twist (Screen / Panel Fabric) 

* Please note, when ordering less than 10 units in any Agua, Bute, Chieftain, Crest, Spradling, Panaz or Yarwood fabric the order will be subject to a £15.00 surcharge.



* Please note, when ordering less than 20 units in any Gabriel fabric the order will be subject to a £43.00 surcharge.

* Please note, when ordering less than 15 units in any Kvadrat or Vescom fabric the order will be subject to a £36.00 surcharge.

When multiple fabric band selections are specified, the unit price will reflect the highest band fabric requested.

























































Fabric Bandings

Lead time subject to fabric availability, please contact customer services for clarification

































































Recommended fabrics for our soft seating ranges  

Surcharge Applicable 

Group 3

Supplier	Range	Supplier	Range
Agua	Carmina 	Gabriel	Tonal 
Agua	Cashmir   	Inloom	Jeans  
Agua	Nova   	Inloom	Jet
Agua	Sark   	Inloom	Jet Bioactive
Agua	Tones   	Inloom	Riva
Camira	Halcyon Collection (Cedar)  	Inloom	Roccia  
Camira	Honeycomb  	Panaz	Altair   
Camira	Main Line Flax  	Panaz	Kilda 
Camira	Nexus	Panaz	Linear   
Camira	Oceanic  	Panaz	Lush   
Camira	Sumi  	Panaz	Luxe Performance Velvet   
Gabriel	Connect   	Svensson	Easy
Gabriel	Felicity 	Svensson	Semi  
Gabriel	Flex 	Svensson	Tone
Gabriel	Just 	Camira	Blazer Lite (Screen / Panel Fabric)
Gabriel	Mica 	Camira	Nexus (Screen / Panel Fabric)
Gabriel	Rondo   	Gabriel	Twist Melange (Screen / Panel Fabric) 
Gabriel	Tempt   		

Group 4

Supplier	Range	Supplier	Range
Camira	24/7 +	Gabriel	Capture   
Camira	24/7 Flax  	Gabriel	Crisp   
Camira	Aquarius  	Gabriel	Europost 2   
Camira	Blazer  	Gabriel	Fame   
Camira	Halcyon Collection (Aspen, Blossom)  	Gabriel	Gaja Classic   
Camira	Hemp  	Gabriel	Harlequin 
Camira	Hi-Tech	Gabriel	Select   
Camira	Intervene Plain and Texture  	Inloom	Bondai Linea (Quilted)
Camira	Kyoto  	Inloom	Milano  
Camira	Landscape (Balance and Contract)  	Panaz	Allure   
Camira	Mainline Flax Stripe  	Panaz	Lara   
Camira	Regent Velvet **MOQ 10m**	Svensson	Hello
Camira	Silk  	Camira	Synergy 170 (Screen / Panel Fabric)
Camira	Synergy  	Gabriel	Atlantic Screen 170 (Screen / Panel Fabric) 
Camira	Track  	Gabriel	Just 170 (Screen / Panel Fabric) 
Chieftain	Carousel   	Gabriel	Mica 170 (Screen / Panel Fabric) 
Chieftain	Ravel   	Gabriel	Tonal 170 (Screen / Panel Fabric) 
Gabriel	Bond   		

* Please note, when ordering less than 10 units in any Agua, Bute, Chieftain, Crest, Spradling, Panaz or Yarwood fabric the order will be subject to a £15.00 surcharge.



* Please note, when ordering less than 20 units in any Gabriel fabric the order will be subject to a £43.00 surcharge.

* Please note, when ordering less than 15 units in any Kvadrat or Vescom fabric the order will be subject to a £36.00 surcharge.

When multiple fabric band selections are specified, the unit price will reflect the highest band fabric requested.





















Fabric Bandings















Lead time subject to fabric availability, please contact customer services for clarification

Recommended fabrics for our soft seating ranges  





















Surcharge Applicable 









Group 5

Supplier	Range
Camira	Individuo  
Camira	Yoredale  
Camira	Zap  
Gabriel	Breeze Fusion   
Gabriel	CrissCross   
Gabriel	Fame Hybrid   
Gabriel	Gaja C2C 
Gabriel	Harmony 
Gabriel	Mood   









































Supplier	Range
Gabriel	Passion   
Inloom	Corte  
Inloom	Spazio
Svensson	Harper  
Svensson	Khaki  
Svensson	Urban  
Vescom	Cres 
Vescom	Samar   

























Group 6

Supplier	Range
Bute	Elgin 
Bute	Magic   
Bute	Mercury   
Camira	Armadillo  
Camira	Craggan Flax  
Gabriel	Luna 2   
Gabriel	Morph   
Svensson	Accessoire  
Svensson	Heritage  
Svensson	Mingel

Supplier	Range
Svensson	Revolt  
Svensson	Rock  
Svensson	Softmill
Svensson	Step
Svensson	Tableau  
Svensson	Velvet
Svensson	VY
Vescom	Acton 
Vescom	Lombok 

Group 7

Supplier	Range
Bute	Identity: Kin and Clan   
Bute	Strata: Mason and Mineral   
Camira	Corrosion  
Camira	Nettle Aztec  
Camira	Synergy Quilt (Channel, Chevron, Hourglass)
Gabriel	Atlantic Square, Stripe 25, Stripe 40 Quilted Ranges 
Gabriel	Comfort +   
Kvadrat	Clara 2   
Kvadrat	Field 2   
Kvadrat	Floyd   
Kvadrat	Hero   
Kvadrat	Reflect   
Kvadrat	Relate 
Kvadrat	Remix 3   
Kvadrat	Steelcut Trio 3   
Svensson	Balance  
Svensson	Be On  

Supplier	Range
Svensson	Brink
Svensson	Club  
Svensson	Debut  
Svensson	Ink  
Svensson	Kent
Svensson	Moss  
Svensson	Poppy  
Vescom	Bowen 
Vescom	Burton 
Vescom	Eliot   
Vescom	Lindau   
Gabriel	Hush Square (Screen / Panel Fabric) 
Gabriel	Hush Stripe 25 (Screen / Panel Fabric) 
Gabriel	Hush Stripe 40 (Screen / Panel Fabric) 
Kvadrat	Floyd Screen 170 (Screen / Panel Fabric) 
Kvadrat	Hint 170 (Screen / Panel Fabric) 
Kvadrat	Relate Screen 170 (Screen / Panel Fabric) 

Leather

Supplier	Range
Crest	Shelly   
Yarwood	Style   

* Please note, when ordering less than 10 units in any Agua, Bute, Chieftain, Crest, Spradling, Panaz or Yarwood fabric the order will be subject to a £15.00 surcharge.

* Please note, when ordering less than 20 units in any Gabriel fabric the order will be subject to a £43.00 surcharge.

* Please note, when ordering less than 15 units in any Kvadrat or Vescom fabric the order will be subject to a £36.00 surcharge.

When multiple fabric band selections are specified, the unit price will reflect the highest band fabric requested.

Progress Plus Electric Sit / Stand Height Adjustable Workstations



With its clean lines and lightweight design, Progress Plus has been designed to blend into the modern office environment. Its electric height adjustment enables a smooth transition between sitting and standing, allowing users to vary their posture throughout the day. Progress Plus features an optional control panel that is operated using Bluetooth® technology between the desk and an advanced mobile app, aimed at developing a healthy routine into the workday. The panel tracks the usage of the desk, reminding users to adjust their station, changing the users prolonged sitting behaviour. Within the frame, there is an innovative wire management tray that conceals cables and is easily accessed using two folding hoods. To further personalise the desk, there are a number of optional accessories to complement the range.

Lead Time: 3 Weeks

Wood: Available in MFC (Ash, Autumn Cherry, Beech, Chester Oak, English Walnut, Grey, Grey Nebraska Oak, Laurentii Wenge, Natural Nebraska Oak and White)
Top Panel Edge Detail available on 25mm White MFC (Wenge and Black - Add £32 Retail Per Top) (Plywood - Add £42 Retail Per Top)
Available in Veneer (Oak and Walnut)

Metalwork: Available in Silver RAL 9006 (Standard), Black Graphite RAL 9004 and White RAL 9003



PP16/16/EHA

Progress Plus Electric Height Adjustable Double Bench

- 3 week lead time. • 25mm sliding top panel.
- Sit / stand height adjustment of 650mm-1280mm via electronic up / down keypad.
- Complete with 2x horizontal cable trays. • Anti-collision as standard.
- 640h mobile pedestals will clash with standard double benches, as an alternative, upgrade to Progress Plus advanced keypad (see page 21).
- 640h mobile pedestals will protrude with 1200d double benches, as an alternative, use MPF and MP3 pedestals (see page 226).

	MFC	Veneer
PP18/16/EHA - 1800w x 1600d x 650-1280h	£2,865	£3,546
PP16/16/EHA - 1600w x 1600d x 650-1280h	£2,809	£3,423
PP14/16/EHA - 1400w x 1600d x 650-1280h	£2,752	£3,366
PP12/16/EHA - 1200w x 1600d x 650-1280h	£2,696	£3,310
PP18/12/EHA - 1800w x 1200d x 650-1280h	£2,632	£3,195
PP16/12/EHA - 1600w x 1200d x 650-1280h	£2,580	£3,143
PP14/12/EHA - 1400w x 1200d x 650-1280h	£2,528	£3,091
PP12/12/EHA - 1200w x 1200d x 650-1280h	£2,476	£3,039



PPR16/8/EHA

Progress Plus Electric Height Adjustable Rectangular Desk

- 3 week lead time. • 25mm top panel.
- Sit / stand height adjustment of 650mm-1280mm via electronic up / down keypad.
- Complete with a horizontal cable tray. • Anti-collision as standard.
- 640h mobile pedestals will clash with standard rectangular, as an alternative, upgrade to Progress Plus advanced keypad (see page 21).

	MFC	Veneer
PPR18/8/EHA - 1800w x 800d x 650-1280h	£1,418	£1,724
PPR16/8/EHA - 1600w x 800d x 650-1280h	£1,390	£1,696
PPR14/8/EHA - 1400w x 800d x 650-1280h	£1,362	£1,667
PPR12/8/EHA - 1200w x 800d x 650-1280h	£1,333	£1,640
PPR18/6/EHA - 1800w x 600d x 650-1280h	£1,305	£1,586
PPR16/6/EHA - 1600w x 600d x 650-1280h	£1,277	£1,558
PPR14/6/EHA - 1400w x 600d x 650-1280h	£1,252	£1,533
PPR12/6/EHA - 1200w x 600d x 650-1280h	£1,224	£1,505



PP120/12/8

Progress Plus Electric Height Adjustable 120 Degree Workstation

- 3 week lead time. • 25mm top panel.
- Sit / stand height adjustment of 650mm-1280mm via electronic up / down keypad.
- Complete with a horizontal cable tray. • Anti-collision as standard.
- 640h mobile pedestals will clash with standard 120 degree workstations, as an alternative, upgrade to Progress Plus advanced keypad (see page 21).

	MFC	Veneer
PP120/12/8/EHA - 2956w (dia) x 1200-800d x 650-1280h	£6,019	£7,080
PP120/12/6/EHA - 2956w (dia) x 1200-600d x 650-1280h	£5,713	£6,730
PP120/10/6/EHA - 2360w (dia) x 1000-600d x 650-1280h	£5,409	£6,374

Progress Plus Accessories

Lead Time: Standard (All products are manufactured to order and when 'Standard Lead Time' is quoted (7 – 10 days), this may vary dependant on volume ordered, factory capacity and distribution requirements at the time of ordering. For more information please contact your Dealer Business Manager or the Customer Services Team for clarification.)

Wood: Available in MFC (Ash, Autumn Cherry, Beech, Chester Oak, English Walnut, Grey, Grey Nebraska Oak, Laurentii Wenge, Natural Nebraska Oak and White)
Available in Veneer (Oak and Walnut) on a 3 Week Lead Time

Metalwork: Available in Silver RAL 9006 (Standard), Black Graphite RAL 9004 and White RAL 9003



/PPKP

Progress Plus Advanced Keypad

- Upgrade Progress Plus standard keypad or retrofit.
- Extra features include setting upper and lower height restrictions, memory function and anti-collision sensitivity.
- To upgrade, suffix code to end of chosen desk (e.g. PPR16/8/EHA/PPKP).

	Price
.../PPKP3 - 120 Degree Workstation Upgrade at Point of Purchase	£123
.../PPKP2 - Double Bench Upgrade at Point of Purchase	£82
.../PPKP - Single Workstation Upgrade at Point of Purchase	£41
PPKP3 - 120 Degree Workstation Retrofit after Purchase	£147
PPKP2 - Double Bench Retrofit after Purchase	£98
PPKP - Single Workstation Retrofit after Purchase	£49



PPKPD

Progress Plus Advanced Keypad App Dongle

- Progress Plus advanced keypad required for this product.
- For use with a mobile application, refer to Progress Plus user guide.
- Provides access to a healthy working programme.

	Price
PPKPD	£57



PPLM

Progress Plus Locking Mechanism

- Sold in pairs.
- Retrofittable locking mechanism.
- Located under bench top.

	Price
PPLM - Sold in Pairs	£58



PPDDSE

Progress Plus Decorative Slab End

- For use on one end of the workstation (for use on both ends, specify 2x slab ends).

	MFC	Veneer (3 Week Lead Time)
PPDDSE - For 1600d Ends - 1500w x 25d x 540h	£191	£306
PPSDSE - For 800d Ends - 760w x 25d x 540h	£127	£205



PPRMP16
Illustrated in red

Progress Plus Steel Modesty Panel

- Modesty panels are 300mm high.

	Metalwork
PPRMP18 - For 1800w Workstations - 1500w	£172
PPRMP16 - For 1600w Workstations - 1300w	£170
PPRMP14 - For 1400w Workstations - 1100w	£165
PPRMP12 - For 1200w Workstations - 900w	£161

Progress Plus Accessories

Lead Time: Standard (All products are manufactured to order and when 'Standard Lead Time' is quoted (7 – 10 days), this may vary dependant on volume ordered, factory capacity and distribution requirements at the time of ordering. For more information please contact your Dealer Business Manager or the Customer Services Team for clarification.)

Metalwork: Available in Silver RAL 9006 (Standard), Black Graphite RAL 9004 and White RAL 9003



PPRCT16
Illustrated in red

Progress Plus Double Bench Cable Tray

- Compatible with Progress Plus double benches only.
- Cable tray positioned underneath fixed horizontal cable trays.
- Cable tray can be closed to cover exposed cables.
- Double bench cable trays are 230mm deep and 78mm high.

Metalwork

PPRCT18	- For 1800w Workstations	- 1560w	_____	£194
PPRCT16	- For 1600w Workstations	- 1360w	_____	£179
PPRCT14	- For 1400w Workstations	- 1160w	_____	£165
PPRCT12	- For 1200w Workstations	- 960w	_____	£152



PPLCT
Illustrated in red

Progress Plus Double Bench Linking Cable Tray

- Compatible with Progress Plus double benches with double bench cable tray only.
- Allows cables to pass safely between 2 double benches.
- Double bench cable trays are 135mm deep and 35mm high.

Metalwork

PPLCT	- For All Workstations	- 260w	_____	£152
--------------	------------------------	--------	-------	------



PPFP
Illustrated in red

Progress Plus Linking Plate

- Links Progress Plus workstations end to end to ensure a consistent / fixed gap of 25mm between work surfaces to reduce the risk of finger trapping.

Metalwork

PPFP	- 208w x 180d	_____	£57
-------------	---------------	-------	-----

Progress Plus Accessories

Lead Time: Standard (All products are manufactured to order and when 'Standard Lead Time' is quoted (7 – 10 days), this may vary dependant on volume ordered, factory capacity and distribution requirements at the time of ordering. For more information please contact your Dealer Business Manager or the Customer Services Team for clarification.)



PPCR/SB
Illustrated in red

Progress Plus Double Bench Cable Riser

- Compatible with Progress Plus double benches with double bench cable tray only.
- Connects at pre-fixed points along the workstation / cable tray.

Price

PPCR/SB - Silver / Black	_____	£43
PPCR/BB - Black / Black	_____	£43
PPCR/WB - White / Black	_____	£43



TCRF/SB
Illustrated in red

Progress Plus Double Bench Track Cable Riser

- Compatible with Progress Plus double benches with double bench cable tray only.
- Connects at pre-fixed points along the cable tray and finishes on the floor.

Price

TCRF/SB - Silver / Black	_____	£43
TCRF/BB - Black / Black	_____	£43
TCRF/WB - White / Black	_____	£43



TCR/SB
Illustrated in red

Track Cable Riser

- Connects at pre-determined points located on the underside of the cable tray.
- Free standing steel plate base.

Price

TCR/SB - Silver / Black	_____	£87
TCR/BB - Black / Black	_____	£87
TCR/WB - White / Black	_____	£87

Progress Plus Accessories

Lead Time: Standard (All products are manufactured to order and when 'Standard Lead Time' is quoted (7 – 10 days), this may vary dependant on volume ordered, factory capacity and distribution requirements at the time of ordering. For more information please contact your Dealer Business Manager or the Customer Services Team for clarification.)



PPCPU/W and PPCPU

Progress Plus CPU Holder

- Includes Progress Plus mounting kit.
- Adjustable CPU holder for PC towers.
- Rotates a full 360 degrees for complete access to cables and ports.

	Price
PPCPU - Black Trim	£169
PPCPU/W - White Trim	£169



UMCPU/S
Illustrated in red

Progress Plus Underdesk Mini PC CPU Holder

- Includes Progress Plus mounting kit.
- Progress Plus subframe pre-drilled for central fixing.
- Adjustable underdesk CPU holder to accommodate between 180mm and 235mm wide and up to 38mm high mini PC towers.

	Price
UMCPU/S - Silver Trim - 180-235w (internal) x 210d x 38h (internal)	£152
UMCPU/B - Black Trim - 180-235w (internal) x 210d x 38h (internal)	£152
UMCPU/W - White Trim - 180-235w (internal) x 210d x 38h (internal)	£152



2LM2BS

Showing Bolt Through Version

M2 Monitor Arm

- Post mounted monitor arm with spring assisted tension.

	Price
2LM2CS/TFC - Silver Clamp on Desk Fixing	£304
2LM2CW/TFC - White Clamp on Desk Fixing	£304
• Spring Assisted Tension Height Adjustment	



SCR/S - SCR/B - SCR/W

Slinky Cable Riser

- Suitable for all desking ranges.

	Price
SCR/S - Silver	£59
SCR/B - Black	£59
SCR/W - White	£59

Lead Time: 3 Weeks

Wood: Available in MFC (Ash, Autumn Cherry, Beech, Chester Oak, English Walnut, Grey, Grey Nebraska Oak, Laurentii Wenge, Natural Nebraska Oak and White)
 Top Panel Edge Detail available on 25mm White MFC (Wenge and Black - Add £32 Retail Per Top) (Plywood - Add £42 Retail Per Top)
 Available in Nanotech (Black)

Metalwork: Available in Silver RAL 9006 (Standard), Black Graphite RAL 9004 and White RAL 9003

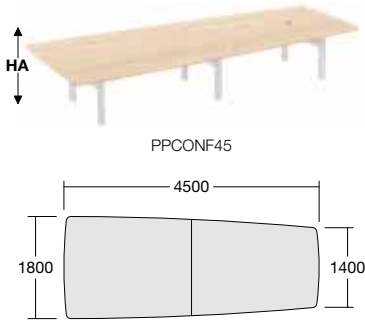

Progress Plus Electric Height Adjustable Half-Barrel Conference Table

- 3 week lead time. • 25mm top panel.
- Sit / stand height adjustment of 650mm-1280mm via electronic up / down keypad situated on the desktop. • Complete with horizontal cable trays. • Anti-collision as standard.

PPCONF45 - 4500w x 1800/1400d x 650-1280h
 • 2x 2250mm Sections • Seating up to 14 People

	MFC	Black Nanotech
	£7,823	£8,519

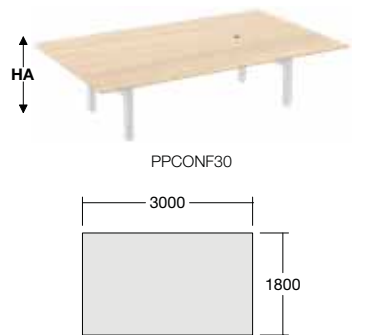

Progress Plus Electric Height Adjustable Rectangular Conference Table

- 3 week lead time. • 25mm top panel.
- Sit / stand height adjustment of 650mm-1280mm via electronic up / down keypad situated on the desktop. • Complete with horizontal cable trays. • Anti-collision as standard.

PPCONF30 - 3000w x 1800d x 650-1280h
 • 1x 3000mm Sections • Seating up to 10 People

MFC

£5,100



Progress Plus Accessory Compatibility

- **BLACK** - Compatible
- **ORANGE** - Non-standard position required
- **BLUE** - Conflict when using screens

Workstations - Height Adjustable Double Benches

Workstations - Height Adjustable Rectangular

Workstations - Height Adjustable 120 Degree Workstations

Meeting - Height Adjustable Conference / Meeting

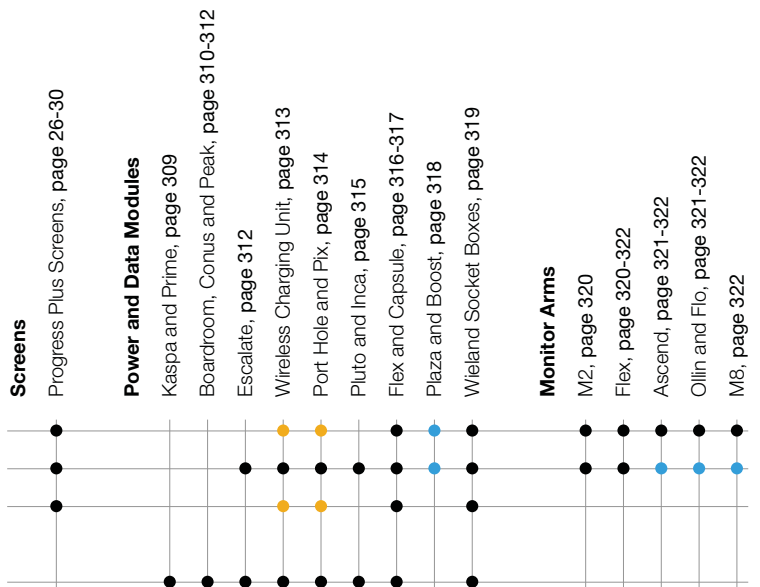

Progress Plus System, Acoustic and Contract Screens for Double Benches

Lead Time: Standard (All products are manufactured to order and when 'Standard Lead Time' is quoted (7 – 10 days), this may vary dependant on volume ordered, factory capacity and distribution requirements at the time of ordering. For more information please contact your Dealer Business Manager or the Customer Services Team for clarification.)

Metalwork: Available in Anodised Silver (Standard), Black Graphite RAL 9004 and White RAL 9003

Fabric: Fully upholstered with pinnable surface available in Groups 1-7

Acrylic: Available in Blue, Green, Orange, Red, Frosted and Clear

MFC: Available in Ash, Autumn Cherry, Beech, Chester Oak, English Walnut, Grey, Grey Nebraska Oak, Laurentii Wenge, Natural Nebraska Oak and White

Progress Plus Desk Mounted System Screen for Double Benches

- Straight dividing screens with aluminium trim.
- Screen is bracketed to the double bench leg frames.
- Link post not required.
- Available as Hygiene Protection Screens and add-ons (see page 28-29).

- For Fabric, suffix ...F
- For Acrylic, suffix ...A
- For MFC, suffix ...MFC



Straight System Screen	Group 1	Group 2	Group 3	Group 4	Group 5	Group 6	Group 7	Acrylic	MFC
PPSS18... - 1662w x 27d x 765h	£593	£605	£617	£629	£641	£653	£665	£593	£550
PPSS16... - 1462w x 27d x 765h	£555	£567	£579	£591	£603	£615	£627	£555	£516
PPSS14... - 1262w x 27d x 765h	£525	£537	£549	£561	£573	£585	£597	£525	£488
PPSS12... - 1062w x 27d x 765h	£497	£509	£521	£533	£545	£557	£569	£497	£458

Progress Plus Desk Mounted Acoustic Screen for Double Benches

- Straight dividing screens faced with 6mm polyester fibre insulation board.
- Screen is bracketed to the double bench leg frames.
- Link post not required.
- Available as Hygiene Protection Screens and add-ons (see page 28-29).

- Class B certified in accordance with International Standards:

- ISO 354:2003
- ISO 11654:1997
- ISO 9613-1:1993



Straight Acoustic Screen	Group 1	Group 2	Group 3	Group 4	Group 5	Group 6	Group 7
APPSS18F - 1662w x 38d x 765h	£732	£744	£756	£768	£780	£792	£804
APPSS16F - 1462w x 38d x 765h	£686	£698	£710	£722	£734	£746	£758
APPSS14F - 1262w x 38d x 765h	£650	£662	£674	£686	£698	£710	£722
APPSS12F - 1062w x 38d x 765h	£616	£628	£640	£652	£664	£676	£688

Progress Plus Desk Mounted Contract Screen for Double Benches

- Straight dividing screens with pinnable or non-pinnable fully upholstered surface.
- Pullover style fabric application.
- Screen is bracketed to the double bench leg frames.
- Link post not required.
- Available as Hygiene Protection Screens and add-ons (see page 28-29).



Straight Pinnable Contract Screen	Group 1	Group 2	Group 3	Group 4	Group 5	Group 6	Group 7
PPPCS18FP - 1662w x 38d x 765h	£419	£431	£443	£455	£467	£479	£491
PPPCS16FP - 1462w x 38d x 765h	£410	£422	£434	£446	£458	£470	£482
PPPCS14FP - 1262w x 38d x 765h	£398	£410	£422	£434	£446	£458	£470
PPPCS12FP - 1062w x 38d x 765h	£386	£398	£410	£422	£434	£446	£458

Straight Non-pinnable Contract Screen

PPPCS18F - 1662w x 25d x 765h	£382	£394	£406	£418	£430	£442	£454
PPPCS16F - 1462w x 25d x 765h	£371	£383	£395	£407	£419	£431	£443
PPPCS14F - 1262w x 25d x 765h	£359	£371	£383	£395	£407	£419	£431
PPPCS12F - 1062w x 25d x 765h	£348	£360	£372	£384	£396	£408	£420

Progress Plus System, Acoustic and 120 Degree Screens for Workstations

Lead Time: Standard (All products are manufactured to order and when 'Standard Lead Time' is quoted (7 – 10 days), this may vary dependant on volume ordered, factory capacity and distribution requirements at the time of ordering. For more information please contact your Dealer Business Manager or the Customer Services Team for clarification.)

Metalwork: Available in Anodised Silver (Standard), Black Graphite RAL 9004 and White RAL 9003

Fabric: Fully upholstered with pinnable surface available in Groups 1-7

Acrylic: Available in Blue, Green, Orange, Red, Frosted and Clear

MFC: Available in Ash, Autumn Cherry, Beech, Chester Oak, English Walnut, Grey, Grey Nebraska Oak, Laurentii Wenge, Natural Nebraska Oak and White

Progress Plus Desk Mounted System Screen for Single Desks

- Straight dividing screens with aluminium trim and optional management rail.
- Screen is bracketed to the outer edge of the desk top.
- Link post not required. • Available as Hygiene Protection Screens and add-ons (see page 28-29).

- For Fabric, suffix ...F
- For Acrylic, suffix ...A
- For MFC without Management Rail, suffix ...MFC
- For MFC with Management Rail, suffix .../MFC



Straight System Screen

	Group 1	Group 2	Group 3	Group 4	Group 5	Group 6	Group 7	Acrylic	MFC
ESS18... - 1773w x 27d x 375h	£419	£431	£443	£455	£467	£479	£491	£419	£382
ESS16... - 1573w x 27d x 375h	£385	£397	£409	£421	£433	£445	£457	£385	£351
ESS14... - 1373w x 27d x 375h	£357	£369	£381	£393	£405	£417	£429	£357	£318
ESS12... - 1173w x 27d x 375h	£325	£337	£349	£361	£373	£385	£397	£325	£295

Straight System Screen with Management Rail

ESS18M... - 1773w x 27d x 375h	£559	£571	£583	£595	£607	£619	£631	£559	£507
ESS16M... - 1573w x 27d x 375h	£516	£528	£540	£552	£564	£576	£588	£516	£469
ESS14M... - 1373w x 27d x 375h	£454	£466	£478	£490	£502	£514	£526	£454	£431
ESS12M... - 1173w x 27d x 375h	£422	£434	£446	£458	£470	£482	£494	£422	£382

Progress Plus Desk Mounted Acoustic Screen for Single Desks

- Straight dividing screens faced with 6mm polyester fibre insulation board.
- Screen is bracketed to the outer edge of the desk top.
- Link post not required.
- Available as Hygiene Protection Screens and add-ons (see page 28-29).

- Class B certified in accordance with International Standards:

- ISO 354:2003
- ISO 11654:1997
- ISO 9613-1:1993



Straight Acoustic Screen

	Group 1	Group 2	Group 3	Group 4	Group 5	Group 6	Group 7
AESS18F - 1773w x 38d x 375h	£526	£538	£550	£562	£574	£586	£598
AESS16F - 1573w x 38d x 375h	£482	£494	£506	£518	£530	£542	£554
AESS14F - 1373w x 38d x 375h	£449	£461	£473	£485	£497	£509	£521
AESS12F - 1173w x 38d x 375h	£409	£421	£433	£445	£457	£469	£481

Progress Plus Desk Mounted System Screen for 120 Degree Workstations

- Straight dividing screens with aluminium trim.
- Screen is fixed to a Link Post at one end and is bracketed to the leg frame at the other.
- 3 way link post required (ELP765/120).
- Available as Hygiene Protection Screens and add-ons (see page 28-29).

- For Fabric, suffix ...F
- For Acrylic, suffix ...A
- For MFC, suffix ...MFC



Straight System Screen

	Group 1	Group 2	Group 3	Group 4	Group 5	Group 6	Group 7	Acrylic	MFC
PPSS120/12... - 1130w x 27d x 765h	£509	£521	£533	£545	£557	£569	£581	£509	£473
PPSS120/10... - 930w x 27d x 765h	£482	£494	£506	£518	£530	£542	£554	£482	£446

Link Post

ELP765/120 - 3 Way	£78
---------------------------	-----

Progress Plus Acrylic Hygiene Protection Screens for Double Benches

Lead Time: Standard (All products are manufactured to order and when 'Standard Lead Time' is quoted (7 – 10 days), this may vary dependant on volume ordered, factory capacity and distribution requirements at the time of ordering. For more information please contact your Dealer Business Manager or the Customer Services Team for clarification.)

Acrylic: Clear

Metalwork: Fixing Brackets supplied in Silver RAL 9006 (Standard) - Optional Black Graphite RAL 9004 and White RAL 9003



Acrylic Illustrated in Blue



PPSS16/HPS
Acrylic Illustrated in Blue

Progress Plus Desk Mounted Acrylic Hygiene Protection Screen for Double Benches with Screens

- Rectangular acrylic dividing screens supplied with brackets.
- Screen is bracketed to the existing screen frame.
- Brackets supplied in Silver RAL 9006 as standard.
- Screens compatible with Non-Elite Desk Mounted Screens available.

Addition for 27mm Progress Plus Desk Mounted System Screen

Product Code	Dimensions	Price
PPSS18/HPS	- 1662w x 5d x 400h	£207
PPSS16/HPS	- 1462w x 5d x 400h	£197
PPSS14/HPS	- 1262w x 5d x 400h	£179
PPSS12/HPS	- 1062w x 5d x 400h	£161



Addition for 38mm Progress Plus Desk Mounted Acoustic Screen

APPSS18F/HPS	- 1662w x 5d x 400h	£207
APPSS16F/HPS	- 1462w x 5d x 400h	£197
APPSS14F/HPS	- 1262w x 5d x 400h	£179
APPSS12F/HPS	- 1062w x 5d x 400h	£161



Addition for 38mm Progress Plus Desk Mounted Contract Screen (Pinnable)

PPPCS18FP/HPS	- 1662w x 5d x 400h	£207
PPPCS16FP/HPS	- 1462w x 5d x 400h	£197
PPPCS14FP/HPS	- 1262w x 5d x 400h	£179
PPPCS12FP/HPS	- 1062w x 5d x 400h	£161



Addition for 27mm Progress Plus Desk Mounted Contract Screen (Non-Pinnable)

PPPCS18F/HPS	- 1662w x 5d x 400h	£207
PPPCS16F/HPS	- 1462w x 5d x 400h	£197
PPPCS14F/HPS	- 1262w x 5d x 400h	£179
PPPCS12F/HPS	- 1062w x 5d x 400h	£161



EHPSE8
Acrylic Illustrated in Blue

Progress Plus Desk Mounted End Return Acrylic Hygiene Protection Screen for Double Benches

- Rectangular acrylic dividing screens supplied with fixing brackets.
- Screen is clamped to the desktop.
- Brackets supplied in Silver RAL 9006 as standard.

Progress Plus Desk Mounted End Return Screen

Product Code	Dimensions	Price
EHPSE8	- 780w x 5d x 700h	£248
EHPSE6	- 580w x 5d x 700h	£222



Progress Plus Acrylic Hygiene Protection Screens for Single Desks and 120 Degree Workstations

Lead Time: Standard (All products are manufactured to order and when 'Standard Lead Time' is quoted (7 – 10 days), this may vary dependant on volume ordered, factory capacity and distribution requirements at the time of ordering. For more information please contact your Dealer Business Manager or the Customer Services Team for clarification.)

Acrylic: Clear

Metalwork: Fixing Brackets supplied in Silver RAL 9006 (Standard) - Optional Black Graphite RAL 9004 and White RAL 9003



EHPS16
Acrylic Illustrated in Blue



EHPS16/O
Acrylic Illustrated in Blue



Progress Plus Desk Mounted Acrylic Hygiene Protection Screen for Single Desks

- Rectangular acrylic dividing screens supplied with fixing brackets.
- Screen is clamped to the desktop.
- Brackets supplied in Silver RAL 9006 as standard.
- For a central opening of 400w x 60h, suffix .../O.

Progress Plus Desk Mounted Screen

	Price
EHPS18 - 1773w x 5d x 700h	£342
EHPS16 - 1573w x 5d x 700h	£316
EHPS14 - 1373w x 5d x 700h	£294
EHPS12 - 1173w x 5d x 700h	£265



ESS16/HPS
Acrylic Illustrated in Blue



Progress Plus Desk Mounted Acrylic Hygiene Protection Screen for Single Desks with Screens

- Rectangular acrylic dividing screens supplied with brackets.
- Screen is bracketed to the existing screen frame.
- Brackets supplied in Silver RAL 9006 as standard.
- Screens compatible with Non-Elite Desk Mounted Screens available.

Addition for 27mm Progress Plus Desk Mounted System Screen

	Price
ESS18/HPS - 1773w x 5d x 325h	£212
ESS16/HPS - 1573w x 5d x 325h	£199
ESS14/HPS - 1373w x 5d x 325h	£189
ESS12/HPS - 1173w x 5d x 325h	£171

Addition for 38mm Progress Plus Desk Mounted Acoustic Screen

AESS18F/HPS - 1773w x 5d x 325h	£212
AESS16F/HPS - 1573w x 5d x 325h	£199
AESS14F/HPS - 1373w x 5d x 325h	£189
AESS12F/HPS - 1173w x 5d x 325h	£171



EHPSER8
Acrylic Illustrated in Blue



Progress Plus Desk Mounted End Return Acrylic Hygiene Protection Screen for Double Benches

- Rectangular acrylic dividing screens supplied with fixing brackets.
- Screen is clamped to the desktop.
- Brackets supplied in Silver RAL 9006 as standard.

Progress Plus Desk Mounted End Return Screen

	Price
EHPSER8 - 780w x 5d x 700h	£248
EHPSER6 - 580w x 5d x 700h	£222



PPSS120/12/HPS
Acrylic Illustrated in Blue



Progress Plus Desk Mounted Acrylic Hygiene Protection Screen for 120 Degree Workstations with Screens

- Rectangular acrylic dividing screens supplied with brackets.
- Screen is bracketed to the existing screen frame.
- Brackets supplied in Silver RAL 9006 as standard.
- Screens compatible with Non-Elite Desk Mounted Screens available.

Addition for 27mm Progress Plus Desk Mounted System Screen

PPSS120/12/HPS - 1130w x 5d x 400h	£184
PPSS120/10/HPS - 930w x 5d x 400h	£163

Progress Plus Blade Screen Panels

Lead Time: Standard (All products are manufactured to order and when 'Standard Lead Time' is quoted (7 – 10 days), this may vary dependant on volume ordered, factory capacity and distribution requirements at the time of ordering. For more information please contact your Dealer Business Manager or the Customer Services Team for clarification.)

Metalwork: Available in Anodised Silver (Standard), Black Graphite RAL 9004 and White RAL 9003

Fabric: Fully upholstered with pinnable surface available in the finishes detailed below

Progress Plus Desk Mounted Blade Screen Panel for All Workstations

- Straight dividing screens.
 - Screen is bracketed to the outer edge of the desk top.
 - Link post not required.
- Black Fabric (.../F1), Grey Fabric (.../F2), Light Grey Fabric (.../F3), Blue Fabric (.../F4) and Red Fabric (.../F5)



Blade Screen Panel

EBS16F/F3

Straight Blade Screen Panel

EBS18F...	- 1180w x 16d x 360h	_____
EBS16F...	- 1180w x 16d x 360h	_____
EBS14F...	- 980w x 16d x 360h	_____
EBS12F...	- 980w x 16d x 360h	_____

Black	Grey	Light Grey	Blue	Red
£147	£147	£147	£147	£147
£147	£147	£147	£147	£147
£130	£130	£130	£130	£130
£130	£130	£130	£130	£130

Progress Plus Desk Mounted Blade Screen / Modesty Panel for Single Desks

- Straight dividing screens with modesty panel overhang.
 - Screen is bracketed to the outer edge of the desk top.
 - Link post not required.
- Black Fabric (.../F1), Grey Fabric (.../F2), Light Grey Fabric (.../F3), Blue Fabric (.../F4) and Red Fabric (.../F5)



Blade Screen / Modesty Panel

EBSMP16F/F3

Straight Blade Screen Panel

EBSMP18F...	- 1180w x 16d x 580h	_____
EBSMP16F...	- 1180w x 16d x 580h	_____

Black	Grey	Light Grey	Blue	Red
£204	£204	£204	£204	£204
£204	£204	£204	£204	£204

Progress Plus Desk Mounted Blade End Return Panel for Single Desks

- Straight dividing screens.
 - Screen is bracketed to the outer edge of the desk top.
 - Link post not required.
- Black Fabric (.../F1), Grey Fabric (.../F2), Light Grey Fabric (.../F3), Blue Fabric (.../F4) and Red Fabric (.../F5)



Blade Screen Panel

EBSER8F/F3

Straight Blade Screen Panel

EBSER8F...	- 580w x 16d x 360h	_____
-------------------	---------------------	-------

Black	Grey	Light Grey	Blue	Red
£98	£98	£98	£98	£98

Blade Screen Panel Finishes



Black (.../F1)



Grey (.../F2)



Light Grey (.../F3)



Blue (.../F4)



Red (.../F5)

Whilst every effort has been made to ensure accurate colours are illustrated in this document, there may be a slight colour difference due to the printing process, therefore please refer to our colour sample swatches prior to ordering.

Progress Gas Strut Sit / Stand Height Adjustable and Fixed Height Workstations



Progress offers complete flexibility with options including fixed height and gas strut height adjustment. Each option can be fitted after the initial installation, should the user's requirements change. For example, a fixed height workstation can be converted to include height adjustment by swapping the leg uprights only. All components are fully interchangeable for maximum flexibility. The sit-stand aspect brings significant health benefits encouraging wellbeing within the office environment. Height adjustable workstations offer height variation from 685mm to 1185mm. Double benches are supplied with sliding tops as standard, enhancing the flexibility of the desking system. Horizontal wire management is inclusive under each desk top on both the single and double benches. Decorative slab end panels can be fitted to both single and double workstations to enhance the aesthetics at the end of a run of workstations, offering a more executive appearance.

Progress How to Specify Height Adjustable Progress Workstations

Introduction

For correct use of Progress gas strut height adjustable sit / stand desks, it is essential to identify the proposed loading for each desk top. Failure to identify the required loading will result in the gas strut experiencing insufficient or excessive force. See illustrations below:

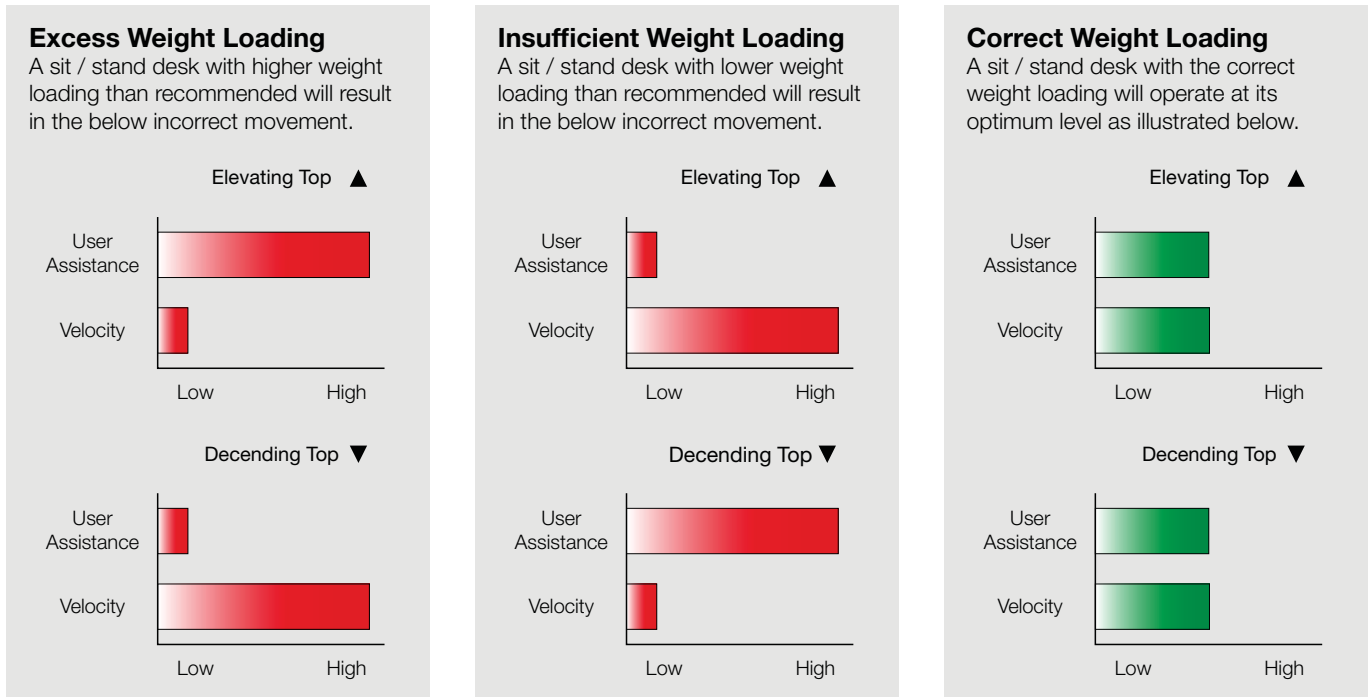

How to Calculate Loading Weights

To find the correct level for all gas strut workstations, you will need to identify the weights to be loaded onto each individual desk top including equipment suspended from its sub-frame.

For Example:

Desktop Monitor, Keyboard, Mouse, CPU Tower, Laptop, Printers, Speakers, Telephone, Accessories, Power Modules, Lighting, etc.

Calculation:

$$\text{Elite Manufactured Items (kg)} + \text{Client Items (kg)} = \text{Total Weight (kg)}$$

Once the total weight is known you can specify the gas strut required from options A-F below. The letter must be suffixed to the desk code you require.

.../A Below 4.9kg	.../B 5.0kg - 9.9kg	.../C 10.0kg - 14.9kg	.../D 15.0kg - 19.9kg	.../E 20.0kg - 24.9kg	.../F 25.0kg - 30.0kg
-----------------------------	-------------------------------	---------------------------------	---------------------------------	---------------------------------	---------------------------------



1600mm Double Bench with 14kg Top Weight on Desktop 1 and 27kg Top Weight on Desktop 2. Gas Strut 'C' and 'F' will need to be specified.

Code: P16/16/HA/C/F



1600mm Single Desk with 8kg Top Weight. Gas Strut 'B' will need to be specified.

Code: PR16/8/HA/B

Lead Time: 6 Weeks

Wood: Available in MFC (Ash, Autumn Cherry, Beech, Chester Oak, English Walnut, Grey, Grey Nebraska Oak, Laurentii Wenge, Natural Nebraska Oak and White)
 Top Panel Edge Detail available on 25mm White MFC (Wenge and Black - Add £32 Retail Per Top) (Plywood - Add £42 Retail Per Top)
 Available in Veneer (Oak and Walnut) on a 3 Week Lead Time

Metalwork: Available in Silver RAL 9006 (Standard) and White RAL 9003



P16/16/HA/.../...

Progress Height Adjustable Double Bench

- 6 week lead time.
- Sit / stand height adjustment of 685mm-1185mm via gas strut release.
- 25mm sliding top panel.
- Complete with 2x horizontal cable trays.
- Suffix below codes with relevant gas strut option (e.g. **PR16/16/HA/C/D**).
- For more technical information, see page 32.

	MFC	Veneer (3 Week Lead Time)
P18/16/HA/.../... - 1800w x 1600d x 685-1185h	£2,299	£2,876
P16/16/HA/.../... - 1600w x 1600d x 685-1185h	£2,268	£2,834
P14/16/HA/.../... - 1400w x 1600d x 685-1185h	£2,228	£2,786

- Loading Weight of 4.9kg and Below (.../A), between 5.0kg - 9.9kg (.../B), between 10.0kg - 14.9kg (.../C), between 15.0kg - 19.9kg (.../D), between 20.0kg - 24.9kg (.../E) and between 25.0kg and Above (.../F)



PR16/8/HA/...

Progress Height Adjustable Rectangular Desk

- 6 week lead time.
- Sit / stand height adjustment of 685mm-1185mm via gas strut release.
- 25mm top panel.
- Complete with a horizontal cable tray.
- Suffix below codes with relevant gas strut option (e.g. **PR16/8/HA/C**).
- For more technical information, see page 32.

	MFC	Veneer (3 Week Lead Time)
PR18/8/HA/... - 1800w x 800d x 685-1185h	£1,098	£1,373
PR16/8/HA/... - 1600w x 800d x 685-1185h	£1,075	£1,343
PR14/8/HA/... - 1400w x 800d x 685-1185h	£1,050	£1,314

- Loading Weight of 4.9kg and Below (.../A), between 5.0kg - 9.9kg (.../B), between 10.0kg - 14.9kg (.../C), between 15.0kg - 19.9kg (.../D), between 20.0kg - 24.9kg (.../E) and between 25.0kg and Above (.../F)



P16/16

Progress Fixed Height Double Bench

- 6 week lead time.
- Complete with 2x horizontal cable trays.
- 25mm sliding top panel.

	MFC	Veneer (3 Week Lead Time)
P18/16 - 1800w x 1600d x 740h	£1,223	£1,530
P16/16 - 1600w x 1600d x 740h	£1,168	£1,462
P14/16 - 1400w x 1600d x 740h	£1,115	£1,394



PR16/8

Progress Fixed Height Rectangular Desk

- 6 week lead time.
- Complete with a horizontal cable tray.
- 25mm top panel.

	MFC	Veneer (3 Week Lead Time)
PR18/8 - 1800w x 800d x 740h	£856	£1,071
PR16/8 - 1600w x 800d x 740h	£825	£1,031
PR14/8 - 1400w x 800d x 740h	£793	£991



P120

Progress Fixed Height 120 Degree Workstation

- 6 week lead time.
- Complete with 6x horizontal cable trays (2x per top).
- 25mm top panel.

	MFC	Veneer (3 Week Lead Time)
P120 - 2920w (dia) x 1200-800d x 740h	£1,753	£2,191

Progress Accessories

Lead Time: Standard (All products are manufactured to order and when 'Standard Lead Time' is quoted (7 – 10 days), this may vary dependant on volume ordered, factory capacity and distribution requirements at the time of ordering. For more information please contact your Dealer Business Manager or the Customer Services Team for clarification.)

Wood: Available in MFC (Ash, Autumn Cherry, Beech, Chester Oak, English Walnut, Grey, Grey Nebraska Oak, Laurentii Wenge, Natural Nebraska Oak and White)
Available in Veneer (Oak and Walnut) on a 3 Week Lead Time

Metalwork: Available in Silver RAL 9006 (Standard) and White RAL 9003



PDDSE

Progress Decorative Slab End

- For use on one end of the workstation (for use on both ends, specify 2x slab ends).
- If ordering for use with the Progress double bench cable tray, suffix .../X.

		MFC	(3 Week Lead Time) Veneer
PDDSE	- For 1600d Ends - 1500w x 97d x 600h	£572	£854
PSDSE	- For 800d Ends - 700w x 97d x 600h	£343	£523



PRMP16
Illustrated in red

Progress Steel Modesty Panel

- Modesty panels are 275mm high.

		Metalwork
PRMP18	- For 1800w Workstations - 1500w - (7.0kg)	£173
PRMP16	- For 1600w Workstations - 1300w - (6.1kg)	£170
PRMP14	- For 1400w Workstations - 1100w - (5.2kg)	£165



PRCT16
Illustrated in red

Progress Double Bench Cable Tray

- Compatible with Progress double benches only.
- Double bench cable trays are 200mm deep and 45mm high.

		Metalwork
PRCT18	- For 1800w Workstations - 1660w	£194
PRCT16	- For 1600w Workstations - 1460w	£179
PRCT14	- For 1400w Workstations - 1260w	£165



PFP
Illustrated in red

Progress Linking Plate

- Links Progress double bench and 120 degree workstations end to end to ensure a consistent / fixed gap of 25mm between work surfaces to reduce the risk of finger trapping.

		Metalwork
PFP	- 188w x 180d	£57

Progress Accessories

Lead Time: Standard (All products are manufactured to order and when 'Standard Lead Time' is quoted (7 – 10 days), this may vary dependant on volume ordered, factory capacity and distribution requirements at the time of ordering. For more information please contact your Dealer Business Manager or the Customer Services Team for clarification.)



PCR/S
Illustrated in red

Progress Double Bench Cable Riser

- Compatible with Progress double benches with double bench cable tray PRCT only.
- Connects to the right or left-hand side of the workstation / cable tray.

Price

PCR/S	- Silver / Black	- (0.4kg)	_____	£87
PCR/B	- Black / Black	- (0.4kg)	_____	£87
PCR/W	- White / Black	- (0.4kg)	_____	£87



PCPU/W and PCPU

Progress CPU Holder

- Includes Progress mounting kit.
- Adjustable CPU holder for PC towers.
- Rotates a full 360 degrees for complete access to cables and ports.

Price

PCPU	- Black Trim	- (3.4kg)	_____	£186
PCPU/W	- White Trim	- (3.4kg)	_____	£186



2LM2BS

Showing Bolt Through Version

M2 Monitor Arm

- Post mounted monitor arm with spring assisted tension.

Price

2LM2CS/TFC	- Silver Clamp on Desk Fixing	- (3.4kg)	_____	£304
2LM2CW/TFC	- White Clamp on Desk Fixing	- (3.4kg)	_____	£304

• Spring Assisted Tension Height Adjustment



SCR/S - SCR/B - SCR/W

Slinky Cable Riser

- Suitable for all desking ranges.

Price

SCR/S	- Silver	_____	£59
SCR/B	- Black	_____	£59
SCR/W	- White	_____	£59

Lead Time: 6 Weeks (Conference / Meeting)

Wood: Available in MFC (Ash, Autumn Cherry, Beech, Chester Oak, English Walnut, Grey, Grey Nebraska Oak, Laurentii Wenge, Natural Nebraska Oak and White)
 Top Panel Edge Detail available on 25mm White MFC (Wenge and Black - Add £32 Retail Per Top) (Plywood - Add £42 Retail Per Top)
 Available in Veneer (Oak and Walnut)

Metalwork: Available in Silver RAL 9006 (Standard) and White RAL 9003
 Also available in Blue RAL 5001, Coral RAL 2001, Green RAL 6016, Light Grey RAL 7038, Teal RAL 5018 and Yellow RAL 1021 (Add 12% for all)



PCONF2

Progress Fixed Height Rectangular Conference Table

• 25mm top panel. • 6 week lead time.

PCONF2 - 3400w x 1200d x 740h
 • 2x 1700mm Sections • Seating up to 10 People

PCONF1B - 2400w x 1200d x 740h
 • 1x 2400mm Sections • Seating up to 8 People

PCONF1A - 2000w x 1200d x 740h
 • 1x 2000mm Sections • Seating up to 8 People

MFC Veneer

£2,084 £2,605

£1,230 £1,539

£1,056 £1,321



PCONF1A



PRMT20/10

Progress Fixed Height Rectangular Meeting Table

• 25mm top panel. • 6 week lead time.

PRMT22/10 - 2200w x 1000d x 740h

PRMT20/10 - 2000w x 1000d x 740h

PRMT20/8 - 2000w x 800d x 740h

MFC Veneer

£1,092 £1,364

£1,030 £1,286

£973 £1,216



PRCT20

Illustrated in red

Progress Meeting Cable Tray

• Compatible with Progress conference and meeting tables only.
 • Meeting cable trays are 100mm deep and 110mm high.

PRCT34 - For PCONF2 - Sold in 2x Sections - 2x 900w

PRCT24 - For PCONF1B - 1300w

PRCT22 - For 2200w Meeting Tables - 1100w

PRCT20 - For PCONF1A and 2000w Meeting Tables - 900w

Metalwork

£227

£147

£129

£113

Progress Accessory Compatibility

- **BLACK** - Compatible
- **ORANGE** - Non-standard position required
- **BLUE** - Conflict when using screens
- **GREEN** - Unspecified

- Workstations** - Height Adjustable Double Benches
- Workstations** - Height Adjustable Rectangular
- Workstations** - Fixed Height Double Benches
- Workstations** - Fixed Height Rectangular
- Workstations** - Fixed Height 120 Degree Cluster

Meeting - Conference / Meeting

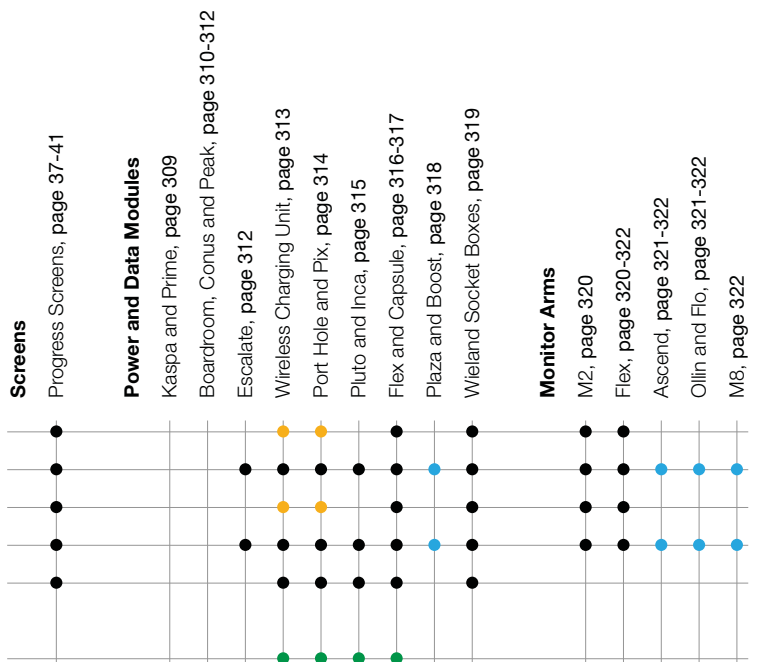

Progress System and Acoustic Screens for Double Benches

Lead Time: Standard (All products are manufactured to order and when 'Standard Lead Time' is quoted (7 – 10 days), this may vary dependant on volume ordered, factory capacity and distribution requirements at the time of ordering. For more information please contact your Dealer Business Manager or the Customer Services Team for clarification.)

Metalwork: Available in Anodised Silver (Standard), Black Graphite RAL 9004 and White RAL 9003

Fabric: Fully upholstered with pinnable surface available in Groups 1-7

Acrylic: Available in Blue, Green, Orange, Red, Frosted and Clear

MFC: Available in Ash, Autumn Cherry, Beech, Chester Oak, English Walnut, Grey, Grey Nebraska Oak, Laurentii Wenge, Natural Nebraska Oak and White

Progress Desk Mounted System Screen for Double Benches

- Straight dividing screens with aluminium trim.
- Screen is bracketed to the double bench leg frames.
- Link post not required.
- Available as Hygiene Protection Screens and add-ons (see page 39-40).



System Screens

PSS16F

- For Fabric, suffix ...F
- For Acrylic, suffix ...A
- For MFC, suffix ...MFC

Straight System Screen

	Group 1	Group 2	Group 3	Group 4	Group 5	Group 6	Group 7	Acrylic	MFC
PSS18... - 1653w x 27d x 600h	£565	£577	£589	£601	£613	£625	£637	£565	£525
PSS16... - 1453w x 27d x 600h	£529	£541	£553	£565	£577	£589	£601	£529	£491
PSS14... - 1253w x 27d x 600h	£500	£512	£524	£536	£548	£560	£572	£500	£465

Progress Desk Mounted Acoustic Screen for Double Benches

- Straight dividing screens faced with 6mm polyester fibre insulation board.
- Screen is bracketed to the double bench leg frames.
- Link post not required.
- Available as Hygiene Protection Screens and add-ons (see page 39-40).

- Class B certified in accordance with International Standards:

- ISO 354:2003
- ISO 11654:1997
- ISO 9613-1:1993



Acoustic Screens



APSS16F

Straight Acoustic Screen

	Group 1	Group 2	Group 3	Group 4	Group 5	Group 6	Group 7
APSS18F - 1653w x 38d x 600h	£705	£717	£729	£741	£753	£765	£777
APSS16F - 1453w x 38d x 600h	£661	£673	£685	£697	£709	£721	£733
APSS14F - 1253w x 38d x 600h	£624	£636	£648	£660	£672	£684	£696



Progress System and Acoustic Screens for Single Workstations

Lead Time: Standard (All products are manufactured to order and when 'Standard Lead Time' is quoted (7 – 10 days), this may vary dependant on volume ordered, factory capacity and distribution requirements at the time of ordering. For more information please contact your Dealer Business Manager or the Customer Services Team for clarification.)

Metalwork: Available in Anodised Silver (Standard), Black Graphite RAL 9004 and White RAL 9003

Fabric: Fully upholstered with pinnable surface available in Groups 1-7

Acrylic: Available in Blue, Green, Orange, Red, Frosted and Clear

MFC: Available in Ash, Autumn Cherry, Beech, Chester Oak, English Walnut, Grey, Grey Nebraska Oak, Laurentii Wenge, Natural Nebraska Oak and White

Progress Desk Mounted System Screen for Single Desks

- Straight dividing screens with aluminium trim and optional management rail.
- Screen is bracketed to the outer edge of the desk top.
- Link post not required. • Available as Hygiene Protection Screens and add-ons (see page 39-40).

- For Fabric, suffix ...F
- For Acrylic, suffix ...A
- For MFC without Management Rail, suffix ...MFC
- For MFC with Management Rail, suffix .../MFC



System Screens



System Screens with Management Rail



ESS16F

Straight System Screen

	Group 1	Group 2	Group 3	Group 4	Group 5	Group 6	Group 7	Acrylic	MFC
ESS18... - 1773w x 27d x 375h (F - 7.8kg, A - 5.0kg and MFC - 11.4kg)	£419	£431	£443	£455	£467	£479	£491	£419	£382
ESS16... - 1573w x 27d x 375h (F - 6.6kg, A - 3.8kg and MFC - 10.2kg)	£385	£397	£409	£421	£433	£445	£457	£385	£351
ESS14... - 1373w x 27d x 375h (F - 5.4kg, A - 2.6kg and MFC - 9.0kg)	£357	£369	£381	£393	£405	£417	£429	£357	£318

Straight System Screen with Management Rail

ESS18M... - 1773w x 27d x 375h (F - 7.8kg, A - 5.0kg and MFC - 11.4kg)	£559	£571	£583	£595	£607	£619	£631	£559	£507
ESS16M... - 1573w x 27d x 375h (F - 6.6kg, A - 3.8kg and MFC - 10.2kg)	£516	£528	£540	£552	£564	£576	£588	£516	£469
ESS14M... - 1373w x 27d x 375h (F - 5.4kg, A - 2.6kg and MFC - 9.0kg)	£454	£466	£478	£490	£502	£514	£526	£454	£431

Progress Desk Mounted Acoustic Screen for Single Desks

- Straight dividing screens faced with 6mm polyester fibre insulation board.
- Screen is bracketed to the outer edge of the desk top.
- Link post not required.
- Available as Hygiene Protection Screens and add-ons (see page 39-40).

- Class B certified in accordance with International Standards:

- ISO 354:2003
- ISO 11654:1997
- ISO 9613-1:1993



Acoustic Screens



AESS16F

Straight Acoustic Screen

	Group 1	Group 2	Group 3	Group 4	Group 5	Group 6	Group 7		
AESS18F - 1773w x 38d x 375h - (8.5kg)	£526	£538	£550	£562	£574	£586	£598		
AESS16F - 1573w x 38d x 375h - (7.6kg)	£482	£494	£506	£518	£530	£542	£554		
AESS14F - 1373w x 38d x 375h - (6.8kg)	£449	£461	£473	£485	£497	£509	£521		

Progress Desk Mounted System Screen for 120 Degree Workstations

- Straight dividing screens with aluminium trim.
- Screen is fixed to a Link Post at one end and is bracketed to the leg frame at the other.
- 3 way link post required (ELP600/120).
- Available as Hygiene Protection Screens and add-ons (see page 39-40).

- For Fabric, suffix ...F
- For Acrylic, suffix ...A
- For MFC, suffix ...MFC



System Screens



PSS120/12F

Straight System Screen

	Group 1	Group 2	Group 3	Group 4	Group 5	Group 6	Group 7	Acrylic	MFC
PSS120/12... - 1110w x 27d x 600h	£484	£496	£508	£520	£532	£544	£556	£484	£452

Link Post

ELP600/120 - 3 Way	£78
---------------------------	-----

Progress Acrylic Hygiene Protection Screens for Double Benches

Lead Time: Standard (All products are manufactured to order and when 'Standard Lead Time' is quoted (7 – 10 days), this may vary dependant on volume ordered, factory capacity and distribution requirements at the time of ordering. For more information please contact your Dealer Business Manager or the Customer Services Team for clarification.)

Acrylic: Clear

Metalwork: Fixing Brackets supplied in Silver RAL 9006 (Standard) - Optional Black Graphite RAL 9004 and White RAL 9003



Acrylic Illustrated in Blue



PSS16/HPS
Acrylic Illustrated in Blue



Progress Desk Mounted Acrylic Hygiene Protection Screen for Double Benches with Screens

- Rectangular acrylic dividing screens supplied with brackets.
- Screen is bracketed to the existing screen frame.
- Brackets supplied in Silver RAL 9006 as standard.
- Screens compatible with Non-Elite Desk Mounted Screens available.

Addition for 27mm Progress Desk Mounted System Screen

PSS18/HPS - 1653w x 5d x 400h	_____	Price
PSS16/HPS - 1453w x 5d x 400h	_____	£207
PSS14/HPS - 1253w x 5d x 400h	_____	£197
		£179

Addition for 38mm Progress Desk Mounted Acoustic Screen

APSS18F/HPS - 1653w x 5d x 400h	_____	£207
APSS16F/HPS - 1453w x 5d x 400h	_____	£197
APSS14F/HPS - 1253w x 5d x 400h	_____	£179



EHPSER8
Acrylic Illustrated in Blue



Progress Desk Mounted End Return Acrylic Hygiene Protection Screen for Double Benches

- Rectangular acrylic dividing screens supplied with fixing brackets.
- Screen is clamped to the desktop.
- Brackets supplied in Silver RAL 9006 as standard.

Progress Desk Mounted End Return Screen

EHPSER8 - 780w x 5d x 700h	_____	Price
		£248

Progress Acrylic Hygiene Protection Screens for Single Desks and 120 Degree Workstations

Lead Time: Standard (All products are manufactured to order and when 'Standard Lead Time' is quoted (7 – 10 days), this may vary dependant on volume ordered, factory capacity and distribution requirements at the time of ordering. For more information please contact your Dealer Business Manager or the Customer Services Team for clarification.)

Acrylic: Clear

Metalwork: Fixing Brackets supplied in Silver RAL 9006 (Standard) - Optional Black Graphite RAL 9004 and White RAL 9003



EHPS16
Acrylic Illustrated in Blue



Progress Desk Mounted Acrylic Hygiene Protection Screen for Single Desks

- Rectangular acrylic dividing screens supplied with fixing brackets.
- Screen is clamped to the desktop.
- Brackets supplied in Silver RAL 9006 as standard.
- For a central opening of 400w x 60h, suffix .../O.

Progress Desk Mounted Screen

EHPS18 - 1773w x 5d x 700h _____

EHPS16 - 1573w x 5d x 700h _____

EHPS14 - 1373w x 5d x 700h _____

Price

£342

£316

£294



ESS16/HPS
Acrylic Illustrated in Blue



Progress Desk Mounted Acrylic Hygiene Protection Screen for Single Desks with Screens

- Rectangular acrylic dividing screens supplied with brackets.
- Screen is bracketed to the existing screen frame.
- Brackets supplied in Silver RAL 9006 as standard.
- Screens compatible with Non-Elite Desk Mounted Screens available.

Addition for 27mm Progress Desk Mounted System Screen

ESS18/HPS - 1773w x 5d x 325h _____

ESS16/HPS - 1573w x 5d x 325h _____

ESS14/HPS - 1373w x 5d x 325h _____

Price

£212

£199

£189

Addition for 38mm Progress Desk Mounted Acoustic Screen

AESS18F/HPS - 1773w x 5d x 325h _____

AESS16F/HPS - 1573w x 5d x 325h _____

AESS14F/HPS - 1373w x 5d x 325h _____

£212

£199

£189



EHPSE8
Acrylic Illustrated in Blue



Progress Desk Mounted End Return Acrylic Hygiene Protection Screen for Double Benches

- Rectangular acrylic dividing screens supplied with fixing brackets.
- Screen is clamped to the desktop.
- Brackets supplied in Silver RAL 9006 as standard.

Progress Desk Mounted End Return Screen

EHPSE8 - 780w x 5d x 700h _____

Price

£248



PSS120/12/HPS
Acrylic Illustrated in Blue



Progress Desk Mounted Acrylic Hygiene Protection Screen for 120 Degree Workstations with Screens

- Rectangular acrylic dividing screens supplied with brackets.
- Screen is bracketed to the existing screen frame.
- Brackets supplied in Silver RAL 9006 as standard.
- Screens compatible with Non-Elite Desk Mounted Screens available.

Addition for 27mm Progress Desk Mounted System Screen

PSS120/12/HPS - 1130w x 5d x 400h _____

Price

£184

Progress Blade Screen Panels

Lead Time: Standard (All products are manufactured to order and when 'Standard Lead Time' is quoted (7 – 10 days), this may vary dependant on volume ordered, factory capacity and distribution requirements at the time of ordering. For more information please contact your Dealer Business Manager or the Customer Services Team for clarification.)

Metalwork: Available in Anodised Silver (Standard), Black Graphite RAL 9004 and White RAL 9003

Fabric: Fully upholstered with pinnable surface available in the finishes detailed below

Progress Desk Mounted Blade Screen Panel for All Workstations

- Straight dividing screens.
 - Screen is bracketed to the outer edge of the desk top.
 - Link post not required.
- Black Fabric (.../F1), Grey Fabric (.../F2), Light Grey Fabric (.../F3), Blue Fabric (.../F4) and Red Fabric (.../F5)



Straight Blade Screen Panel

EBS18F...	- 1180w x 16d x 360h	_____
EBS16F...	- 1180w x 16d x 360h	_____
EBS14F...	- 980w x 16d x 360h	_____
EBS12F...	- 980w x 16d x 360h	_____

Black	Grey	Light Grey	Blue	Red
£147	£147	£147	£147	£147
£147	£147	£147	£147	£147
£130	£130	£130	£130	£130
£130	£130	£130	£130	£130

Progress Desk Mounted Blade Screen / Modesty Panel for Single Desks

- Straight dividing screens with modesty panel overhang.
 - Screen is bracketed to the outer edge of the desk top.
 - Link post not required.
- Black Fabric (.../F1), Grey Fabric (.../F2), Light Grey Fabric (.../F3), Blue Fabric (.../F4) and Red Fabric (.../F5)



Straight Blade Screen Panel

EBSMP18F...	- 1180w x 16d x 580h	_____
EBSMP16F...	- 1180w x 16d x 580h	_____

Black	Grey	Light Grey	Blue	Red
£204	£204	£204	£204	£204
£204	£204	£204	£204	£204

Progress Desk Mounted Blade End Return Panel for Single Desks

- Straight dividing screens.
 - Screen is bracketed to the outer edge of the desk top.
 - Link post not required.
- Black Fabric (.../F1), Grey Fabric (.../F2), Light Grey Fabric (.../F3), Blue Fabric (.../F4) and Red Fabric (.../F5)



Straight Blade Screen Panel

EBSER8F...	- 580w x 16d x 360h	_____
-------------------	---------------------	-------

Black	Grey	Light Grey	Blue	Red
£98	£98	£98	£98	£98

Blade Screen Panel Finishes



Black (.../F1) **Grey (.../F2)** **Light Grey (.../F3)** **Blue (.../F4)** **Red (.../F5)**

Progress Lite Manual Sit / Sit Height Adjustable Workstations



Progress Lite is a height adjustable double bench, inclusive of a horizontal cable tray under each desk top. The system offers height adjustment from 650mm to 850mm via a rotating crank handle that can be folded into a recess within the frame, when not in use. Screen panels are compatible with Progress Lite providing the flexibility to segregate each user's space.

Lead Time: 6 Weeks

Wood: Available in MFC (Ash, Autumn Cherry, Beech, Chester Oak, English Walnut, Grey, Grey Nebraska Oak, Laurentii Wenge, Natural Nebraska Oak and White)
 Top Panel Edge Detail available on 25mm White MFC (Wenge and Black - Add £32 Retail Per Top) (Plywood - Add £42 Retail Per Top)
 Available in Veneer (Oak and Walnut)

Metalwork: Available in Silver RAL 9006 (Standard) and White RAL 9003



PL16/16/HA

Progress Lite Height Adjustable Double Bench

- 6 week lead time.
- Sit / sit height adjustment of 650mm-850mm via crank handle.
- 25mm non-sliding top panel.
- Complete with 2x horizontal cable trays.

	MFC	Veneer
PL18/16/HA - 1800w x 1600d x 650-850h	£2,277	£3,086
PL16/16/HA - 1600w x 1600d x 650-850h	£2,203	£2,934
PL14/16/HA - 1400w x 1600d x 650-850h	£2,128	£2,783



PLFP
 Illustrated in red

Progress Lite Linking Plate

- Links Progress Lite double benches end to end to ensure a consistent / fixed gap of 15mm between worksurfaces to reduce the risk of finger trapping.

	Metalwork
PLFP - 188w x 180d	£57



PLCPU/W and PLCPU

Progress Lite CPU Holder

- Includes Progress Lite mounting kit.
- Adjustable CPU holder for PC towers.
- Rotates a full 360 degrees for complete access to cables and ports.

	Price
PLCPU - Black Trim	£186
PLCPU/W - White Trim	£186



2LM2BS

Showing Bolt Through Version

M2 Monitor Arm

- Post mounted monitor arm with spring assisted tension.

	Price
2LM2CS/TFC - Silver Clamp on Desk Fixing	£304
2LM2CW/TFC - White Clamp on Desk Fixing	£304

- Spring Assisted Tension Height Adjustment



SCR/S - SCR/B - SCR/W

Slinky Cable Riser

- Suitable for all desking ranges.

	Price
SCR/S - Silver	£59
SCR/B - Black	£59
SCR/W - White	£59

Progress Lite Accessory Compatibility

- **BLACK** - Compatible
- **BLUE** - Conflict when using screens

Workstations - Height Adjustable Double Benches

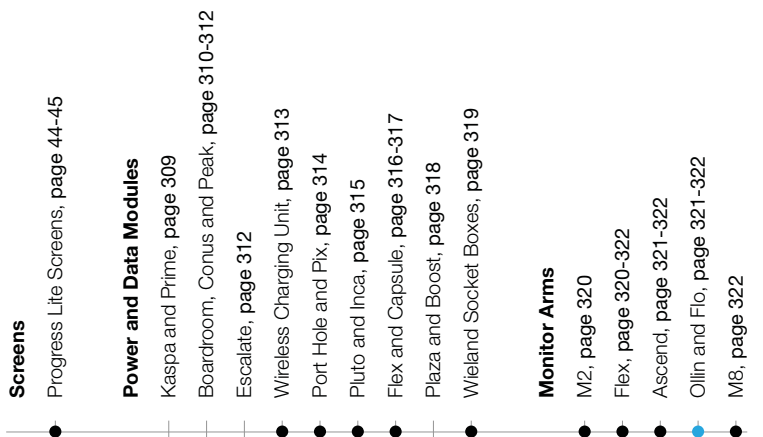

Progress Lite System and Acoustic Screens for Double Benches

Lead Time: Standard (All products are manufactured to order and when 'Standard Lead Time' is quoted (7 – 10 days), this may vary dependant on volume ordered, factory capacity and distribution requirements at the time of ordering. For more information please contact your Dealer Business Manager or the Customer Services Team for clarification.)

Metalwork: Available in Anodised Silver (Standard), Black Graphite RAL 9004 and White RAL 9003

Fabric: Fully upholstered with pinnable surface available in Groups 1-7

Acrylic: Available in Blue, Green, Orange, Red, Frosted and Clear

MFC: Available in Ash, Autumn Cherry, Beech, Chester Oak, English Walnut, Grey, Grey Nebraska Oak, Laurentii Wenge, Natural Nebraska Oak and White

Progress Lite Desk Mounted System Screen for Double Benches

- Straight dividing screens with aluminium trim and optional management rail.
- Screen is bracketed to the double bench leg frames.
- Link post not required. • Available as Hygiene Protection Screens and add-ons (see page 45).

- For Fabric, suffix ...F
- For Acrylic, suffix ...A
- For MFC without Management Rail, suffix ...MFC
- For MFC with Management Rail, suffix .../MFC



System Screens



System Screens with Management Rail



PLSS16F

Straight System Screen

	Group 1	Group 2	Group 3	Group 4	Group 5	Group 6	Group 7	Acrylic	MFC
PLSS18... - 1707w x 27d x 550h	£565	£577	£589	£601	£613	£625	£637	£565	£525
PLSS16... - 1507w x 27d x 550h	£529	£541	£553	£565	£577	£589	£601	£529	£491
PLSS14... - 1307w x 27d x 550h	£500	£512	£524	£536	£548	£560	£572	£500	£466

Straight System Screen with Management Rail

PLSS18M... - 1707w x 27d x 550h	£704	£716	£728	£740	£752	£764	£776	£704	£649
PLSS16M... - 1507w x 27d x 550h	£659	£671	£683	£695	£707	£719	£731	£659	£611
PLSS14M... - 1307w x 27d x 550h	£597	£609	£621	£633	£645	£657	£669	£597	£555

Progress Lite Desk Mounted Acoustic Screen for Double Benches

- Straight dividing screens faced with 6mm polyester fibre insulation board.
- Screen is bracketed to the double bench leg frames.
- Link post not required.
- Available as Hygiene Protection Screens and add-ons (see page 45).

• Class B certified in accordance with International Standards:

- ISO 354:2003
- ISO 11654:1997
- ISO 9613-1:1993



Acoustic Screens



APLSS16F

Straight Acoustic Screen

	Group 1	Group 2	Group 3	Group 4	Group 5	Group 6	Group 7
APLSS18F - 1707w x 38d x 550h	£705	£717	£729	£741	£753	£765	£777
APLSS16F - 1507w x 38d x 550h	£661	£673	£685	£697	£709	£721	£733
APLSS14F - 1307w x 38d x 550h	£624	£636	£648	£660	£672	£684	£696

Progress Lite Acrylic Hygiene Protection Screens for Double Benches

Lead Time: Standard (All products are manufactured to order and when 'Standard Lead Time' is quoted (7 – 10 days), this may vary dependant on volume ordered, factory capacity and distribution requirements at the time of ordering. For more information please contact your Dealer Business Manager or the Customer Services Team for clarification.)

Acrylic: Clear

Metalwork: Fixing Brackets supplied in Silver RAL 9006 (Standard) - Optional Black Graphite RAL 9004 and White RAL 9003



Acrylic Illustrated in Blue



PLSS16/HPS
Acrylic Illustrated in Blue



Progress Lite Desk Mounted Acrylic Hygiene Protection Screen for Double Benches with Screens

- Rectangular acrylic dividing screens supplied with brackets.
- Screen is bracketed to the existing screen frame.
- Brackets supplied in Silver RAL 9006 as standard.
- Screens compatible with Non-Elite Desk Mounted Screens available.

Addition for 27mm Progress Lite Desk Mounted System Screen

PLSS18/HPS - 1707w x 5d x 400h	_____	Price
PLSS16/HPS - 1507w x 5d x 400h	_____	£207
PLSS14/HPS - 1307w x 5d x 400h	_____	£197
		£179

Addition for 38mm Progress Lite Desk Mounted Acoustic Screen

APLSS18F/HPS - 1707w x 5d x 400h	_____	£207
APLSS16F/HPS - 1507w x 5d x 400h	_____	£197
APLSS14F/HPS - 1307w x 5d x 400h	_____	£179



EHPSE8
Acrylic Illustrated in Blue



Progress Lite Desk Mounted End Return Acrylic Hygiene Protection Screen for Double Benches

- Rectangular acrylic dividing screens supplied with fixing brackets.
- Screen is clamped to the desktop.
- Brackets supplied in Silver RAL 9006 as standard.

Progress Lite Desk Mounted End Return Screen

EHPSE8 - 780w x 5d x 700h	_____	Price
		£248

Linnea Elevate Fixed Height Workstations



The Linnea Elevate range includes single and double benches. Horizontal wire management is standard on each workstation with the added feature of sliding tops for simple access to cables. Decorative slab end panels are options that enhance the appearance of the legs and provide added privacy when configured in clusters. Other options include modesty panels for single workstations and horizontal wire management trays for double benches, providing a dynamic facility to house complex cable installations.

Lead Time: 2 Weeks

Wood: Available in MFC (Ash, Autumn Cherry, Beech, Chester Oak, English Walnut, Grey, Grey Nebraska Oak, Laurentii Wenge, Natural Nebraska Oak and White)
Top Panel Edge Detail available on 25mm White MFC (Wenge and Black - Add £32 Retail Per Top) (Plywood - Add £42 Retail Per Top)
Available in Veneer (Oak and Walnut) on a 3 Week Lead Time

Metalwork: Available in Silver RAL 9006 (Standard), Black Graphite RAL 9004 and White RAL 9003



LE18/16

Linnea Elevate Fixed Height Double Bench

- 2 week lead time. • Fixed height. • Complete with 2x horizontal cable trays.
- 25mm sliding top panel. • Actual top width is 10mm less than frame size stated.

	MFC	Veneer (3 Week Lead Time)
LE18/16 - 1800w x 1600d x 740h	£1,570	£1,954
LE16/16 - 1600w x 1600d x 740h	£1,539	£1,918
LE14/16 - 1400w x 1600d x 740h	£1,506	£1,886
LE12/16 - 1200w x 1600d x 740h	£1,477	£1,853



LE18/16/INT

Linnea Elevate Fixed Height Double Bench with Shared Inset Leg

- 2 week lead time. • Fixed height. • Complete with 2x horizontal cable trays.
- 25mm sliding top panel. • Actual top width is 10mm less than frame size stated.

	MFC	Veneer (3 Week Lead Time)
LE18/16/INT - 1800w x 1600d x 740h	£1,539	£1,918
LE16/16/INT - 1600w x 1600d x 740h	£1,506	£1,886
LE14/16/INT - 1400w x 1600d x 740h	£1,474	£1,852
LE12/16/INT - 1200w x 1600d x 740h	£1,442	£1,822



LER18/8

Linnea Elevate Fixed Height Rectangular Desk

- 2 week lead time. • Fixed height. • Complete with a horizontal cable tray.
- 25mm sliding top panel. • Actual top width is 10mm less than frame size stated.

	MFC	Veneer (3 Week Lead Time)
LER18/8 - 1800w x 800d x 740h	£890	£1,248
LER16/8 - 1600w x 800d x 740h	£872	£1,231
LER14/8 - 1400w x 800d x 740h	£859	£1,216
LER12/8 - 1200w x 800d x 740h	£843	£1,199



LER18/8/INT

Linnea Elevate Fixed Height Rectangular Desk with Shared Inset Leg

- 2 week lead time. • Fixed height. • Complete with a horizontal cable tray.
- 25mm sliding top panel. • Actual top width is 10mm less than frame size stated.

	MFC	Veneer (3 Week Lead Time)
LER18/8/INT - 1800w x 800d x 740h	£890	£1,248
LER16/8/INT - 1600w x 800d x 740h	£872	£1,231
LER14/8/INT - 1400w x 800d x 740h	£859	£1,216
LER12/8/INT - 1200w x 800d x 740h	£843	£1,199

Linnea Elevate Accessories

Lead Time: Standard (All products are manufactured to order and when 'Standard Lead Time' is quoted (7 – 10 days), this may vary dependant on volume ordered, factory capacity and distribution requirements at the time of ordering. For more information please contact your Dealer Business Manager or the Customer Services Team for clarification.)

Wood: Available in MFC (Ash, Autumn Cherry, Beech, Chester Oak, English Walnut, Grey, Grey Nebraska Oak, Laurentii Wenge, Natural Nebraska Oak and White)
Available in Veneer (Oak and Walnut) on a 3 Week Lead Time

Metalwork: Available in Silver RAL 9006 (Standard), Black Graphite RAL 9004 and White RAL 9003



LEDDSE

Linnea Elevate Decorative Slab End

- For use on one end of the workstation (for use on both ends, specify 2x slab ends).
- Cannot be retrofitted.

		MFC	Veneer (3 Week Lead Time)
LEDDSE	- For 1600d Ends	£331	£445
LESDSELH	- For 800d Ends	£272	£359
LESDSERH	- For 800d Ends	£272	£359



LERMP16
Illustrated in red

Linnea Elevate Steel Modesty Panel

- Modesty panels are 305mm high.

			Metalwork
LERMP18	- For 1800w Workstations	- 1675w	£180
LERMP16	- For 1600w Workstations	- 1475w	£176
LERMP14	- For 1400w Workstations	- 1275w	£173
LERMP12	- For 1200w Workstations	- 1075w	£170



LERCT16
Illustrated in red

Linnea Elevate High Capacity Cable Tray

- Compatible with Linnea Elevate double benches only.
- Cable trays are 350mm deep and 80mm high.

			Metalwork
LERCT18	- For 1800w Workstations	- 1600w	£194
LERCT16	- For 1600w Workstations	- 1400w	£179
LERCT14	- For 1400w Workstations	- 1200w	£165
LERCT12	- For 1200w Workstations	- 1000w	£151

Linnea Elevate Accessories

Lead Time: Standard (All products are manufactured to order and when 'Standard Lead Time' is quoted (7 – 10 days), this may vary dependant on volume ordered, factory capacity and distribution requirements at the time of ordering. For more information please contact your Dealer Business Manager or the Customer Services Team for clarification.)



LECPU/W and LECPU

Linnea Elevate CPU Holder

- Includes Linnea Elevate mounting kit.
- Adjustable CPU holder for PC towers.
- Rotates a full 360 degrees for complete access to cables and ports.

	Finish
LECPU - Black Trim	£186
LECPU/W - White Trim	£186



2LM2BS

Showing Bolt Through Version

M2 Monitor Arm

- Post mounted monitor arm with spring assisted tension.

	Price
2LM2CS/TFC - Silver Clamp on Desk Fixing	£304
2LM2CW/TFC - White Clamp on Desk Fixing	£304

- Spring Assisted Tension Height Adjustment



SCR/S - SCR/B - SCR/W

Slinky Cable Riser

- Suitable for all desking ranges.

	Price
SCR/S - Silver	£59
SCR/B - Black	£59
SCR/W - White	£59

Linnea Elevate Accessory Compatibility

- **BLACK** - Compatible
- **BLUE** - Conflict when using screens

Workstations - Fixed Height Double Benches

Workstations - Fixed Height Rectangular

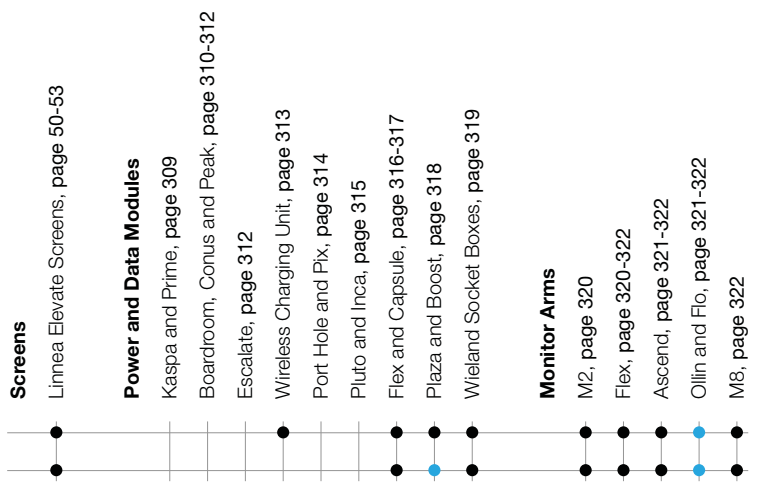

Linnea Elevate System and Acoustic Screens for Double Benches

Lead Time: Standard (All products are manufactured to order and when 'Standard Lead Time' is quoted (7 – 10 days), this may vary dependant on volume ordered, factory capacity and distribution requirements at the time of ordering. For more information please contact your Dealer Business Manager or the Customer Services Team for clarification.)

Metalwork: Available in Anodised Silver (Standard), Black Graphite RAL 9004 and White RAL 9003

Fabric: Fully upholstered with pinnable surface available in Groups 1-7

Acrylic: Available in Blue, Green, Orange, Red, Frosted and Clear

MFC: Available in Ash, Autumn Cherry, Beech, Chester Oak, English Walnut, Grey, Grey Nebraska Oak, Laurentii Wenge, Natural Nebraska Oak and White

Linnea Elevate Desk Mounted System Screen for Double Benches

- Straight dividing screens with aluminium trim and optional management rail.
- Screen is bracketed to the double bench leg frames.
- Link post not required. • Available as Hygiene Protection Screens and add-ons (see page 52-53).

- For Fabric, suffix ...F
- For Acrylic, suffix ...A
- For MFC without Management Rail, suffix ...MFC
- For MFC with Management Rail, suffix .../MFC



System Screens



System Screens with Management Rail



LESS16F

Straight System Screen

	Group 1	Group 2	Group 3	Group 4	Group 5	Group 6	Group 7	Acrylic	MFC
LESS18... - 1707w x 27d x 550h	£438	£450	£462	£474	£486	£498	£510	£438	£396
LESS16... - 1507w x 27d x 550h	£400	£412	£424	£436	£448	£460	£472	£400	£363
LESS14... - 1307w x 27d x 550h	£371	£383	£395	£407	£419	£431	£443	£371	£337
LESS12... - 1107w x 27d x 550h	£339	£351	£363	£375	£387	£399	£411	£339	£321

Straight System Screen with Management Rail

LESS18M... - 1707w x 27d x 550h	£580	£592	£604	£616	£628	£640	£652	£580	£530
LESS16M... - 1507w x 27d x 550h	£536	£548	£560	£572	£584	£596	£608	£536	£490
LESS14M... - 1307w x 27d x 550h	£473	£485	£497	£509	£521	£533	£545	£473	£449
LESS12M... - 1107w x 27d x 550h	£442	£454	£466	£478	£490	£502	£514	£442	£400

Linnea Elevate Desk Mounted Acoustic Screen for Double Benches

- Straight dividing screens faced with 6mm polyester fibre insulation board.
- Screen is bracketed to the double bench leg frames.
- Link post not required.
- Available as Hygiene Protection Screens and add-ons (see page 52-53).

- Class B certified in accordance with International Standards:

- ISO 354:2003
- ISO 11654:1997
- ISO 9613-1:1993



Acoustic Screens



ALESS16F

Straight Acoustic Screen

	Group 1	Group 2	Group 3	Group 4	Group 5	Group 6	Group 7
ALESS18F - 1707w x 38d x 550h	£545	£557	£569	£581	£593	£605	£617
ALESS16F - 1507w x 38d x 550h	£500	£512	£524	£536	£548	£560	£572
ALESS14F - 1307w x 38d x 550h	£465	£477	£489	£501	£513	£525	£537
ALESS12F - 1107w x 38d x 550h	£424	£436	£448	£460	£472	£484	£496

Linnea Elevate System and Acoustic Screens for Single Desks

Lead Time: Standard (All products are manufactured to order and when 'Standard Lead Time' is quoted (7 – 10 days), this may vary dependant on volume ordered, factory capacity and distribution requirements at the time of ordering. For more information please contact your Dealer Business Manager or the Customer Services Team for clarification.)

Metalwork: Available in Anodised Silver (Standard), Black Graphite RAL 9004 and White RAL 9003

Fabric: Fully upholstered with pinnable surface available in Groups 1-7

Acrylic: Available in Blue, Green, Orange, Red, Frosted and Clear

MFC: Available in Ash, Autumn Cherry, Beech, Chester Oak, English Walnut, Grey, Grey Nebraska Oak, Laurentii Wenge, Natural Nebraska Oak and White

Linnea Elevate Desk Mounted System Screen for Single Desks

- Straight dividing screens with aluminium trim and optional management rail.
- Screen is bracketed to the outer edge of the desk top.
- Link post not required. • Available as Hygiene Protection Screens and add-ons (see page 52-53).

- For Fabric, suffix **...F/EF**
- For Acrylic, suffix **...A/EF**
- For MFC without Management Rail, suffix **...MFC/EF**
- For MFC with Management Rail, suffix **.../MFC/EF**



Straight System Screen

	Group 1	Group 2	Group 3	Group 4	Group 5	Group 6	Group 7	Acrylic	MFC
ESS18... - 1773w x 27d x 375h	£419	£431	£443	£455	£467	£479	£491	£419	£382
ESS16... - 1573w x 27d x 375h	£385	£397	£409	£421	£433	£445	£457	£385	£351
ESS14... - 1373w x 27d x 375h	£357	£369	£381	£393	£405	£417	£429	£357	£324
ESS12... - 1173w x 27d x 375h	£325	£337	£349	£361	£373	£385	£397	£325	£295

Straight System Screen with Management Rail

ESS18M... - 1773w x 27d x 375h	£559	£571	£583	£595	£607	£619	£631	£559	£507
ESS16M... - 1573w x 27d x 375h	£516	£528	£540	£552	£564	£576	£588	£516	£469
ESS14M... - 1373w x 27d x 375h	£454	£466	£478	£490	£502	£514	£526	£454	£431
ESS12M... - 1173w x 27d x 375h	£422	£434	£446	£458	£470	£482	£494	£422	£382

Linnea Elevate Desk Mounted Acoustic Screen for Single Desks

- Straight dividing screens faced with 6mm polyester fibre insulation board.
- Screen is bracketed to the outer edge of the desk top.
- Link post not required.
- Available as Hygiene Protection Screens and add-ons (see page 52-53).

- Class B certified in accordance with International Standards:

- ISO 354:2003
- ISO 11654:1997
- ISO 9613-1:1993

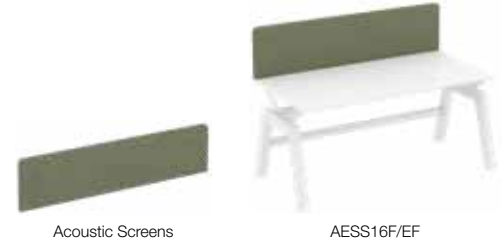

Straight Acoustic Screen

	Group 1	Group 2	Group 3	Group 4	Group 5	Group 6	Group 7
AESS18F/EF - 1762w x 38d x 375h	£526	£538	£550	£562	£574	£586	£598
AESS16F/EF - 1562w x 38d x 375h	£482	£494	£506	£518	£530	£542	£554
AESS14F/EF - 1362w x 38d x 375h	£449	£461	£473	£485	£497	£509	£521
AESS12F/EF - 1162w x 38d x 375h	£409	£421	£433	£445	£457	£469	£481

Linnea Elevate Acrylic Hygiene Protection Screens for Double Benches

Lead Time: Standard (All products are manufactured to order and when 'Standard Lead Time' is quoted (7 – 10 days), this may vary dependant on volume ordered, factory capacity and distribution requirements at the time of ordering. For more information please contact your Dealer Business Manager or the Customer Services Team for clarification.)

Acrylic: Clear

Metalwork: Fixing Brackets supplied in Silver RAL 9006 (Standard) - Optional Black Graphite RAL 9004 and White RAL 9003



Acrylic Illustrated in Blue



LESS16/HPS
Acrylic Illustrated in Blue



Linnea Elevate Desk Mounted Acrylic Hygiene Protection Screen for Double Benches with Screens

- Rectangular acrylic dividing screens supplied with brackets.
- Screen is bracketed to the existing screen frame.
- Brackets supplied in Silver RAL 9006 as standard.
- Screens compatible with Non-Elite Desk Mounted Screens available.

Addition for 27mm Linnea Elevate Desk Mounted System Screen

	Price
LESS18/HPS - 1773w x 5d x 400h	£212
LESS16/HPS - 1573w x 5d x 400h	£199
LESS14/HPS - 1373w x 5d x 400h	£189
LESS12/HPS - 1173w x 5d x 400h	£171

Addition for 38mm Linnea Elevate Desk Mounted Acoustic Screen

ALESS18F/HPS - 1762w x 5d x 400h	£212
ALESS16F/HPS - 1562w x 5d x 400h	£199
ALESS14F/HPS - 1362w x 5d x 400h	£189
ALESS12F/HPS - 1162w x 5d x 400h	£171



ELEHPSMR8
Acrylic Illustrated in Blue



Linnea Elevate Desk Mounted Mid Return Acrylic Hygiene Protection Screen for Double Benches

- Rectangular acrylic dividing screens supplied with freestanding feet.
- Freestanding screen supplied with self adhesive pads.
- Freestanding feet supplied in Silver RAL 9006 as standard.

Linnea Elevate Desk Mounted Mid Return Screen

ELEHPSMR8 - 780w x 5d x 700h	£248
-------------------------------------	------



EHPSE8
Acrylic Illustrated in Blue



Linnea Elevate Desk Mounted End Return Acrylic Hygiene Protection Screen for Double Benches

- Rectangular acrylic dividing screens supplied with fixing brackets.
- Screen is clamped to the desktop.
- Brackets supplied in Silver RAL 9006 as standard.

Linnea Elevate Desk Mounted End Return Screen

EHPSE8 - 780w x 5d x 700h	£248
----------------------------------	------

Linnea Elevate Acrylic Hygiene Protection Screens for Single Desks

Lead Time: Standard (All products are manufactured to order and when 'Standard Lead Time' is quoted (7 – 10 days), this may vary dependant on volume ordered, factory capacity and distribution requirements at the time of ordering. For more information please contact your Dealer Business Manager or the Customer Services Team for clarification.)

Acrylic: Clear

Metalwork: Fixing Brackets supplied in Silver RAL 9006 (Standard) - Optional Black Graphite RAL 9004 and White RAL 9003



EHPS16
Acrylic Illustrated in Blue



Linnea Elevate Desk Mounted Acrylic Hygiene Protection Screen for Single Desks

- Rectangular acrylic dividing screens supplied with fixing brackets.
- Screen is clamped to the desktop.
- Brackets supplied in Silver RAL 9006 as standard.
- For a central opening of 400w x 60h, suffix .../O.

Linnea Elevate Desk Mounted Screen

	Price
EHPS18 - 1773w x 5d x 700h	£342
EHPS16 - 1573w x 5d x 700h	£316
EHPS14 - 1373w x 5d x 700h	£294
EHPS12 - 1173w x 5d x 700h	£265



ESS16/HPS
Acrylic Illustrated in Blue



Linnea Elevate Desk Mounted Acrylic Hygiene Protection Screen for Single Desks with Screens

- Rectangular acrylic dividing screens supplied with brackets.
- Screen is bracketed to the existing screen frame.
- Brackets supplied in Silver RAL 9006 as standard.
- Screens compatible with Non-Elite Desk Mounted Screens available.

Addition for 27mm Linnea Elevate Desk Mounted System Screen

	Price
ESS18/HPS - 1773w x 5d x 325h	£212
ESS16/HPS - 1573w x 5d x 325h	£199
ESS14/HPS - 1373w x 5d x 325h	£189
ESS12/HPS - 1173w x 5d x 325h	£171

Addition for 38mm Linnea Elevate Desk Mounted Acoustic Screen

AESS18F/HPS - 1773w x 5d x 325h	£212
AESS16F/HPS - 1573w x 5d x 325h	£199
AESS14F/HPS - 1373w x 5d x 325h	£189
AESS12F/HPS - 1173w x 5d x 325h	£171



ELEHPSMR8
Acrylic Illustrated in Blue



Linnea Elevate Desk Mounted Mid Return Acrylic Hygiene Protection Screen for Single Desks

- Rectangular acrylic dividing screens supplied with freestanding feet.
- Freestanding screen supplied with self adhesive pads.
- Freestanding feet supplied in Silver RAL 9006 as standard.

Linnea Elevate Desk Mounted Mid Return Screen

	Price
ELEHPSMR8 - 780w x 5d x 700h	£248
ELEHPSMR7 - 680w x 5d x 700h	£235
ELEHPSMR6 - 580w x 5d x 700h	£222



EHPSE8
Acrylic Illustrated in Blue



Linnea Elevate Desk Mounted End Return Acrylic Hygiene Protection Screen for Single Desks

- Rectangular acrylic dividing screens supplied with fixing brackets.
- Screen is clamped to the desktop.
- Brackets supplied in Silver RAL 9006 as standard.

Linnea Elevate Desk Mounted End Return Screen

EHPSE8 - 780w x 5d x 700h	Price £248
----------------------------------	----------------------

LUX Fixed Height Workstations and Benches

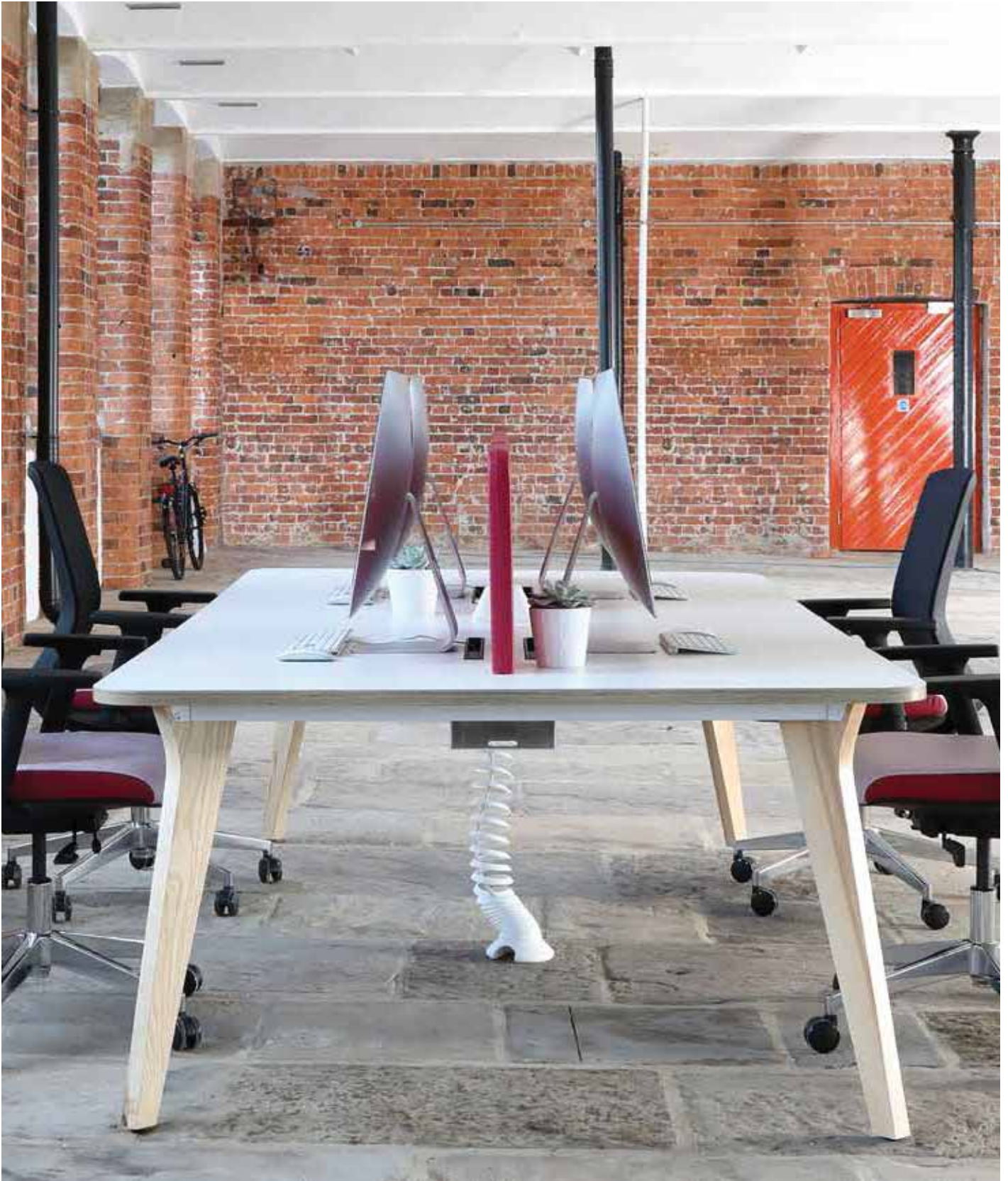

Central to its design is the creation of an elegant, contemporary bench with tapered wooden legs and a cleverly engineered steel sub frame. Lux provides the perfect solution for a less corporate, modern office, dining, conference or breakout area. The range is available in a number of sizes, shapes and wood finishes providing a flexible product for many working spaces.

Lead Time: 2 Weeks

Wood: Available in MFC (Ash, Autumn Cherry, Beech, Chester Oak, English Walnut, Grey, Grey Nebraska Oak, Laurentii Wenge, Natural Nebraska Oak and White)
 Top Panel Edge Detail available on 25mm White MFC (Wenge and Black - Add £32 Retail Per Top) (Plywood - Add £42 Retail Per Top)
 Available in Veneer (Oak and Walnut) on a 3 Week Lead Time

Metalwork: Available in Silver RAL 9006 (Standard), Black Graphite RAL 9004 and White RAL 9003

Finishes: Available in the finishes detailed below

How to Specify Lux Benches

Lux double benches can be combined to allow for any number of positions required in a single run. Simply specify from the below text for what is required.

A - 1 Piece Top

To accommodate 2-4 positions specify 1x 'Lux Double Bench' shown below only.

B - 2 Piece Top

To accommodate 4-8 positions specify 1x 'Lux Combined Double Bench' on page 56 only.

C - 3+ Piece Top

To accommodate 6-12+ positions a combination of Lux products will be required.

For the initial 4-8 positions specify 1x 'Lux Combined Double Bench' on page 56.

For subsequent positions in 2-4 increments, specify 'Lux Combined Double Bench with Shared Leg' on page 56.

To add radius corners to the run of benches, simply suffix .../RC to either the 'Lux Double Bench' or the 'Lux Combined Double Bench'. The radius corners do not apply to the 'Combined Double Bench with Shared Leg' as they will always be used in the middle of a run. See page 57.

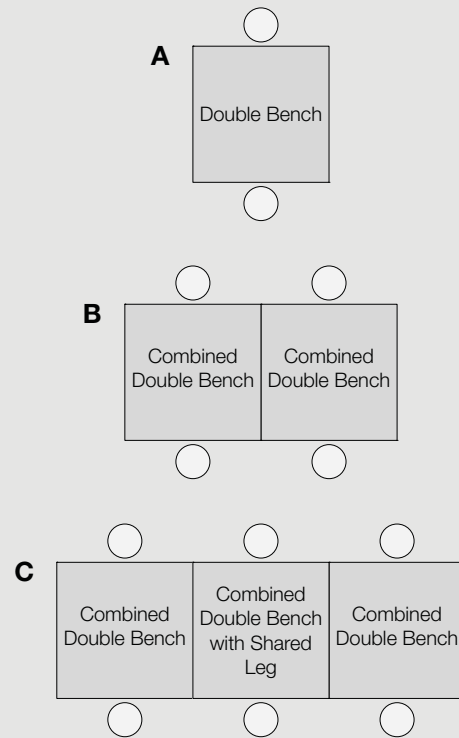

LUXB16/16/ASL

Lux Double Bench

- 2 week lead time. • For how to specify, see above. • 25mm top panel.
- Tapered legs with adjustable levelling feet and steel sub-frame.
- Complete with horizontal cable trays.
- Available with radiused corners, suffix .../RC (see page 57).

						MFC	Veneer (3 Week Lead Time)
LUXB28/16...	- 1x Section	- 4x Slots	- 2800w x 1600d x 740h	_____		£2,646	-
LUXB26/16...	- 1x Section	- 4x Slots	- 2600w x 1600d x 740h	_____		£2,562	£3,713
LUXB24/16...	- 1x Section	- 4x Slots	- 2400w x 1600d x 740h	_____		£2,485	£3,603
LUXB22/16...	- 1x Section	- 4x Slots	- 2200w x 1600d x 740h	_____		£2,336	£3,386
LUXB20/16...	- 1x Section	- 4x Slots	- 2000w x 1600d x 740h	_____		£2,188	£3,176
LUXB18/16...	- 1x Section	- 2x Slots	- 1800w x 1600d x 740h	_____		£2,044	£2,962
LUXB16/16...	- 1x Section	- 2x Slots	- 1600w x 1600d x 740h	_____		£1,894	£2,746
LUXB14/16...	- 1x Section	- 2x Slots	- 1400w x 1600d x 740h	_____		£1,750	£2,531
LUXB28/14...	- 1x Section	- 4x Slots	- 2800w x 1400d x 740h	_____		£2,567	-
LUXB26/14...	- 1x Section	- 4x Slots	- 2600w x 1400d x 740h	_____		£2,495	£3,616
LUXB24/14...	- 1x Section	- 4x Slots	- 2400w x 1400d x 740h	_____		£2,419	£3,508
LUXB22/14...	- 1x Section	- 4x Slots	- 2200w x 1400d x 740h	_____		£2,272	£3,290
LUXB20/14...	- 1x Section	- 4x Slots	- 2000w x 1400d x 740h	_____		£2,123	£3,079
LUXB18/14...	- 1x Section	- 2x Slots	- 1800w x 1400d x 740h	_____		£1,974	£2,864
LUXB16/14...	- 1x Section	- 2x Slots	- 1600w x 1400d x 740h	_____		£1,829	£2,651
LUXB14/14...	- 1x Section	- 2x Slots	- 1400w x 1400d x 740h	_____		£1,681	£2,437
LUXB28/12...	- 1x Section	- 4x Slots	- 2800w x 1200d x 740h	_____		£2,502	-
LUXB26/12...	- 1x Section	- 4x Slots	- 2600w x 1200d x 740h	_____		£2,426	£3,519
LUXB24/12...	- 1x Section	- 4x Slots	- 2400w x 1200d x 740h	_____		£2,354	£3,413
LUXB22/12...	- 1x Section	- 4x Slots	- 2200w x 1200d x 740h	_____		£2,205	£3,198
LUXB20/12...	- 1x Section	- 4x Slots	- 2000w x 1200d x 740h	_____		£2,059	£2,985
LUXB18/12...	- 1x Section	- 2x Slots	- 1800w x 1200d x 740h	_____		£1,909	£2,768
LUXB16/12...	- 1x Section	- 2x Slots	- 1600w x 1200d x 740h	_____		£1,763	£2,557
LUXB14/12...	- 1x Section	- 2x Slots	- 1400w x 1200d x 740h	_____		£1,617	£2,343

- Add £0 for Ash (.../ASL)
- Add £54 for Stained Walnut (.../WAL)
- Add £62 for Stained Espresso (.../ESL), Wenge (.../WEL) and Black (.../BKL)
- Add £78 for White (.../WHL)

Lead Time: 2 Weeks

Wood: Available in MFC (Ash, Autumn Cherry, Beech, Chester Oak, English Walnut, Grey, Grey Nebraska Oak, Laurentii Wenge, Natural Nebraska Oak and White)
Top Panel Edge Detail available on 25mm White MFC (Wenge and Black - Add £32 Retail Per Top) (Plywood - Add £42 Retail Per Top)
Available in Veneer (Oak and Walnut) on a 3 Week Lead Time

Metalwork: Available in Silver RAL 9006 (Standard), Black Graphite RAL 9004 and White RAL 9003

Finishes: Available in the finishes detailed below



LUXCB32/16/ASL

Lux Combined Double Bench

- 2 week lead time. • For how to specify, see page 55. • 2x 25mm top panels.
- Tapered legs with adjustable levelling feet and steel sub-frame. • Complete with horizontal cable trays.
- Available with radiused corners, suffix .../RC (see page 57).

							MFC	Veneer (3 Week Lead Time)
LUXCB56/16...	- 2x Sections	- 8x Slots	- 5600w x 1600d x 740h	-----			£5,160	-
LUXCB52/16...	- 2x Sections	- 8x Slots	- 5200w x 1600d x 740h	-----			£5,004	£7,258
LUXCB48/16...	- 2x Sections	- 8x Slots	- 4800w x 1600d x 740h	-----			£4,853	£7,035
LUXCB44/16...	- 2x Sections	- 8x Slots	- 4400w x 1600d x 740h	-----			£4,556	£6,605
LUXCB40/16...	- 2x Sections	- 8x Slots	- 4000w x 1600d x 740h	-----			£4,259	£6,179
LUXCB36/16...	- 2x Sections	- 4x Slots	- 3600w x 1600d x 740h	-----			£3,967	£5,752
LUXCB32/16...	- 2x Sections	- 4x Slots	- 3200w x 1600d x 740h	-----			£3,670	£5,322
LUXCB28/16...	- 2x Sections	- 4x Slots	- 2800w x 1600d x 740h	-----			£3,376	£4,893
LUXCB56/14...	- 2x Sections	- 8x Slots	- 5600w x 1400d x 740h	-----			£5,016	-
LUXCB52/14...	- 2x Sections	- 8x Slots	- 5200w x 1400d x 740h	-----			£4,871	£7,063
LUXCB48/14...	- 2x Sections	- 8x Slots	- 4800w x 1400d x 740h	-----			£4,720	£6,843
LUXCB44/14...	- 2x Sections	- 8x Slots	- 4400w x 1400d x 740h	-----			£4,423	£6,415
LUXCB40/14...	- 2x Sections	- 8x Slots	- 4000w x 1400d x 740h	-----			£4,131	£5,990
LUXCB36/14...	- 2x Sections	- 4x Slots	- 3600w x 1400d x 740h	-----			£3,834	£5,559
LUXCB32/14...	- 2x Sections	- 4x Slots	- 3200w x 1400d x 740h	-----			£3,539	£5,131
LUXCB28/14...	- 2x Sections	- 4x Slots	- 2800w x 1400d x 740h	-----			£3,246	£4,703
LUXCB56/12...	- 2x Sections	- 8x Slots	- 5600w x 1200d x 740h	-----			£4,883	-
LUXCB52/12...	- 2x Sections	- 8x Slots	- 5200w x 1200d x 740h	-----			£4,737	£6,870
LUXCB48/12...	- 2x Sections	- 8x Slots	- 4800w x 1200d x 740h	-----			£4,590	£6,654
LUXCB44/12...	- 2x Sections	- 8x Slots	- 4400w x 1200d x 740h	-----			£4,292	£6,224
LUXCB40/12...	- 2x Sections	- 8x Slots	- 4000w x 1200d x 740h	-----			£3,999	£5,800
LUXCB36/12...	- 2x Sections	- 4x Slots	- 3600w x 1200d x 740h	-----			£3,699	£5,366
LUXCB32/12...	- 2x Sections	- 4x Slots	- 3200w x 1200d x 740h	-----			£3,407	£4,943
LUXCB28/12...	- 2x Sections	- 4x Slots	- 2800w x 1200d x 740h	-----			£3,116	£4,513

- Add £0 for Ash (.../ASL)
- Add £81 for Stained Walnut (.../WAL)
- Add £93 for Stained Espresso (.../ESL), Wenge (.../WEL) and Black (.../BKL)
- Add £117 for White (.../WHL)



LUXCB16/16/INT/ASL

Lux Combined Double Bench with Shared Leg

- 2 week lead time. • For how to specify, see page 55. • 25mm top panel.
- Tapered legs with adjustable levelling feet and steel sub-frame.
- Complete with horizontal cable trays.

							MFC	Veneer (3 Week Lead Time)
LUXCB28/16/INT...	- 1x Section	- 4x Slots	- 2800w x 1600d x 740h	-----			£2,513	-
LUXCB26/16/INT...	- 1x Section	- 4x Slots	- 2600w x 1600d x 740h	-----			£2,444	£3,545
LUXCB24/16/INT...	- 1x Section	- 4x Slots	- 2400w x 1600d x 740h	-----			£2,366	£3,431
LUXCB22/16/INT...	- 1x Section	- 4x Slots	- 2200w x 1600d x 740h	-----			£2,218	£3,219
LUXCB20/16/INT...	- 1x Section	- 4x Slots	- 2000w x 1600d x 740h	-----			£2,072	£3,003
LUXCB18/16/INT...	- 1x Section	- 2x Slots	- 1800w x 1600d x 740h	-----			£1,926	£2,790
LUXCB16/16/INT...	- 1x Section	- 2x Slots	- 1600w x 1600d x 740h	-----			£1,777	£2,576
LUXCB14/16/INT...	- 1x Section	- 2x Slots	- 1400w x 1600d x 740h	-----			£1,629	£2,361
LUXCB28/14/INT...	- 1x Section	- 4x Slots	- 2800w x 1400d x 740h	-----			£2,450	-
LUXCB26/14/INT...	- 1x Section	- 4x Slots	- 2600w x 1400d x 740h	-----			£2,377	£3,446
LUXCB24/14/INT...	- 1x Section	- 4x Slots	- 2400w x 1400d x 740h	-----			£2,301	£3,337
LUXCB22/14/INT...	- 1x Section	- 4x Slots	- 2200w x 1400d x 740h	-----			£2,154	£3,124
LUXCB20/14/INT...	- 1x Section	- 4x Slots	- 2000w x 1400d x 740h	-----			£2,006	£2,909
LUXCB18/14/INT...	- 1x Section	- 2x Slots	- 1800w x 1400d x 740h	-----			£1,856	£2,693
LUXCB16/14/INT...	- 1x Section	- 2x Slots	- 1600w x 1400d x 740h	-----			£1,710	£2,480
LUXCB14/14/INT...	- 1x Section	- 2x Slots	- 1400w x 1400d x 740h	-----			£1,562	£2,261
LUXCB28/12/INT...	- 1x Section	- 4x Slots	- 2800w x 1200d x 740h	-----			£2,383	-
LUXCB26/12/INT...	- 1x Section	- 4x Slots	- 2600w x 1200d x 740h	-----			£2,308	£3,349
LUXCB24/12/INT...	- 1x Section	- 4x Slots	- 2400w x 1200d x 740h	-----			£2,236	£3,243
LUXCB22/12/INT...	- 1x Section	- 4x Slots	- 2200w x 1200d x 740h	-----			£2,087	£3,027
LUXCB20/12/INT...	- 1x Section	- 4x Slots	- 2000w x 1200d x 740h	-----			£1,941	£2,813
LUXCB18/12/INT...	- 1x Section	- 2x Slots	- 1800w x 1200d x 740h	-----			£1,791	£2,597
LUXCB16/12/INT...	- 1x Section	- 2x Slots	- 1600w x 1200d x 740h	-----			£1,645	£2,385
LUXCB14/12/INT...	- 1x Section	- 2x Slots	- 1400w x 1200d x 740h	-----			£1,498	£2,172

- Add £0 for Ash (.../ASL)
- Add £27 for Stained Walnut (.../WAL)
- Add £31 for Stained Espresso (.../ESL), Wenge (.../WEL) and Black (.../BKL)
- Add £39 for White (.../WHL)

Lead Time: 2 Weeks

Wood: Available in MFC (Ash, Autumn Cherry, Beech, Chester Oak, English Walnut, Grey, Grey Nebraska Oak, Laurentii Wenge, Natural Nebraska Oak and White)
Top Panel Edge Detail available on 25mm White MFC (Wenge and Black - Add £32 Retail Per Top) (Plywood - Add £42 Retail Per Top)
Available in Veneer (Oak and Walnut) on a 3 Week Lead Time

Metalwork: Available in Silver RAL 9006 (Standard), Black Graphite RAL 9004 and White RAL 9003

Finishes: Available in the finishes detailed below



LUXR16/8/ASL

Lux Rectangular Desk

- 2 week lead time.
- 25mm top panel with 2x cable ports.
- Tapered legs with adjustable levelling feet and steel sub-frame.

	MFC	Veneer (3 Week Lead Time)
LUXR20/10... - 1x Section - 2000w x 1000d x 740h	£1,776	£2,130
LUXR18/10... - 1x Section - 1800w x 1000d x 740h	£1,628	£1,953
LUXR16/10... - 1x Section - 1600w x 1000d x 740h	£1,482	£1,778
LUXR14/10... - 1x Section - 1400w x 1000d x 740h	£1,418	£1,701
LUXR12/10... - 1x Section - 1200w x 1000d x 740h	£1,350	£1,621
LUXR10/10... - 1x Section - 1000w x 1000d x 740h	£1,284	£1,541
LUXR20/8... - 1x Section - 2000w x 800d x 740h	£1,710	£2,053
LUXR18/8... - 1x Section - 1800w x 800d x 740h	£1,562	£1,875
LUXR16/8... - 1x Section - 1600w x 800d x 740h	£1,418	£1,700
LUXR14/8... - 1x Section - 1400w x 800d x 740h	£1,353	£1,623
LUXR12/8... - 1x Section - 1200w x 800d x 740h	£1,286	£1,543
LUXR10/8... - 1x Section - 1000w x 800d x 740h	£1,219	£1,464
LUXR20/6... - 1x Section - 2000w x 600d x 740h	£1,646	£1,974
LUXR18/6... - 1x Section - 1800w x 600d x 740h	£1,499	£1,797
LUXR16/6... - 1x Section - 1600w x 600d x 740h	£1,353	£1,622
LUXR14/6... - 1x Section - 1400w x 600d x 740h	£1,288	£1,547
LUXR12/6... - 1x Section - 1200w x 600d x 740h	£1,221	£1,466
LUXR10/6... - 1x Section - 1000w x 600d x 740h	£1,155	£1,386

- Add £0 for Ash (.../ASL)
- Add £54 for Stained Walnut (.../WAL)
- Add £62 for Stained Espresso (.../ESL), Wenge (.../WEL) and Black (.../BKL)
- Add £78 for White (.../WHL)



.../RC

Lux Optional Radiused Corners

- Adds a radius to 4 corners of specific Lux workstations.
- Suffix .../RC to the end of relevant Lux codes.

	Price
.../RC - Radiused Corners	£64

Lead Time: 2 Weeks

Wood: Available in MFC (Ash, Autumn Cherry, Beech, Chester Oak, English Walnut, Grey, Grey Nebraska Oak, Laurentii Wenge, Natural Nebraska Oak and White)
 Top Panel Edge Detail available on 25mm White MFC (Wenge and Black - Add £32 Retail Per Top) (Plywood - Add £42 Retail Per Top)
 Available in Veneer (Oak and Walnut) on a 3 Week Lead Time

Metalwork: Available in Silver RAL 9006 (Standard), Black Graphite RAL 9004 and White RAL 9003

Finishes: Available in the finishes detailed below



LUXCPU/W and LUXCPU

Lux CPU Holder

- Includes Lux mounting kit.
- Adjustable CPU holder for PC towers.
- Rotates a full 360 degrees for complete access to cables and ports.

Price

LUXCPU - Black Trim	_____	£192
LUXCPU/W - White Trim	_____	£192



2LM2BS

M2 Monitor Arm

- Post mounted monitor arm with spring assisted tension.

Price

2LM2BS - Silver Bolt through Desk Fixing	_____	£304
2LM2BW - White Bolt through Desk Fixing	_____	£304

• Spring Assisted Tension Height Adjustment



SCR/S - SCR/B - SCR/W

Slinky Cable Riser

- Suitable for all desking ranges.

Price

SCR/S - Silver	_____	£59
SCR/B - Black	_____	£59
SCR/W - White	_____	£59



LUXOCT2800/ASL

Lux Octagonal Conference Table

- 2 week lead time.
- 25mm top panel.
- Tapered legs with adjustable levelling feet and steel sub-frame.

MFC **Veneer
(3 Week
Lead Time)**

LUXOCT2800... - 2800w x 1200d x 740h	_____	£2,308	-
• 1x 2800mm Section	• Seating up to 10 People		
LUXOCT2600... - 2600w x 1200d x 740h	_____	£2,220	£2,663
• 1x 2600mm Section	• Seating up to 8 People		
LUXOCT2400... - 2400w x 1000d x 740h	_____	£2,151	£2,579
• 1x 2400mm Section	• Seating up to 8 People		

- Add £0 for Ash (.../ASL)
- Add £54 for Stained Walnut (.../WAL)
- Add £62 for Stained Espresso (.../ESL), Wenge (.../WEL) and Black (.../BKL)
- Add £78 for White (.../WHL)

Lead Time: 2 Weeks

Wood: Available in MFC (Ash, Autumn Cherry, Beech, Chester Oak, English Walnut, Grey, Grey Nebraska Oak, Laurentii Wenge, Natural Nebraska Oak and White)
Top Panel Edge Detail available on 25mm White MFC (Wenge and Black - Add £32 Retail Per Top) (Plywood - Add £42 Retail Per Top)
Available in Veneer (Oak and Walnut) on a 3 Week Lead Time

Metalwork: Available in Silver RAL 9006 (Standard), Black Graphite RAL 9004 and White RAL 9003

Finishes: Available in the finishes detailed below



LUXMT32/12/ASL

Lux Rectangular Meeting Table

- 2 week lead time.
- 2x 25mm top panels.
- Tapered legs with adjustable levelling feet and steel sub-frame.
- Available with radiused corners, suffix **.../RC** (see page 57).

			MFC	Veneer (3 Week Lead Time)
LUXMT48/14...	- 2x Sections	- 4800w x 1400d x 740h	£3,725	£4,470
LUXMT44/14...	- 2x Sections	- 4400w x 1400d x 740h	£3,596	£4,312
LUXMT40/14...	- 2x Sections	- 4000w x 1400d x 740h	£3,464	£4,158
LUXMT36/14...	- 2x Sections	- 3600w x 1400d x 740h	£3,334	£4,000
LUXMT32/14...	- 2x Sections	- 3200w x 1400d x 740h	£3,202	£3,844
LUXMT30/14...	- 2x Sections	- 3000w x 1400d x 740h	£3,139	£3,766
LUXMT48/12...	- 2x Sections	- 4800w x 1200d x 740h	£3,582	£4,298
LUXMT44/12...	- 2x Sections	- 4400w x 1200d x 740h	£3,451	£4,141
LUXMT40/12...	- 2x Sections	- 4000w x 1200d x 740h	£3,320	£3,986
LUXMT36/12...	- 2x Sections	- 3600w x 1200d x 740h	£3,191	£3,831
LUXMT32/12...	- 2x Sections	- 3200w x 1200d x 740h	£3,060	£3,672
LUXMT30/12...	- 2x Sections	- 3000w x 1200d x 740h	£2,981	£3,594
LUXMT48/10...	- 2x Sections	- 4800w x 1000d x 740h	£3,439	£4,126
LUXMT44/10...	- 2x Sections	- 4400w x 1000d x 740h	£3,308	£3,969
LUXMT40/10...	- 2x Sections	- 4000w x 1000d x 740h	£3,178	£3,814
LUXMT36/10...	- 2x Sections	- 3600w x 1000d x 740h	£3,046	£3,656
LUXMT32/10...	- 2x Sections	- 3200w x 1000d x 740h	£2,918	£3,500
LUXMT30/10...	- 2x Sections	- 3000w x 1000d x 740h	£2,852	£3,422

- Add £0 for Ash (.../ASL)
- Add £81 for Stained Walnut (.../WAL)
- Add £93 for Stained Espresso (.../ESL), Wenge (.../WEL) and Black (.../BKL)
- Add £117 for White (.../WHL)



Lead Time: 2 Weeks

Wood: Available in MFC (Ash, Autumn Cherry, Beech, Chester Oak, English Walnut, Grey, Grey Nebraska Oak, Laurentii Wenge, Natural Nebraska Oak and White)
Top Panel Edge Detail available on 25mm White MFC (Wenge and Black - Add £32 Retail Per Top) (Plywood - Add £42 Retail Per Top)
Available in Veneer (Oak and Walnut) on a 3 Week Lead Time

Metalwork: Available in Silver RAL 9006 (Standard), Black Graphite RAL 9004 and White RAL 9003

Finishes: Available in the finishes detailed below



LUXMT16/12/ASL

Lux Rectangular Meeting Table

- 2 week lead time. • 25mm top panel.
- Tapered legs with adjustable levelling feet and steel sub-frame.
- Available with radiused corners, suffix .../RC (see page 57).

	MFC	Veneer (3 Week Lead Time)
LUXMT28/14... - 1x Section - 2800w x 1400d x 740h	£2,344	-
LUXMT26/14... - 1x Section - 2600w x 1400d x 740h	£2,272	£2,725
LUXMT24/14... - 1x Section - 2400w x 1400d x 740h	£2,197	£2,636
LUXMT22/14... - 1x Section - 2200w x 1400d x 740h	£2,051	£2,459
LUXMT20/14... - 1x Section - 2000w x 1400d x 740h	£1,906	£2,287
LUXMT18/14... - 1x Section - 1800w x 1400d x 740h	£1,757	£2,110
LUXMT16/14... - 1x Section - 1600w x 1400d x 740h	£1,611	£1,933
LUXMT28/12... - 1x Section - 2800w x 1200d x 740h	£2,278	-
LUXMT26/12... - 1x Section - 2600w x 1200d x 740h	£2,205	£2,647
LUXMT24/12... - 1x Section - 2400w x 1200d x 740h	£2,134	£2,561
LUXMT22/12... - 1x Section - 2200w x 1200d x 740h	£1,988	£2,383
LUXMT20/12... - 1x Section - 2000w x 1200d x 740h	£1,839	£2,209
LUXMT18/12... - 1x Section - 1800w x 1200d x 740h	£1,692	£2,030
LUXMT16/12... - 1x Section - 1600w x 1200d x 740h	£1,548	£1,855
LUXMT14/12... - 1x Section - 1400w x 1200d x 740h	£1,482	£1,778
LUXMT28/10... - 1x Section - 2800w x 1000d x 740h	£2,213	-
LUXMT26/10... - 1x Section - 2600w x 1000d x 740h	£2,139	£2,569
LUXMT24/10... - 1x Section - 2400w x 1000d x 740h	£2,067	£2,480
LUXMT22/10... - 1x Section - 2200w x 1000d x 740h	£1,918	£2,302
LUXMT20/10... - 1x Section - 2000w x 1000d x 740h	£1,776	£2,130
LUXMT18/10... - 1x Section - 1800w x 1000d x 740h	£1,628	£1,954
LUXMT16/10... - 1x Section - 1600w x 1000d x 740h	£1,482	£1,778
LUXMT14/10... - 1x Section - 1400w x 1000d x 740h	£1,418	£1,701
LUXMT12/10... - 1x Section - 1200w x 1000d x 740h	£1,350	£1,621

- Add £0 for Ash (.../ASL)
- Add £54 for Stained Walnut (.../WAL)
- Add £62 for Stained Espresso (.../ESL), Wenge (.../WEL) and Black (.../BKL)
- Add £78 for White (.../WHL)



LUXMT16/16/ASL

Lux Square Meeting Table

- 2 week lead time. • 25mm top panel.
- Tapered legs with adjustable levelling feet and steel sub-frame.
- Available with radiused corners, suffix .../RC (see page 57).

	MFC	Veneer (3 Week Lead Time)
LUXMT20/20... - 2000w x 2000d x 740h	£2,014	£2,415
LUXMT18/18... - 1800w x 1800d x 740h	£1,868	£2,240
LUXMT16/16... - 1600w x 1600d x 740h	£1,719	£2,063
LUXMT14/14... - 1400w x 1400d x 740h	£1,572	£1,887
LUXMT12/12... - 1200w x 1200d x 740h	£1,426	£1,710
LUXMT10/10... - 1000w x 1000d x 740h	£1,279	£1,537

- Add £0 for Ash (.../ASL)
- Add £54 for Stained Walnut (.../WAL)
- Add £62 for Stained Espresso (.../ESL), Wenge (.../WEL) and Black (.../BKL)
- Add £78 for White (.../WHL)



LUXMT/CIR16/ASL

Lux Circular Meeting Table

- 2 week lead time. • 25mm top panel.
- Tapered legs with adjustable levelling feet and steel sub-frame.

	MFC	Veneer (3 Week Lead Time)
LUXMT/CIR20... - 2000w (dia) x 740h	£2,124	£2,531
LUXMT/CIR18... - 1800w (dia) x 740h	£1,963	£2,355
LUXMT/CIR16... - 1600w (dia) x 740h	£1,800	£2,161
LUXMT/CIR14... - 1400w (dia) x 740h	£1,675	£2,010
LUXMT/CIR12... - 1200w (dia) x 740h	£1,426	£1,710
LUXMT/CIR10... - 1000w (dia) x 740h	£1,311	£1,572

- Add £0 for Ash (.../ASL)
- Add £54 for Stained Walnut (.../WAL)
- Add £62 for Stained Espresso (.../ESL), Wenge (.../WEL) and Black (.../BKL)
- Add £78 for White (.../WHL)

Lead Time: 2 Weeks

Wood: Available in MFC (Ash, Autumn Cherry, Beech, Chester Oak, English Walnut, Grey, Grey Nebraska Oak, Laurentii Wenge, Natural Nebraska Oak and White)
Top Panel Edge Detail available on 25mm White MFC (Wenge and Black - Add £32 Retail Per Top) (Plywood - Add £42 Retail Per Top)
Available in Veneer (Oak and Walnut) on a 3 Week Lead Time

Metalwork: Available in Silver RAL 9006 (Standard), Black Graphite RAL 9004 and White RAL 9003

Finishes: Available in the finishes detailed below



LUXHB32/12/ASL

Lux High Bench Table

- 2 week lead time. • 2x 25mm top panels.
- Tapered legs with adjustable levelling feet and steel sub-frame.
- Available with radiused corners, suffix **.../RC** (see page 57).

			MFC	Veneer (3 Week Lead Time)
LUXHB40/12...	- 2x Sections	- 4000w x 1200d x 1050h	£3,999	£4,662
LUXHB36/12...	- 2x Sections	- 3600w x 1200d x 1050h	£3,870	£4,507
LUXHB32/12...	- 2x Sections	- 3200w x 1200d x 1050h	£3,738	£4,349
LUXHB30/12...	- 2x Sections	- 3000w x 1200d x 1050h	£3,658	£4,271
LUXHB40/10...	- 2x Sections	- 4000w x 1000d x 1050h	£3,854	£4,491
LUXHB36/10...	- 2x Sections	- 3600w x 1000d x 1050h	£3,725	£4,333
LUXHB32/10...	- 2x Sections	- 3200w x 1000d x 1050h	£3,597	£4,177
LUXHB30/10...	- 2x Sections	- 3000w x 1000d x 1050h	£3,529	£4,099

- Add £0 for Ash (**.../ASL**)
- Add £111 for Stained Walnut (**.../WAL**)
- Add £129 for Stained Espresso (**.../ESL**), Wenge (**.../WEL**) and Black (**.../BKL**)
- Add £174 for White (**.../WHL**)



LUXHB16/12/ASL

Lux High Bench Table

- 2 week lead time. • 25mm top panel.
- Tapered legs with adjustable levelling feet and steel sub-frame.
- Available with radiused corners, suffix **.../RC** (see page 57).

			MFC	Veneer (3 Week Lead Time)
LUXHB24/12...	- 1x Section	- 2400w x 1200d x 1050h	£2,585	£3,013
LUXHB22/12...	- 1x Section	- 2200w x 1200d x 1050h	£2,439	£2,833
LUXHB20/12...	- 1x Section	- 2000w x 1200d x 1050h	£2,291	£2,660
LUXHB18/12...	- 1x Section	- 1800w x 1200d x 1050h	£2,142	£2,483
LUXHB16/12...	- 1x Section	- 1600w x 1200d x 1050h	£1,999	£2,307
LUXHB14/12...	- 1x Section	- 1400w x 1200d x 1050h	£1,933	£2,229
LUXHB24/10...	- 1x Section	- 2400w x 1000d x 1050h	£2,521	£2,933
LUXHB22/10...	- 1x Section	- 2200w x 1000d x 1050h	£2,371	£2,754
LUXHB20/10...	- 1x Section	- 2000w x 1000d x 1050h	£2,227	£2,582
LUXHB18/10...	- 1x Section	- 1800w x 1000d x 1050h	£2,080	£2,405
LUXHB16/10...	- 1x Section	- 1600w x 1000d x 1050h	£1,933	£2,229
LUXHB14/10...	- 1x Section	- 1400w x 1000d x 1050h	£1,870	£2,153

- Add £0 for Ash (**.../ASL**)
- Add £74 for Stained Walnut (**.../WAL**)
- Add £86 for Stained Espresso (**.../ESL**), Wenge (**.../WEL**) and Black (**.../BKL**)
- Add £116 for White (**.../WHL**)



LUX Accessories

Lead Time: Standard (All products are manufactured to order and when 'Standard Lead Time' is quoted (7 – 10 days), this may vary dependant on volume ordered, factory capacity and distribution requirements at the time of ordering. For more information please contact your Dealer Business Manager or the Customer Services Team for clarification.)

Metalwork: Available in Silver RAL 9006 (Standard), Black Graphite RAL 9004 and White RAL 9003



LCTR16
Illustrated in red

Lux Cable Tray

- Compatible with all Lux tables.
- High capacity cable management system neatly conceals power, data and telecom cables through a hinged cable management tray. • Cable trays are 180mm deep and 80mm high.

			Metalwork
LCTO28	- For LUXOCT2800	- 1100w (2x)	£218
LCTO26	- For LUXOCT2600	- 1000w (2x)	£208
LCTO24	- For LUXOCT2400	- 900w (2x)	£190
LCTR48	- For 4800w Rectangular Tables	- 900w (4x)	£380
LCTR44	- For 4400w Rectangular Tables	- 800w (4x)	£356
LCTR40	- For 4000w Rectangular Tables	- 1500w (2x)	£250
LCTR36	- For 3600w Rectangular Tables	- 1300w (2x)	£234
LCTR32	- For 3200w Rectangular Tables	- 1100w (2x)	£218
LCTR30	- For 3000w Rectangular Tables	- 1000w (2x)	£208
LCTR28	- For 2800w Rectangular Tables	- 1100w (2x)	£218
LCTR26	- For 2600w Rectangular Tables	- 1000w (2x)	£208
LCTR24	- For 2400w Rectangular Tables	- 900w (2x)	£190
LCTR22	- For 2200w Rectangular Tables	- 800w (2x)	£178
LCTR20	- For 2000w Rectangular Tables	- 1500w	£125
LCTR18	- For 1800w Rectangular Tables	- 1300w	£117
LCTR16	- For 1600w Rectangular Tables	- 1100w	£109
LCTR14	- For 1400w Rectangular Tables	- 900w	£95
LCTR12	- For 1200w Rectangular Tables	- 700w	£81
LCTR10	- For 1000w Rectangular Tables	- 500w	£64
LCTS20	- For 2000w Square Meeting	- 1500w	£125
LCTS18	- For 1800w Square Meeting	- 1300w	£117
LCTS16	- For 1600w Square Meeting	- 1100w	£109
LCTS14	- For 1400w Square Meeting	- 900w	£95
LCTS12	- For 1200w Square Meeting	- 700w	£81
LCTS10	- For 1000w Square Meeting	- 500w	£64
LCTC18	- For 2000w and 1800w Circular Meeting	- 900w	£95
LCTC16	- For 1600w Circular Meeting	- 800w	£89
LCTC14	- For 1400w Circular Meeting	- 600w	£72
LCTC12	- For 1200w Circular Meeting	- 500w	£64

Lux Accessory Compatibility

- **BLACK** - Compatible
- **RED** - May not support larger modules

	Screens	Power and Data Modules								Monitor Arms					
	Lux Screens, page 63-64	Kaspa and Prime, page 309	Boardroom, Conus and Peak, page 310-312	Escalate, page 312	Wireless Charging Unit, page 313	Port Hole and Pix, page 314	Pluto and Inca, page 315	Flex and Capsule, page 316-317	Plaza and Boost, page 318	Wieland Socket Boxes, page 319	M2, page 320	Flex, page 320-322	Ascend, page 321-322	Ollin and Flo, page 321-322	M8, page 322
Workstations - Double Benches	●														
Workstations - Single Desks		●	●	●	●	●	●	●	●	●	●	●	●	●	
Meeting - Conference / Meeting (Excluding 1000w Circular)		●	●	●	●	●	●	●	●	●					
Meeting - 1000w Circular		●	●	●	●	●	●	●	●	●					
Meeting - Benches		●	●	●	●	●	●	●	●	●					

LUX Acoustic Screens for Double Benches

Lead Time: Standard (All products are manufactured to order and when 'Standard Lead Time' is quoted (7 – 10 days), this may vary dependant on volume ordered, factory capacity and distribution requirements at the time of ordering. For more information please contact your Dealer Business Manager or the Customer Services Team for clarification.)

Fabric: Fully upholstered with pinnable surface available in Groups 1-7

Lux Desk Mounted Acoustic Screen for Double Benches

- Straight dividing screens faced with 6mm polyester fibre insulation board.
- Screen is fixed to the underside of the desktop via 2x apertures.
- If a screen is removed following initial use, the 2x apertures will be exposed.
- Link post not required.
- Available as Hygiene Protection Screens and add-ons (see page 64).

• Class B certified in accordance with International Standards:

- ISO 354:2003
- ISO 11654:1997
- ISO 9613-1:1993



Acoustic Screens



AELUXSS1150F

Straight Acoustic Screen

	Group 1	Group 2	Group 3	Group 4	Group 5	Group 6	Group 7
AELUXSS1750F - 1750w x 38d x 375h	£526	£538	£550	£562	£574	£586	£598
AELUXSS1550F - 1550w x 38d x 375h	£482	£494	£506	£518	£530	£542	£554
AELUXSS1350F - 1350w x 38d x 375h	£449	£461	£473	£485	£497	£509	£521
AELUXSS1150F - 1150w x 38d x 375h	£409	£421	£433	£445	£457	£469	£481
AELUXSS950F - 950w x 38d x 375h	£386	£398	£410	£422	£434	£446	£458
AELUXSS850F - 850w x 38d x 375h	£374	£386	£398	£410	£422	£434	£446
AELUXSS750F - 750w x 38d x 375h	£360	£372	£384	£396	£408	£420	£432

Screen Compatibility

- Double Bench - Per 2800w Section
- Double Bench - Per 2600w Section
- Double Bench - Per 2400w Section
- Double Bench - Per 2200w Section
- Double Bench - Per 2000w Section
- Double Bench - Per 1800w Section
- Double Bench - Per 1600w Section
- Double Bench - Per 1400w Section

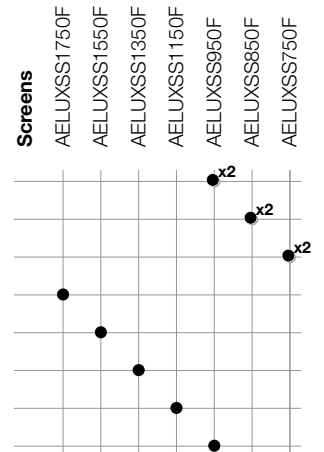

Lux Acrylic Hygiene Protection Screens for Double Benches

Lead Time: Standard (All products are manufactured to order and when 'Standard Lead Time' is quoted (7 – 10 days), this may vary dependant on volume ordered, factory capacity and distribution requirements at the time of ordering. For more information please contact your Dealer Business Manager or the Customer Services Team for clarification.)

Acrylic: Clear

Metalwork: Fixing Brackets supplied in Silver RAL 9006 (Standard) - Optional Black Graphite RAL 9004 and White RAL 9003



Acrylic Illustrated in Blue



AELUXSS1550F/HPS
Acrylic Illustrated in Blue



Lux Desk Mounted Acrylic Hygiene Protection Screen for Double Benches with Screens

- Rectangular acrylic dividing screens supplied with brackets.
- Screen is bracketed to the existing screen frame.
- Brackets supplied in Silver RAL 9006 as standard.
- Screens compatible with Non-Elite Desk Mounted Screens available.

Addition for 38mm Lux Desk Mounted Acoustic Screen

	Price
AELUXSS1750F/HPS - 1750w x 5d x 400h	£212
AELUXSS1550F/HPS - 1550w x 5d x 400h	£199
AELUXSS1350F/HPS - 1350w x 5d x 400h	£189
AELUXSS1150F/HPS - 1150w x 5d x 400h	£171
AELUXSS950F/HPS - 950w x 5d x 400h	£158
AELUXSS850F/HPS - 850w x 5d x 400h	£152
AELUXSS750F/HPS - 750w x 5d x 400h	£145



EHPSMR8
Acrylic Illustrated in Blue



Lux Desk Mounted Mid Return Acrylic Hygiene Protection Screen for Double Benches

- Rectangular acrylic dividing screens supplied with freestanding feet.
- Freestanding screen supplied with self adhesive pads.
- Freestanding feet supplied in Silver RAL 9006 as standard.

Lux Desk Mounted Mid Return Screen

	Price
EHPSMR8 - 780w x 5d x 700h	£248
EHPSMR7 - 680w x 5d x 700h	£235
EHPSMR6 - 580w x 5d x 700h	£222



EHPSE8
Acrylic Illustrated in Blue



Lux Desk Mounted End Return Acrylic Hygiene Protection Screen for Double Benches

- Rectangular acrylic dividing screens supplied with fixing brackets.
- Screen is clamped to the desktop.
- Brackets supplied in Silver RAL 9006 as standard.

Lux Desk Mounted End Return Screen

	Price
EHPSE8 - 780w x 5d x 700h	£248
EHPSE7 - 680w x 5d x 700h	£235
EHPSE6 - 580w x 5d x 700h	£222

Reflex Fixed Height Workstations



A sleek and elegantly angled leg frame defines the clean lines of the Reflex range giving a contemporary, executive appearance. The legs connect to a full steel sub-frame for maximum strength and stability. An optional horizontal and vertical wire management solution can be added to house cables, leaving the area free from trailing wires. Curved modesty panels are compatible with Reflex desking, adding an element of privacy and complementing the angles of the leg frame.

Lead Time: 2 Weeks

Wood: Available in MFC (Ash, Autumn Cherry, Beech, Chester Oak, English Walnut, Grey, Grey Nebraska Oak, Laurentii Wenge, Natural Nebraska Oak and White)
 Top Panel Edge Detail available on 25mm White MFC (Wenge and Black - Add £32 Retail Per Top) (Plywood - Add £42 Retail Per Top)
 Available in Veneer (Oak and Walnut) on a 3 Week Lead Time

Metalwork: Available in Silver RAL 9006 (Standard), Black Graphite RAL 9004, White RAL 9003, Chrome Effect (Add 15%) and Raw finish (Add 5%)



RR16/8

Reflex Rectangular Desk

- 2 week lead time.
- 25mm top panel.
- Tapered angled legs with steel sub-frame.
- Adjustable levelling feet.

	MFC	Veneer (3 Week Lead Time)
RR20/10 - 2000w x 1000d x 740h	£1,049	£1,574
RR18/10 - 1800w x 1000d x 740h	£1,030	£1,543
RR16/10 - 1600w x 1000d x 740h	£1,009	£1,514
RR20/8 - 2000w x 800d x 740h	£1,030	£1,543
RR18/8 - 1800w x 800d x 740h	£1,009	£1,514
RR16/8 - 1600w x 800d x 740h	£987	£1,482



RMA18/18RH

Reflex Managers Workstation

- 2 week lead time.
- 2x 25mm top panels.
- Tapered angled legs with steel sub-frame.
- Adjustable levelling feet.

	MFC	Veneer (3 Week Lead Time)
RMA20/20LH - 2000w x 2000d x 740h	£1,642	£2,463
RMA20/20RH - 2000w x 2000d x 740h	£1,642	£2,463
RMA18/20LH - 1800w x 2000d x 740h	£1,621	£2,432
RMA18/20RH - 1800w x 2000d x 740h	£1,621	£2,432
RMA16/20LH - 1600w x 2000d x 740h	£1,600	£2,400
RMA16/20RH - 1600w x 2000d x 740h	£1,600	£2,400
RMA20/18LH - 2000w x 1800d x 740h	£1,606	£2,410
RMA20/18RH - 2000w x 1800d x 740h	£1,606	£2,410
RMA18/18LH - 1800w x 1800d x 740h	£1,587	£2,379
RMA18/18RH - 1800w x 1800d x 740h	£1,587	£2,379
RMA16/18LH - 1600w x 1800d x 740h	£1,566	£2,348
RMA16/18RH - 1600w x 1800d x 740h	£1,566	£2,348



RMP16
Illustrated in red

Reflex Steel Modesty Panel

- Modesty panels are 320mm high.

	Metalwork
RMP20 - For 2000w Workstations - 1560w	£186
RMP18 - For 1800w Workstations - 1360w	£180
RMP16 - For 1600w Workstations - 1160w	£175



RCR
Illustrated in red

Reflex Cable Riser

- Compatible with all Reflex workstation legs.
- Can be retrofitted.
- Capacity to vertically enclose 1x 12mm diameter power cable.

	Metalwork
RCR	£93



RCT16
Illustrated in red

Reflex Cable Tray

- Compatible with all Reflex desks and workstations.
- High capacity cable management system neatly conceals power, data and telecom cables through a hinged cable management tray.
- Cable trays are 100mm high and 132mm deep.

	Metalwork
RCT20 - For 2000w Workstations - 1410w	£163
RCT18 - For 1800w Workstations - 1210w	£147
RCT16 - For 1600w Workstations - 1010w	£129

Lead Time: 2 Weeks

Wood: Available in MFC (Ash, Autumn Cherry, Beech, Chester Oak, English Walnut, Grey, Grey Nebraska Oak, Laurentii Wenge, Natural Nebraska Oak and White)
Top Panel Edge Detail available on 25mm White MFC (Wenge and Black - Add £32 Retail Per Top) (Plywood - Add £42 Retail Per Top)
Available in Veneer (Oak and Walnut) on a 3 Week Lead Time

Metalwork: Available in Silver RAL 9006 (Standard), Black Graphite RAL 9004, White RAL 9003, Chrome Effect (Add 15%) and Raw finish (Add 5%)
Also available in Blue RAL 5001, Coral RAL 2001, Green RAL 6016, Light Grey RAL 7038, Teal RAL 5018 and Yellow RAL 1021 (Add 12% for all)



ROCT3000



ROCT2800

Reflex Octagonal Conference Table

- 2 week lead time. • 25mm top panel. • Shared centre legs on ROCT3000.
- Tapered angled legs with steel sub-frame. • Adjustable levelling feet.

ROCT3000 - 3000w x 1400d x 740h
• 1x 3000mm Section • Seating up to 10 People

ROCT2800 - 2800w x 1200d x 740h
• 1x 2800mm Section • Seating up to 10 People

ROCT2600 - 2600w x 1200d x 740h
• 1x 2600mm Section • Seating up to 8 People

ROCT2400 - 2400w x 1000d x 740h
• 1x 2400mm Section • Seating up to 8 People

MFC	Veneer (3 Week Lead Time)
-----	---------------------------

£3,332	-
--------	---

£2,308	-
--------	---

£2,220	£2,663
--------	--------

£2,151	£2,579
--------	--------



RMT32/12

Reflex Rectangular Meeting Table

- 2 week lead time. • 2x 25mm top panels. • Shared centre legs.
- Tapered angled legs with steel sub-frame. • Adjustable levelling feet.

RMT48/14 - 2x Sections - 4800w x 1400d x 740h
RMT44/14 - 2x Sections - 4400w x 1400d x 740h
RMT40/14 - 2x Sections - 4000w x 1400d x 740h
RMT36/14 - 2x Sections - 3600w x 1400d x 740h
RMT32/14 - 2x Sections - 3200w x 1400d x 740h
RMT30/14 - 2x Sections - 3000w x 1400d x 740h

RMT48/12 - 2x Sections - 4800w x 1200d x 740h
RMT44/12 - 2x Sections - 4400w x 1200d x 740h
RMT40/12 - 2x Sections - 4000w x 1200d x 740h
RMT36/12 - 2x Sections - 3600w x 1200d x 740h
RMT32/12 - 2x Sections - 3200w x 1200d x 740h
RMT30/12 - 2x Sections - 3000w x 1200d x 740h

RMT48/10 - 2x Sections - 4800w x 1000d x 740h
RMT44/10 - 2x Sections - 4400w x 1000d x 740h
RMT40/10 - 2x Sections - 4000w x 1000d x 740h
RMT36/10 - 2x Sections - 3600w x 1000d x 740h
RMT32/10 - 2x Sections - 3200w x 1000d x 740h
RMT30/10 - 2x Sections - 3000w x 1000d x 740h

MFC	Veneer (3 Week Lead Time)
-----	---------------------------

£3,725	£4,470
--------	--------

£3,596	£4,312
--------	--------

£3,464	£4,158
--------	--------

£3,334	£4,000
--------	--------

£3,202	£3,844
--------	--------

£3,139	£3,766
--------	--------

£3,582	£4,298
--------	--------

£3,451	£4,141
--------	--------

£3,320	£3,986
--------	--------

£3,191	£3,831
--------	--------

£3,060	£3,672
--------	--------

£2,981	£3,594
--------	--------

£3,439	£4,126
--------	--------

£3,308	£3,969
--------	--------

£3,178	£3,814
--------	--------

£3,046	£3,656
--------	--------

£2,917	£3,500
--------	--------

£2,852	£3,422
--------	--------

Lead Time: 2 Weeks

Wood: Available in MFC (Ash, Autumn Cherry, Beech, Chester Oak, English Walnut, Grey, Grey Nebraska Oak, Laurentii Wenge, Natural Nebraska Oak and White)
Top Panel Edge Detail available on 25mm White MFC (Wenge and Black - Add £32 Retail Per Top) (Plywood - Add £42 Retail Per Top)
Available in Veneer (Oak and Walnut) on a 3 Week Lead Time

Metalwork: Available in Silver RAL 9006 (Standard), Black Graphite RAL 9004, White RAL 9003, Chrome Effect (Add 15%) and Raw finish (Add 5%)
Also available in Blue RAL 5001, Coral RAL 2001, Green RAL 6016, Light Grey RAL 7038, Teal RAL 5018 and Yellow RAL 1021 (Add 12% for all)



RMT16/12

Reflex Rectangular Meeting Table

- 2 week lead time. • 25mm top panel.
- Tapered angled legs with steel sub-frame. • Adjustable levelling feet.

	MFC	Veneer (3 Week Lead Time)
RMT28/14 - 1x Section - 2800w x 1400d x 740h	£2,344	-
RMT26/14 - 1x Section - 2600w x 1400d x 740h	£2,272	£2,725
RMT24/14 - 1x Section - 2400w x 1400d x 740h	£2,197	£2,636
RMT22/14 - 1x Section - 2200w x 1400d x 740h	£2,051	£2,459
RMT20/14 - 1x Section - 2000w x 1400d x 740h	£1,906	£2,287
RMT18/14 - 1x Section - 1800w x 1400d x 740h	£1,757	£2,110
RMT16/14 - 1x Section - 1600w x 1400d x 740h	£1,611	£1,933
RMT28/12 - 1x Section - 2800w x 1200d x 740h	£2,278	-
RMT26/12 - 1x Section - 2600w x 1200d x 740h	£2,205	£2,647
RMT24/12 - 1x Section - 2400w x 1200d x 740h	£2,134	£2,561
RMT22/12 - 1x Section - 2200w x 1200d x 740h	£1,988	£2,383
RMT20/12 - 1x Section - 2000w x 1200d x 740h	£1,839	£2,209
RMT18/12 - 1x Section - 1800w x 1200d x 740h	£1,692	£2,030
RMT16/12 - 1x Section - 1600w x 1200d x 740h	£1,548	£1,855
RMT14/12 - 1x Section - 1400w x 1200d x 740h	£1,482	£1,778
RMT28/10 - 1x Section - 2800w x 1000d x 740h	£2,213	-
RMT26/10 - 1x Section - 2600w x 1000d x 740h	£2,139	£2,569
RMT24/10 - 1x Section - 2400w x 1000d x 740h	£2,067	£2,480
RMT22/10 - 1x Section - 2200w x 1000d x 740h	£1,918	£2,302
RMT20/10 - 1x Section - 2000w x 1000d x 740h	£1,776	£2,130
RMT18/10 - 1x Section - 1800w x 1000d x 740h	£1,628	£1,954
RMT16/10 - 1x Section - 1600w x 1000d x 740h	£1,482	£1,778
RMT14/10 - 1x Section - 1400w x 1000d x 740h	£1,418	£1,701
RMT12/10 - 1x Section - 1200w x 1000d x 740h	£1,350	£1,621



RMT16/16

Reflex Square Meeting Table

- 2 week lead time. • 25mm top panel.
- Tapered angled legs with steel sub-frame. • Adjustable levelling feet.

	MFC	Veneer (3 Week Lead Time)
RMT20/20 - 2000w x 2000d x 740h	£2,014	£2,415
RMT18/18 - 1800w x 1800d x 740h	£1,868	£2,240
RMT16/16 - 1600w x 1600d x 740h	£1,719	£2,063
RMT14/14 - 1400w x 1400d x 740h	£1,572	£1,887
RMT12/12 - 1200w x 1200d x 740h	£1,426	£1,710
RMT10/10 - 1000w x 1000d x 740h	£1,279	£1,537



RMT/CIR16

Reflex Circular Meeting Table

- 2 week lead time. • 25mm top panel.
- Tapered angled legs with steel sub-frame. • Adjustable levelling feet.

	MFC	Veneer (3 Week Lead Time)
RMT/CIR20 - 2000w (dia) x 740h	£2,114	£2,536
RMT/CIR18 - 1800w (dia) x 740h	£1,963	£2,355
RMT/CIR16 - 1600w (dia) x 740h	£1,800	£2,161
RMT/CIR14 - 1400w (dia) x 740h	£1,675	£2,010
RMT/CIR12 - 1200w (dia) x 740h	£1,426	£1,710
RMT/CIR10 - 1000w (dia) x 740h	£1,311	£1,572

Reflex Accessories

Lead Time: Standard (All products are manufactured to order and when 'Standard Lead Time' is quoted (7 – 10 days), this may vary dependant on volume ordered, factory capacity and distribution requirements at the time of ordering. For more information please contact your Dealer Business Manager or the Customer Services Team for clarification.)

Metalwork: Available in Silver RAL 9006 (Standard), Black Graphite RAL 9004, White RAL 9003, Chrome Effect (Add 15%) and Raw finish (Add 5%)
Also available in Blue RAL 5001, Coral RAL 2001, Green RAL 6016, Light Grey RAL 7038, Teal RAL 5018 and Yellow RAL 1021 (Add 12% for all - 2 Week Lead Time)



LCTR16
Illustrated in red

Reflex Meeting Cable Tray

- Compatible with all Reflex conference / meeting tables.
- High capacity cable management system neatly conceals power, data and telecom cables through a hinged cable management tray.
- Cable trays are 180mm deep and 80mm high.

Metalwork

LCTO30	- For ROCT3000	- 1200w (2x)	£226
LCTO28	- For ROCT2800	- 1100w (2x)	£218
LCTO26	- For ROCT2600	- 1000w (2x)	£208
LCTO24	- For ROCT2400	- 900w (2x)	£190
LCTR48	- For 4800w Rectangular Meeting	- 900w (4x)	£380
LCTR44	- For 4400w Rectangular Meeting	- 800w (4x)	£356
LCTR40	- For 4000w Rectangular Meeting	- 1500w (2x)	£250
LCTR36	- For 3600w Rectangular Meeting	- 1300w (2x)	£234
LCTR32	- For 3200w Rectangular Meeting	- 1100w (2x)	£218
LCTR30	- For 3000w Rectangular Meeting	- 1000w (2x)	£208
LCTR28	- For 2800w Rectangular Meeting	- 1100w (2x)	£218
LCTR26	- For 2600w Rectangular Meeting	- 1000w (2x)	£208
LCTR24	- For 2400w Rectangular Meeting	- 900w (2x)	£190
LCTR22	- For 2200w Rectangular Meeting	- 800w (2x)	£178
LCTR20	- For 2000w Rectangular Meeting	- 1500w	£125
LCTR18	- For 1800w Rectangular Meeting	- 1300w	£117
LCTR16	- For 1600w Rectangular Meeting	- 1100w	£109
LCTR14	- For 1400w Rectangular Meeting	- 900w	£95
LCTR12	- For 1200w Rectangular Meeting	- 700w	£81
LCTS20	- For 2000w Square Meeting	- 1500w	£125
LCTS18	- For 1800w Square Meeting	- 1300w	£117
LCTS16	- For 1600w Square Meeting	- 1100w	£109
LCTS14	- For 1400w Square Meeting	- 900w	£95
LCTS12	- For 1200w Square Meeting	- 700w	£81
LCTS10	- For 1000w Square Meeting	- 500w	£64
LCTC18	- For 2000w and 1800w Circular Meeting	- 900w	£95
LCTC16	- For 1600w Circular Meeting	- 800w	£89
LCTC14	- For 1400w Circular Meeting	- 600w	£72
LCTC12	- For 1200w Circular Meeting	- 500w	£64

Reflex Accessory Compatibility

- **BLACK** - Compatible
- **BLUE** - Conflict when using screens
- **RED** - May not support larger modules
- **GREEN** - Unspecified

Workstations - Rectangular

Workstations - Managers

Meeting - Conference / Meeting (Excluding 1000w Circular)

Meeting - 1000w Circular

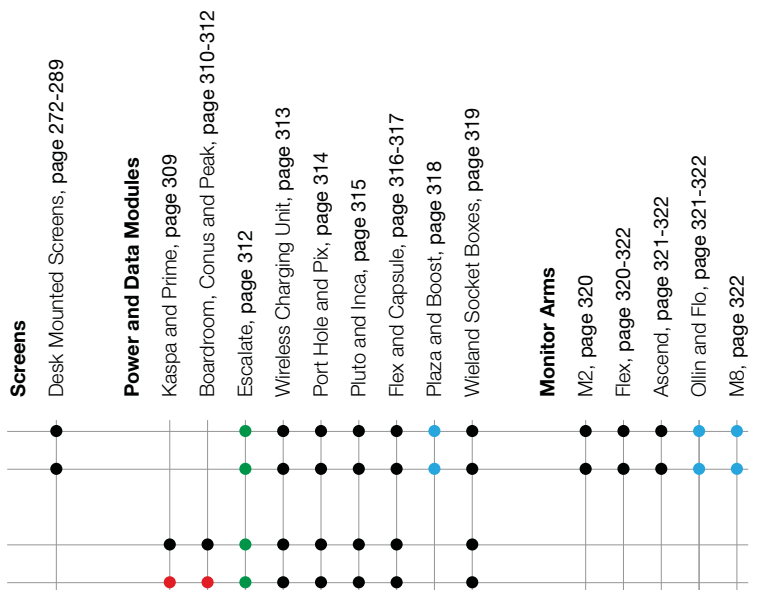

Linnea Fixed Height Workstations



Linnea is a comprehensive range offering a variety of solutions for diverse applications. It is available with an angled or goalpost leg frame, supported by a steel sub-frame offering strength and stability. Shared legs are a feature of the Linnea range, minimising the number of legs required and increasing the useable space under the workstation. Double Benches are supplied with sliding tops and horizontal wire management trays as standard, with an optional sliding top locking device, should the user require the top to be locked in the open or closed position. Limited desktop height adjustment is an option via a Spacer Kit, enabling the workstation top to elevate in increments of 25mm starting at a standard desk height of 740mm to 765mm, 790mm, and 815mm.

Linnea Workstations

Lead Time: Standard (All products are manufactured to order and when 'Standard Lead Time' is quoted (7 – 10 days), this may vary dependant on volume ordered, factory capacity and distribution requirements at the time of ordering. For more information please contact your Dealer Business Manager or the Customer Services Team for clarification.)

Wood: Available in MFC (Ash, Autumn Cherry, Beech, Chester Oak, English Walnut, Grey, Grey Nebraska Oak, Laurentii Wenge, Natural Nebraska Oak and White)
Top Panel Edge Detail available on 25mm White MFC (Wenge and Black - Add £32 Retail Per Top) (Plywood - Add £42 Retail Per Top)
Available in Veneer (Oak and Walnut) on a 3 Week Lead Time

Metalwork: Available in Silver RAL 9006 (Standard), Black Graphite RAL 9004, White RAL 9003, Chrome Effect (Add 15%) and Raw finish (Add 5%)



L16/16

Linnea Double Bench

- Complete with a central cable tray. • 2x 25mm sliding top panels.
- Available with 90 degree Linnea leg, suffix .../90 (see page 75).
- 640h mobile pedestals will protrude with 1400d and 1200d double benches, as an alternative, use MPF and MP3 pedestals (see page 226).

	MFC	Veneer (3 Week Lead Time)
L20/16 - 2000w x 1600d x 740h	£1,388	£2,078
L18/16 - 1800w x 1600d x 740h	£1,345	£2,018
L16/16 - 1600w x 1600d x 740h	£1,311	£1,965
L15/16 - 1500w x 1600d x 740h	£1,291	£1,935
L14/16 - 1400w x 1600d x 740h	£1,271	£1,905
L12/16 - 1200w x 1600d x 740h	£1,235	£1,851
L10/16 - 1000w x 1600d x 740h	£1,197	£1,796
L20/14 - 2000w x 1400d x 740h	£1,348	£2,020
L18/14 - 1800w x 1400d x 740h	£1,309	£1,962
L16/14 - 1600w x 1400d x 740h	£1,274	£1,910
L15/14 - 1500w x 1400d x 740h	£1,254	£1,880
L14/14 - 1400w x 1400d x 740h	£1,234	£1,850
L12/14 - 1200w x 1400d x 740h	£1,195	£1,792
L10/14 - 1000w x 1400d x 740h	£1,160	£1,742
L20/12 - 2000w x 1200d x 740h	£1,310	£1,963
L18/12 - 1800w x 1200d x 740h	£1,272	£1,906
L16/12 - 1600w x 1200d x 740h	£1,236	£1,852
L15/12 - 1500w x 1200d x 740h	£1,216	£1,824
L14/12 - 1400w x 1200d x 740h	£1,196	£1,794
L12/12 - 1200w x 1200d x 740h	£1,154	£1,731
L10/12 - 1000w x 1200d x 740h	£1,124	£1,685



L16/16/INT

Linnea Double Bench with Shared Inset Leg

- Complete with a central cable tray. • 2x 25mm sliding top panels.
- Available with 90 degree Linnea leg, suffix .../90 (see page 75).
- 640h mobile pedestals will protrude with 1400d and 1200d double benches, as an alternative, use MPF and MP3 pedestals (see page 226).

	MFC	Veneer (3 Week Lead Time)
L20/16/INT - 2000w x 1600d x 740h	£1,336	£2,004
L18/16/INT - 1800w x 1600d x 740h	£1,300	£1,946
L16/16/INT - 1600w x 1600d x 740h	£1,258	£1,887
L15/16/INT - 1500w x 1600d x 740h	£1,241	£1,858
L14/16/INT - 1400w x 1600d x 740h	£1,223	£1,835
L12/16/INT - 1200w x 1600d x 740h	£1,186	£1,779
L10/16/INT - 1000w x 1600d x 740h	£1,149	£1,723
L20/14/INT - 2000w x 1400d x 740h	£1,300	£1,948
L18/14/INT - 1800w x 1400d x 740h	£1,262	£1,890
L16/14/INT - 1600w x 1400d x 740h	£1,222	£1,835
L15/14/INT - 1500w x 1400d x 740h	£1,203	£1,808
L14/14/INT - 1400w x 1400d x 740h	£1,186	£1,778
L12/14/INT - 1200w x 1400d x 740h	£1,146	£1,720
L10/14/INT - 1000w x 1400d x 740h	£1,111	£1,667
L20/12/INT - 2000w x 1200d x 740h	£1,260	£1,893
L18/12/INT - 1800w x 1200d x 740h	£1,224	£1,837
L16/12/INT - 1600w x 1200d x 740h	£1,187	£1,782
L15/12/INT - 1500w x 1200d x 740h	£1,167	£1,753
L14/12/INT - 1400w x 1200d x 740h	£1,148	£1,721
L12/12/INT - 1200w x 1200d x 740h	£1,107	£1,661
L10/12/INT - 1000w x 1200d x 740h	£1,075	£1,612

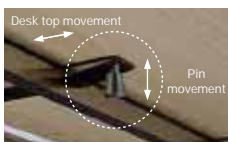

LPIN

Linnea Sliding Top Locking Pin for Double Benches

- Spring loaded locking pin allowing the double bench to be locked in open and closed positions.
- Located under bench top.

LPIN - Silver Only	Price
	£58

Linnea Workstations

Lead Time: Standard (All products are manufactured to order and when 'Standard Lead Time' is quoted (7 – 10 days), this may vary dependant on volume ordered, factory capacity and distribution requirements at the time of ordering. For more information please contact your Dealer Business Manager or the Customer Services Team for clarification.)

Wood: Available in MFC (Ash, Autumn Cherry, Beech, Chester Oak, English Walnut, Grey, Grey Nebraska Oak, Laurentii Wenge, Natural Nebraska Oak and White)
Top Panel Edge Detail available on 25mm White MFC (Wenge and Black - Add £32 Retail Per Top) (Plywood - Add £42 Retail Per Top)
Available in Veneer (Oak and Walnut) on a 3 Week Lead Time

Metalwork: Available in Silver RAL 9006 (Standard), Black Graphite RAL 9004, White RAL 9003, Chrome Effect (Add 15%) and Raw finish (Add 5%)



LR16/8

Linnea Rectangular Desk

• 25mm top panel. • Available with 90 degree Linnea leg, suffix .../90 (see page 75).

	MFC	Veneer (3 Week Lead Time)
LR20/10 - 2000w x 1000d x 740h	£725	£1,087
LR18/10 - 1800w x 1000d x 740h	£708	£1,065
LR16/10 - 1600w x 1000d x 740h	£697	£1,046
LR15/10 - 1500w x 1000d x 740h	£692	£1,037
LR14/10 - 1400w x 1000d x 740h	£687	£1,029
LR12/10 - 1200w x 1000d x 740h	£672	£1,012
LR20/8 - 2000w x 800d x 740h	£709	£1,066
LR18/8 - 1800w x 800d x 740h	£699	£1,048
LR16/8 - 1600w x 800d x 740h	£688	£1,029
LR15/8 - 1500w x 800d x 740h	£679	£1,019
LR14/8 - 1400w x 800d x 740h	£670	£1,010
LR12/8 - 1200w x 800d x 740h	£659	£987
LR10/8 - 1000w x 800d x 740h	£644	£970
LR20/7 - 2000w x 700d x 740h	£706	£1,059
LR18/7 - 1800w x 700d x 740h	£695	£1,042
LR16/7 - 1600w x 700d x 740h	£682	£1,024
LR15/7 - 1500w x 700d x 740h	£676	£1,014
LR14/7 - 1400w x 700d x 740h	£669	£1,005
LR12/7 - 1200w x 700d x 740h	£657	£985
LR10/7 - 1000w x 700d x 740h	£644	£970
LR20/6 - 2000w x 600d x 740h	£701	£1,049
LR18/6 - 1800w x 600d x 740h	£690	£1,034
LR16/6 - 1600w x 600d x 740h	£677	£1,019
LR15/6 - 1500w x 600d x 740h	£672	£1,009
LR14/6 - 1400w x 600d x 740h	£667	£996
LR12/6 - 1200w x 600d x 740h	£656	£981
LR10/6 - 1000w x 600d x 740h	£644	£970



LR16/8/INT

Linnea Rectangular Desk with Shared Inset Leg

• 25mm top panel. • Available with 90 degree Linnea leg, suffix .../90 (see page 75).

	MFC	Veneer (3 Week Lead Time)
LR20/10/INT - 2000w x 1000d x 740h	£692	£1,054
LR18/10/INT - 1800w x 1000d x 740h	£677	£1,032
LR16/10/INT - 1600w x 1000d x 740h	£667	£1,014
LR15/10/INT - 1500w x 1000d x 740h	£660	£1,007
LR14/10/INT - 1400w x 1000d x 740h	£654	£995
LR12/10/INT - 1200w x 1000d x 740h	£639	£979
LR20/8/INT - 2000w x 800d x 740h	£678	£1,034
LR18/8/INT - 1800w x 800d x 740h	£668	£1,017
LR16/8/INT - 1600w x 800d x 740h	£655	£995
LR15/8/INT - 1500w x 800d x 740h	£648	£987
LR14/8/INT - 1400w x 800d x 740h	£638	£978
LR12/8/INT - 1200w x 800d x 740h	£626	£955
LR10/8/INT - 1000w x 800d x 740h	£614	£935
LR20/7/INT - 2000w x 700d x 740h	£674	£1,026
LR18/7/INT - 1800w x 700d x 740h	£664	£1,011
LR16/7/INT - 1600w x 700d x 740h	£650	£991
LR15/7/INT - 1500w x 700d x 740h	£643	£982
LR14/7/INT - 1400w x 700d x 740h	£637	£972
LR12/7/INT - 1200w x 700d x 740h	£625	£953
LR10/7/INT - 1000w x 700d x 740h	£614	£935
LR20/6/INT - 2000w x 600d x 740h	£669	£1,018
LR18/6/INT - 1800w x 600d x 740h	£659	£1,001
LR16/6/INT - 1600w x 600d x 740h	£644	£987
LR15/6/INT - 1500w x 600d x 740h	£639	£977
LR14/6/INT - 1400w x 600d x 740h	£635	£966
LR12/6/INT - 1200w x 600d x 740h	£624	£950
LR10/6/INT - 1000w x 600d x 740h	£614	£935

Linnea Workstations

Lead Time: Standard (All products are manufactured to order and when 'Standard Lead Time' is quoted (7 – 10 days), this may vary dependant on volume ordered, factory capacity and distribution requirements at the time of ordering. For more information please contact your Dealer Business Manager or the Customer Services Team for clarification.)

Wood: Available in MFC (Ash, Autumn Cherry, Beech, Chester Oak, English Walnut, Grey, Grey Nebraska Oak, Laurentii Wenge, Natural Nebraska Oak and White)
Top Panel Edge Detail available on 25mm White MFC (Wenge and Black - Add £32 Retail Per Top) (Plywood - Add £42 Retail Per Top)
Available in Veneer (Oak and Walnut) on a 3 Week Lead Time

Metalwork: Available in Silver RAL 9006 (Standard), Black Graphite RAL 9004, White RAL 9003, Chrome Effect (Add 15%) and Raw finish (Add 5%)



L16/10/8RH

Linnea Angular Workstation

- 25mm top panel. • Available with 90 degree Linnea leg, suffix .../90 (see page 75).
- 600mm return.

	MFC	Veneer (3 Week Lead Time)
L20/10/8LH - 2000w x 1000-800d x 740h	£770	£1,155
L20/10/8RH - 2000w x 1000-800d x 740h	£770	£1,155
L18/10/8LH - 1800w x 1000-800d x 740h	£762	£1,138
L18/10/8RH - 1800w x 1000-800d x 740h	£762	£1,138
L16/10/8LH - 1600w x 1000-800d x 740h	£744	£1,115
L16/10/8RH - 1600w x 1000-800d x 740h	£744	£1,115
L14/10/8LH - 1400w x 1000-800d x 740h	£732	£1,098
L14/10/8RH - 1400w x 1000-800d x 740h	£732	£1,098
L20/8/6LH - 2000w x 800-600d x 740h	£763	£1,142
L20/8/6RH - 2000w x 800-600d x 740h	£763	£1,142
L18/8/6LH - 1800w x 800-600d x 740h	£745	£1,119
L18/8/6RH - 1800w x 800-600d x 740h	£745	£1,119
L16/8/6LH - 1600w x 800-600d x 740h	£732	£1,098
L16/8/6RH - 1600w x 800-600d x 740h	£732	£1,098
L14/8/6LH - 1400w x 800-600d x 740h	£723	£1,079
L14/8/6RH - 1400w x 800-600d x 740h	£723	£1,079



LC120/12/8

Linnea 120 Degree Cluster Workstation

- 25mm top panel. • Configured as a 3 person module.
- Available with 90 degree Linnea leg, suffix .../90 (see page 75).

	MFC	Veneer (3 Week Lead Time)
LC120/12/8 - 2886w (dia) x 1200-800d x 740h	£2,698	£3,903
LC120/12/6 - 2886w (dia) x 1200-600d x 740h	£2,562	£3,712
LC120/10/6 - 2329w (dia) x 1000-600d x 740h	£2,424	£3,514



LC120/12/8/INT

Linnea 120 Degree Cluster Workstation with Shared Inset Leg

- 25mm top panel. • Configured as a 3 person module.
- Comes with 1x full leg and 1x inset leg.
- Available with 90 degree Linnea leg, suffix .../90 (see page 75).

	MFC	Veneer (3 Week Lead Time)
LC120/12/8/INT - 2886w (dia) x 1200-800d x 740h	£2,698	£3,903
LC120/12/6/INT - 2886w (dia) x 1200-600d x 740h	£2,562	£3,712
LC120/10/6/INT - 2329w (dia) x 1000-600d x 740h	£2,424	£3,514



LRR18

Linnea Radius Reception Desk

- 25mm top panel. • Available with 90 degree Linnea leg, suffix .../90 (see page 75).

	MFC	Veneer (3 Week Lead Time)
LRR20 - 2000w (extreme) x 800d x 740h	£1,187	£1,723
LRR18 - 1800w (extreme) x 800d x 740h	£1,071	£1,550

Linnea Returns and Extensions

Lead Time: Standard (All products are manufactured to order and when 'Standard Lead Time' is quoted (7 – 10 days), this may vary dependant on volume ordered, factory capacity and distribution requirements at the time of ordering. For more information please contact your Dealer Business Manager or the Customer Services Team for clarification.)

Wood: Available in MFC (Ash, Autumn Cherry, Beech, Chester Oak, English Walnut, Grey, Grey Nebraska Oak, Laurentii Wenge, Natural Nebraska Oak and White)
Top Panel Edge Detail available on 25mm White MFC (Wenge and Black - Add £32 Retail Per Top) (Plywood - Add £42 Retail Per Top)
Available in Veneer (Oak and Walnut) on a 3 Week Lead Time

Metalwork: Available in Silver RAL 9006 (Standard), Black Graphite RAL 9004, White RAL 9003, Chrome Effect (Add 15%) and Raw finish (Add 5%)



LSR10/6RH

Linnea Secretarial Return

- 25mm top panel.
- Available with 90 degree Linnea leg, suffix **.../90** (see page 75).

	MFC	Veneer (3 Week Lead Time)
LSR12/8LH... - 1200w x 800d x 740h	£491	£735
LSR12/8RH... - 1200w x 800d x 740h	£491	£735
LSR10/8LH... - 1000w x 800d x 740h	£474	£709
LSR10/8RH... - 1000w x 800d x 740h	£474	£709
LSR12/6LH... - 1200w x 600d x 740h	£464	£692
LSR12/6RH... - 1200w x 600d x 740h	£464	£692
LSR10/6LH... - 1000w x 600d x 740h	£443	£660
LSR10/6RH... - 1000w x 600d x 740h	£443	£660

- For Rectangular Desking, use standard code
- For Angular Workstations, suffix **.../X** on 600d Secretarial Returns only



LCME16/6

Linnea Curved Extension

- 25mm top panel.

For No Screens and All 120 Degree Clusters

	MFC	Veneer (3 Week Lead Time)
LCME16/6 - For 1600mm Ends - 1600w x 650d x 740h	£672	£1,012
LCME14/5 - For 1400mm Ends - 1400w x 500d x 740h	£660	£990
LCME12/5 - For 1200mm Ends - 1200w x 500d x 740h	£648	£972

For Contract or System Screens

LCME16/6/S - For 1600mm Ends - 1627w x 650d x 740h	£672	£1,012
LCME14/5/S - For 1400mm Ends - 1427w x 500d x 740h	£660	£990
LCME12/5/S - For 1200mm Ends - 1227w x 500d x 740h	£648	£972

For Acoustic Screens

LCME16/6/A - For 1600mm Ends - 1638w x 650d x 740h	£672	£1,012
LCME14/5/A - For 1400mm Ends - 1438w x 500d x 740h	£660	£990
LCME12/5/A - For 1200mm Ends - 1238w x 500d x 740h	£648	£972



LCME16/6/S



LSME16/6

Linnea Straight Extension

- 25mm top panel.

For No Screens and All 120 Degree Clusters

	MFC	Veneer (3 Week Lead Time)
LSME16/6 - For 1600mm Ends - 1600w x 650d x 740h	£672	£1,012
LSME14/5 - For 1400mm Ends - 1400w x 500d x 740h	£660	£990
LSME12/5 - For 1200mm Ends - 1200w x 500d x 740h	£648	£972

For Contract or System Screens

LSME16/6/S - For 1600mm Ends - 1627w x 650d x 740h	£672	£1,012
LSME14/5/S - For 1400mm Ends - 1427w x 500d x 740h	£660	£990
LSME12/5/S - For 1200mm Ends - 1227w x 500d x 740h	£648	£972

For Acoustic Screens

LSME16/6/A - For 1600mm Ends - 1638w x 650d x 740h	£672	£1,012
LSME14/5/A - For 1400mm Ends - 1438w x 500d x 740h	£660	£990
LSME12/5/A - For 1200mm Ends - 1238w x 500d x 740h	£648	£972



LSME16/6/S

Linnea Accessories

Lead Time: Standard (All products are manufactured to order and when 'Standard Lead Time' is quoted (7 – 10 days), this may vary dependant on volume ordered, factory capacity and distribution requirements at the time of ordering. For more information please contact your Dealer Business Manager or the Customer Services Team for clarification.)

Wood: Available in MFC (Ash, Autumn Cherry, Beech, Chester Oak, English Walnut, Grey, Grey Nebraska Oak, Laurentii Wenge, Natural Nebraska Oak and White) Available in Veneer (Oak and Walnut) on a 3 Week Lead Time

Metalwork: Available in Silver RAL 9006 (Standard), Black Graphite RAL 9004, White RAL 9003, Chrome Effect (Add 15%) and Raw finish (Add 5%)



LDDSE16

Linnea Decorative Slab End and Leg Frame

- 25mm top panel.
- Designed to cover the ends of Linnea runs of desks.
- Can be retrofitted.
- For use on one end of the workstation (for use on both ends, specify 2x slab ends).
- Available for 90 degree Linnea leg, suffix **.../90** (see below).

	MFC	Veneer (3 Week Lead Time)
LDDSE16 - For 1600d Ends	£480	£577
LDDSE14 - For 1400d Ends	£470	£564
LDDSE12 - For 1200d Ends	£458	£549
LSDSE10 - For 1000d Ends	£438	£525
LSDSE08 - For 800d Ends	£416	£499
LSDSE07 - For 700d Ends	£407	£485
LSDSE06 - For 600d Ends	£394	£473



LCP16/INT
Illustrated in red

Linnea Inset Vertical Leg Wire Management Plates

- Designed to conceal cables passing vertically into the horizontal cable trays.
- Can be retrofitted.
- Available for 90 degree Linnea leg, suffix **.../90** (see below).

	Metalwork
LCP16/INT - For 1600d Ends	£208
LCP14/INT - For 1400d Ends	£205
LCP12/INT - For 1200d Ends	£201



L16/16/90
Illustrated in red

Linnea Optional 90 Degree Linnea Leg

- Replaced standard angled Linnea legs with 90 degree versions.
- Suffix **.../90** to the end of relevant Linnea codes.
- No upcharge.

	Price
.../90 - 90 Degree Linnea Leg	£0



LR16/8/90
Illustrated in red



Black Nanotech - Contact Customer Services for specification, prices and lead time.

Linnea Accessories

Lead Time: Standard (All products are manufactured to order and when 'Standard Lead Time' is quoted (7 – 10 days), this may vary dependant on volume ordered, factory capacity and distribution requirements at the time of ordering. For more information please contact your Dealer Business Manager or the Customer Services Team for clarification.)

Metalwork: Cable Risers: Available in Silver RAL 9006 (Standard), Black Graphite RAL 9004, White RAL 9003, Chrome Effect (Add 15%) and Raw finish (Add 5%)
 Others: Available in Blue RAL 5001, Coral RAL 2001, Green RAL 6016, Light Grey RAL 7038, Teal RAL 5018 and Yellow RAL 1021 (Add 12% for all - 2 Week Lead Time)
 Available in Silver RAL 9006 (Standard), Black Graphite RAL 9004, White RAL 9003, Chrome Effect (Add 15%) and Raw finish (Add 5%)



LHSS/16D
 Illustrated in red

Linnea Height Settable Spacers for Double Benches

- Supplied with 12x 25mm, 12x 50mm and 12x 75mm top spacers and 6 single arms.
- Single arms replace the double shared arms. • Adjusts both worktops and enables them to slide.

Metalwork

LHSS/16D - For 1600d Ends	_____	£161
LHSS/14D - For 1400d Ends	_____	£157
LHSS/12D - For 1200d Ends	_____	£154



LHSS/S
 Illustrated in red

Linnea Height Settable Spacers for Single Workstations

- Supplied with 6x 25mm, 6x 50mm and 6x 75mm top spacers.

Metalwork

LHSS/S - For 1000d, 800d, 700d and 600d Ends	_____	£73
---	-------	-----



LRMP16
 Illustrated in red

Linnea Steel Modesty Panel

- Modesty panels are 275mm high.

Metalwork

LRMP20 - For 2000w Workstations	- 1760w _____	£186
LRMP18 - For 1800w Workstations	- 1560w _____	£180
LRMP16 - For 1600w Workstations	- 1360w _____	£175
LRMP15 - For 1500w Workstations	- 1260w _____	£173
LRMP14 - For 1400w Workstations	- 1160w _____	£171
LRMP12 - For 1200w Workstations	- 960w _____	£169
LRMP10 - For 1000w Workstations	- 760w _____	£163
LRRMP20 - For LRR20	- 1380w _____	£186
LRRMP18 - For LRR18	- 1260w _____	£180



LLCR
 Illustrated in red

Linnea Cable Risers

- Single channel cable riser (2 per pack).

Metalwork

LLCR	_____	£46
-------------	-------	-----



LRCT16
 Illustrated in red

Linnea Cable Tray

- Cable trays can be accessed from the front or back of the desk via the easy slot and hook design.
- Cable trays are 222mm deep and 56mm high.
- Cable trays will only accept 2 gang sockets such as SK2/S (see page 319).

Metalwork

LRCT20 - For 2000w Workstations	- 1470w _____	£163
LRCT18 - For 1800w Workstations	- 1270w _____	£148
LRCT16 - For 1600w Workstations	- 1070w _____	£129
LRCT15 - For 1500w Workstations and LRR20	- 970w _____	£121
LRCT14 - For 1400w Workstations and LRR18	- 870w _____	£111
LRCT12 - For 1200w Workstations	- 670w _____	£100
LRCT10 - For 1000w Workstations	- 470w _____	£85
L120D12 - For 1200w 120 Degree Clusters	- 850w _____	£113
L120D10 - For 1000w 120 Degree Clusters	- 630w _____	£100

Linnea Accessories and Conference / Meeting Tables

Lead Time: Standard (All products are manufactured to order and when 'Standard Lead Time' is quoted (7 – 10 days), this may vary dependant on volume ordered, factory capacity and distribution requirements at the time of ordering. For more information please contact your Dealer Business Manager or the Customer Services Team for clarification.)

Wood: Available in MFC (Ash, Autumn Cherry, Beech, Chester Oak, English Walnut, Grey, Grey Nebraska Oak, Laurentii Wenge, Natural Nebraska Oak and White)
Top Panel Edge Detail available on 25mm White MFC (Wenge and Black - Add £32 Retail Per Top) (Plywood - Add £42 Retail Per Top)
Available in Veneer (Oak and Walnut) on a 3 Week Lead Time

Metalwork: Available in Silver RAL 9006 (Standard), Black Graphite RAL 9004, White RAL 9003, Chrome Effect (Add 15%) and Raw finish (Add 5%)
Also available in Blue RAL 5001, Coral RAL 2001, Green RAL 6016, Light Grey RAL 7038, Teal RAL 5018 and Yellow RAL 1021 (Add 12% for all - 2 Week Lead Time)



LCPU/W and LCPU

Linnea CPU Holder

- Includes Linnea mounting kit.
- Adjustable CPU holder for PC towers.
- Rotates a full 360 degrees for complete access to cables and ports.

	Price
LCPU - Black Trim	£192
LCPU/W - White Trim	£192



2LM2BS

Showing Bolt Through Version

M2 Monitor Arm

- Post mounted monitor arm with spring assisted tension.

	Price
2LM2CS/TFC - Silver Clamp on Desk Fixing	£304
2LM2CW/TFC - White Clamp on Desk Fixing	£304
• Spring Assisted Tension Height Adjustment	



SCR/S - SCR/B - SCR/W

Slinky Cable Riser

- Suitable for all desking ranges.

	Price
SCR/S - Silver	£59
SCR/B - Black	£59
SCR/W - White	£59



LCONF44



LCONF24

Linnea Double 'D' Ended Conference Table

- 25mm top panel.
- Available with 90 degree Linnea leg, suffix .../90 (see page 75).

	MFC	Veneer (3 Week Lead Time)
LCONF48 - 4800w x 1200d x 740h • 2x 1700mm and 1x 1400mm Sections • Seating up to 16 People	£2,937	£4,405
LCONF44 - 4400w x 1200d x 740h • 2x 2200mm Sections • Seating up to 14 People	£2,619	£3,927
LCONF34 - 3400w x 1200d x 740h • 2x 1700mm Sections • Seating up to 10 People	£2,215	£3,325
LCONF24 - 2400w x 1200d x 740h • 1x 2400mm Section • Seating up to 8 People	£1,542	£2,315
LCONF20 - 2000w x 1200d x 740h • 1x 2000mm Section • Seating up to 6 People	£1,276	£1,914

Linnea Conference / Meeting Tables

Lead Time: Standard (All products are manufactured to order and when 'Standard Lead Time' is quoted (7 – 10 days), this may vary dependant on volume ordered, factory capacity and distribution requirements at the time of ordering. For more information please contact your Dealer Business Manager or the Customer Services Team for clarification.)

Wood: Available in MFC (Ash, Autumn Cherry, Beech, Chester Oak, English Walnut, Grey, Grey Nebraska Oak, Laurentii Wenge, Natural Nebraska Oak and White)
Top Panel Edge Detail available on 25mm White MFC (Wenge and Black - Add £32 Retail Per Top) (Plywood - Add £42 Retail Per Top)
Available in Veneer (Oak and Walnut) on a 3 Week Lead Time

Metalwork: Available in Silver RAL 9006 (Standard), Black Graphite RAL 9004, White RAL 9003, Chrome Effect (Add 15%) and Raw finish (Add 5%)
Also available in Blue RAL 5001, Coral RAL 2001, Green RAL 6016, Light Grey RAL 7038, Teal RAL 5018 and Yellow RAL 1021 (Add 12% for all - 2 Week Lead Time)



LMT16/12

Linnea Meeting Table

• 25mm top panel. • Available with 90 degree Linnea leg, suffix .../90 (see page 75).

	MFC	Veneer (3 Week Lead Time)
LMT20/16 - 2000w x 1600d x 740h	£1,061	£1,589
LMT18/16 - 1800w x 1600d x 740h	£1,012	£1,517
LMT16/16 - 1600w x 1600d x 740h	£964	£1,446
LMT20/12 - 2000w x 1200d x 740h	£958	£1,439
LMT18/12 - 1800w x 1200d x 740h	£948	£1,421
LMT16/12 - 1600w x 1200d x 740h	£932	£1,399
LMT14/12 - 1400w x 1200d x 740h	£918	£1,379
LMT12/12 - 1200w x 1200d x 740h	£905	£1,355
LMT20/10 - 2000w x 1000d x 740h	£725	£1,087
LMT18/10 - 1800w x 1000d x 740h	£708	£1,065
LMT16/10 - 1600w x 1000d x 740h	£697	£1,046
LMT14/10 - 1400w x 1000d x 740h	£688	£1,029
LMT12/10 - 1200w x 1000d x 740h	£672	£1,012
LMT10/10 - 1000w x 1000d x 740h	£663	£991
LMT20/8 - 2000w x 800d x 740h	£709	£1,066
LMT18/8 - 1800w x 800d x 740h	£699	£1,048
LMT16/8 - 1600w x 800d x 740h	£688	£1,029
LMT14/8 - 1400w x 800d x 740h	£670	£1,006
LMT12/8 - 1200w x 800d x 740h	£659	£987
LMT10/8 - 1000w x 800d x 740h	£644	£970



LMT16/12/INT

Linnea Meeting Table

• 25mm top panel. • Available with 90 degree Linnea leg, suffix .../90 (see page 75).

	MFC	Veneer (3 Week Lead Time)
LMT20/16/INT - 2000w x 1600d x 740h	£1,011	£1,540
LMT18/16/INT - 1800w x 1600d x 740h	£962	£1,468
LMT16/16/INT - 1600w x 1600d x 740h	£915	£1,397
LMT20/12/INT - 2000w x 1200d x 740h	£911	£1,391
LMT18/12/INT - 1800w x 1200d x 740h	£898	£1,372
LMT16/12/INT - 1600w x 1200d x 740h	£883	£1,350
LMT14/12/INT - 1400w x 1200d x 740h	£868	£1,329
LMT12/12/INT - 1200w x 1200d x 740h	£858	£1,307
LMT20/10/INT - 2000w x 1000d x 740h	£676	£1,037
LMT18/10/INT - 1800w x 1000d x 740h	£659	£1,015
LMT16/10/INT - 1600w x 1000d x 740h	£650	£995
LMT14/10/INT - 1400w x 1000d x 740h	£638	£979
LMT12/10/INT - 1200w x 1000d x 740h	£622	£962
LMT10/10/INT - 1000w x 1000d x 740h	£615	£942

Linnea Accessories

Lead Time: Standard (All products are manufactured to order and when 'Standard Lead Time' is quoted (7 – 10 days), this may vary dependant on volume ordered, factory capacity and distribution requirements at the time of ordering. For more information please contact your Dealer Business Manager or the Customer Services Team for clarification.)

Metalwork: Available in Silver RAL 9006 (Standard), Black Graphite RAL 9004, White RAL 9003, Chrome Effect (Add 15%) and Raw finish (Add 5%)
Also available in Blue RAL 5001, Coral RAL 2001, Green RAL 6016, Light Grey RAL 7038, Teal RAL 5018 and Yellow RAL 1021 (Add 12% for all - 2 Week Lead Time)



LINCTC24
Illustrated in red

Linnea Conference / Meeting Cable Tray

- Tray can be positioned to the users side of the workstation or towards the middle.
- Cable trays are 100mm deep and 110mm high.

Model	Description	Price	Metalwork
LINCTC48	- For LCONF48 - 1030w (3x)	£333	
LINCTC44	- For LCONF44 - 1630w (2x)	£326	
LINCTC34	- For LCONF34 - 1030w (2x)	£222	
LINCTC24	- For LCONF24 - 1430w	£148	
LINCTC20	- For LCONF20 - 1030w	£111	
LINCTM20	- For 2000w and 1600d and 1200d Meeting Tables - 1630w	£163	
LINCTM18	- For 1800w and 1600d and 1200d Meeting Tables - 1430w	£148	
LINCTM16	- For 1600w and 1600d and 1200d Meeting Tables - 1230w	£129	
LINCTM14	- For 1400w and 1600d and 1200d Meeting Tables - 1030w	£111	
LINCTM12	- For 1200w and 1600d and 1200d Meeting Tables - 830w	£100	
LINCTM10	- For 1000w and 1600d and 1200d Meeting Tables - 630w	£85	



LRCT16
Illustrated in red

Linnea Meeting Cable Tray

- Cable trays can be accessed from the front or back of the desk via the easy slot and hook design.
- Cable trays are 222mm deep and 56mm high.
- Cable trays will only accept 2 gang sockets such as SK2/S (see page 319).

Model	Description	Price	Metalwork
LRCT20	- For 2000w and 1000d and 800d Meeting Tables - 1470w	£163	
LRCT18	- For 1800w and 1000d and 800d Meeting Tables - 1270w	£148	
LRCT16	- For 1600w and 1000d and 800d Meeting Tables - 1070w	£129	
LRCT14	- For 1400w and 1000d and 800d Meeting Tables - 870w	£111	
LRCT12	- For 1200w and 1000d and 800d Meeting Tables - 670w	£100	
LRCT10	- For 1000w and 1000d and 800d Meeting Tables - 470w	£85	

Linnea Accessory Compatibility

- **BLACK** - Compatible
- **BLUE** - Conflict when using screens
- **GREEN** - Unspecified

Accessory	Screens	Power and Data Modules	Monitor Arms
Workstations - Double Benches	Linnea Screens, page 80-90	Kaspa and Prime, page 309 Boardroom, Conus and Peak, page 310-312 Escalate, page 312 Wireless Charging Unit, page 313 Port Hole and Pix, page 314 Pluto and Inca, page 315 Flex and Capsule, page 316-317 Plaza and Boost, page 318 Wieland Socket Boxes, page 319	M2, page 320 Flex, page 320-322 Ascend, page 321-322 Ollin and Flo, page 321-322 M8, page 322
Workstations - Rectangular	●	●	●
Workstations - Angular	●	●	●
Workstations - Secretarial Return	●	●	●
Workstations - Radius Reception	●	●	●
Workstations - 120 Degree Cluster	●	●	●
Extensions			
Meeting - Conference / Meeting		●	

Linnea System and Acoustic Screens for Double Benches

Lead Time: Standard (All products are manufactured to order and when 'Standard Lead Time' is quoted (7 – 10 days), this may vary dependant on volume ordered, factory capacity and distribution requirements at the time of ordering. For more information please contact your Dealer Business Manager or the Customer Services Team for clarification.)

Metalwork: Available in Anodised Silver (Standard), Black Graphite RAL 9004 and White RAL 9003

Fabric: Fully upholstered with pinnable surface available in Groups 1-7

Acrylic: Available in Blue, Green, Orange, Red, Frosted and Clear

MFC: Available in Ash, Autumn Cherry, Beech, Chester Oak, English Walnut, Grey, Grey Nebraska Oak, Laurentii Wenge, Natural Nebraska Oak and White

Linnea Desk Mounted System Screen for Double Benches

- Straight dividing screens with aluminium trim and optional management rail.
- Screen is bracketed to the double bench leg frames.
- Optional 4 way link post available (**ELLP410**).
- Available as Hygiene Protection Screens and add-ons (see page 87-90).



- For Fabric, suffix **...F**
- For Acrylic, suffix **...A**
- For MFC without Management Rail, suffix **...MFC**
- For MFC with Management Rail, suffix **.../MFC**

Straight System Screen

	Group 1	Group 2	Group 3	Group 4	Group 5	Group 6	Group 7	Acrylic	MFC
ELSS20... - 1973w x 27d x 375h	£444	£456	£468	£480	£492	£504	£516	£444	£401
ELSS18... - 1773w x 27d x 375h	£419	£431	£443	£455	£467	£479	£491	£419	£382
ELSS16... - 1573w x 27d x 375h	£385	£397	£409	£421	£433	£445	£457	£385	£351
ELSS15... - 1473w x 27d x 375h	£371	£383	£395	£407	£419	£431	£443	£371	£337
ELSS14... - 1373w x 27d x 375h	£357	£369	£381	£393	£405	£417	£429	£357	£324
ELSS12... - 1173w x 27d x 375h	£325	£337	£349	£361	£373	£385	£397	£325	£295
ELSS10... - 973w x 27d x 375h	£307	£319	£331	£343	£355	£367	£379	£307	£280

Straight System Screen with Management Rail

ELSS20M... - 1973w x 27d x 375h	£597	£609	£621	£633	£645	£657	£669	£597	£538
ELSS18M... - 1773w x 27d x 375h	£559	£571	£583	£595	£607	£619	£631	£559	£507
ELSS16M... - 1573w x 27d x 375h	£516	£528	£540	£552	£564	£576	£588	£516	£469
ELSS15M... - 1473w x 27d x 375h	£485	£497	£509	£521	£533	£545	£557	£485	£451
ELSS14M... - 1373w x 27d x 375h	£454	£466	£478	£490	£502	£514	£526	£454	£431
ELSS12M... - 1173w x 27d x 375h	£422	£434	£446	£458	£470	£482	£494	£422	£382
ELSS10M... - 973w x 27d x 375h	£385	£397	£409	£421	£433	£445	£457	£385	£348

Link Post

ELLP410 - 4 Way	£72
------------------------	-----

Linnea Desk Mounted Acoustic Screen for Double Benches

- Straight dividing screens faced with 6mm polyester fibre insulation board.
- Screen is bracketed to the double bench leg frames.
- Link post not required.
- Available as Hygiene Protection Screens and add-ons (see page 87-90).

• Class B certified in accordance with International Standards:

- ISO 354:2003
- ISO 11654:1997
- ISO 9613-1:1993



Straight Acoustic Screen

	Group 1	Group 2	Group 3	Group 4	Group 5	Group 6	Group 7
AELSS20F - 1973w x 38d x 375h	£557	£569	£581	£593	£605	£617	£629
AELSS18F - 1773w x 38d x 375h	£526	£538	£550	£562	£574	£586	£598
AELSS16F - 1573w x 38d x 375h	£482	£494	£506	£518	£530	£542	£554
AELSS15F - 1473w x 38d x 375h	£465	£477	£489	£501	£513	£525	£537
AELSS14F - 1373w x 38d x 375h	£449	£461	£473	£485	£497	£509	£521
AELSS12F - 1173w x 38d x 375h	£409	£421	£433	£445	£457	£469	£481
AELSS10F - 973w x 38d x 375h	£386	£398	£410	£422	£434	£446	£458

Linnea Return System Screens for Double Benches

Lead Time: Standard (All products are manufactured to order and when 'Standard Lead Time' is quoted (7 – 10 days), this may vary dependant on volume ordered, factory capacity and distribution requirements at the time of ordering. For more information please contact your Dealer Business Manager or the Customer Services Team for clarification.)

Metalwork: Available in Anodised Silver (Standard), Black Graphite RAL 9004 and White RAL 9003

Fabric: Fully upholstered with pinnable surface available in Groups 1-7

Acrylic: Available in Blue, Green, Orange, Red, Frosted and Clear

MFC: Available in Ash, Autumn Cherry, Beech, Chester Oak, English Walnut, Grey, Grey Nebraska Oak, Laurentii Wenge, Natural Nebraska Oak and White

Linnea Desk Mounted Mid Return System Screen for Double Benches

- Straight dividing screens with aluminium trim.
- Screen is fixed to the link post at one end and uses a metal blade between the desk tops to fix its position.
- 4 way link post required (**ELLP410**).
- Available as Hygiene Protection Screens and add-ons (**see page 87-90**).

- For Fabric, suffix **...F**
- For Acrylic, suffix **...A**
- For MFC, suffix **...MFC**



Straight System Screen	Group 1	Group 2	Group 3	Group 4	Group 5	Group 6	Group 7	Acrylic	MFC
ESSMR8... - 773w x 27d x 375h	£295	£307	£319	£331	£343	£355	£367	£295	£263
ESSMR7... - 673w x 27d x 375h	£288	£300	£312	£324	£336	£348	£360	£288	£259
ESSMR6... - 573w x 27d x 375h	£282	£294	£306	£318	£330	£342	£354	£282	£251

Link Post

ELLP410 - 4 Way | £72 |

Linnea Desk Mounted Flexible Return Screen for Double Benches

- Desk mounted curved dividing screens.
- Screen hooks over existing screens at any position and is stabilised by a flat foot.



Curved Acrylic Screen

Curved Acrylic Screen	Acrylic
ELSSRC8A - 780w x 5d x 375-200h	£255
ELSSRC7A - 680w x 5d x 375-200h	£245
ELSSRC6A - 580w x 5d x 375-200h	£235



Lead Time: Standard (All products are manufactured to order and when 'Standard Lead Time' is quoted (7 – 10 days), this may vary dependant on volume ordered, factory capacity and distribution requirements at the time of ordering. For more information please contact your Dealer Business Manager or the Customer Services Team for clarification.)

Fabric: Fully upholstered with pinnable surface available in Groups 1-7

Linnea Desk Mounted Flexible Return Contract Screen for Double Benches

- 2 week lead time.
- Straight dividing screen with rounded corners.
- Screen slides onto the front of the desktop at desired position and can be moved at any time.
- Screens overhang the front of the desktop by 143mm.



Straight Contract Screen

	Group 1	Group 2	Group 3	Group 4	Group 5	Group 6	Group 7
ECSFR10 - 1100w x 36d x 375h	£340	£352	£364	£376	£388	£400	£412
ECSFR8 - 900w x 36d x 375h	£329	£341	£353	£365	£377	£389	£401
ECSFR7 - 800w x 36d x 375h	£322	£334	£346	£358	£370	£382	£394
ECSFR6 - 700w x 36d x 375h	£317	£329	£341	£353	£365	£377	£389

Linnea Desk Mounted Contract Screen for Double Benches

- Straight dividing screens with pinnable or non-pinnable fully upholstered surface.
- Pullover style fabric application.
- Screen is bracketed to the double bench leg frames.
- Link post not required.
- Available as Hygiene Protection Screens and add-ons (see page 87-90).



Straight Pinnable Contract Screen

	Group 1	Group 2	Group 3	Group 4	Group 5	Group 6	Group 7
ELPCS20FP - 1973w x 38d x 375h	£281	£293	£305	£317	£329	£341	£353
ELPCS18FP - 1773w x 38d x 375h	£270	£282	£294	£306	£318	£330	£342
ELPCS16FP - 1573w x 38d x 375h	£261	£273	£285	£297	£309	£321	£333
ELPCS15FP - 1473w x 38d x 375h	£255	£267	£279	£291	£303	£315	£327
ELPCS14FP - 1373w x 38d x 375h	£248	£260	£272	£284	£296	£308	£320
ELPCS12FP - 1173w x 38d x 375h	£236	£248	£260	£272	£284	£296	£308
ELPCS10FP - 973w x 38d x 375h	£223	£235	£247	£259	£271	£283	£295

Straight Contract Screen

ELPCS20F - 1973w x 25d x 375h	£257	£269	£281	£293	£305	£317	£329
ELPCS18F - 1773w x 25d x 375h	£245	£257	£269	£281	£293	£305	£317
ELPCS16F - 1573w x 25d x 375h	£236	£248	£260	£272	£284	£296	£308
ELPCS15F - 1473w x 25d x 375h	£231	£243	£255	£267	£279	£291	£303
ELPCS14F - 1373w x 25d x 375h	£225	£237	£249	£261	£273	£285	£297
ELPCS12F - 1173w x 25d x 375h	£211	£223	£235	£247	£259	£271	£283
ELPCS10F - 973w x 25d x 375h	£199	£211	£223	£235	£247	£259	£271

Linnea System and Acoustic Screens for Single Desks

Lead Time: Standard (All products are manufactured to order and when 'Standard Lead Time' is quoted (7 – 10 days), this may vary dependant on volume ordered, factory capacity and distribution requirements at the time of ordering. For more information please contact your Dealer Business Manager or the Customer Services Team for clarification.)

Metalwork: Available in Anodised Silver (Standard), Black Graphite RAL 9004 and White RAL 9003

Fabric: Fully upholstered with pinnable surface available in Groups 1-7

Acrylic: Available in Blue, Green, Orange, Red, Frosted and Clear

MFC: Available in Ash, Autumn Cherry, Beech, Chester Oak, English Walnut, Grey, Grey Nebraska Oak, Laurentii Wenge, Natural Nebraska Oak and White

Linnea Desk Mounted System Screen for Single Desks

- Straight dividing screens with aluminium trim and optional management rail.
- Screen is bracketed to the outer edge of the desk top.
- Optional 4 way link post available (**ELP375**).
- Available as Hygiene Protection Screens and add-ons (see page 87-90).



- For Fabric, suffix **...F**
- For Acrylic, suffix **...A**
- For MFC without Management Rail, suffix **...MFC**
- For MFC with Management Rail, suffix **.../MFC**

Straight System Screen

	Group 1	Group 2	Group 3	Group 4	Group 5	Group 6	Group 7	Acrylic	MFC
ESS20... - 1973w x 27d x 375h	£444	£456	£468	£480	£492	£504	£516	£444	£401
ESS18... - 1773w x 27d x 375h	£419	£431	£443	£455	£467	£479	£491	£419	£382
ESS16... - 1573w x 27d x 375h	£385	£397	£409	£421	£433	£445	£457	£385	£351
ESS15... - 1473w x 27d x 375h	£371	£383	£395	£407	£419	£431	£443	£371	£337
ESS14... - 1373w x 27d x 375h	£357	£369	£381	£393	£405	£417	£429	£357	£324
ESS12... - 1173w x 27d x 375h	£325	£337	£349	£361	£373	£385	£397	£325	£295
ESS10... - 973w x 27d x 375h	£307	£319	£331	£343	£355	£367	£379	£307	£280

Straight System Screen with Management Rail

ESS20M... - 1973w x 27d x 375h	£597	£609	£621	£633	£645	£657	£669	£597	£538
ESS18M... - 1773w x 27d x 375h	£559	£571	£583	£595	£607	£619	£631	£559	£507
ESS16M... - 1573w x 27d x 375h	£516	£528	£540	£552	£564	£576	£588	£516	£469
ESS15M... - 1473w x 27d x 375h	£485	£497	£509	£521	£533	£545	£557	£485	£451
ESS14M... - 1373w x 27d x 375h	£454	£466	£478	£490	£502	£514	£526	£454	£431
ESS12M... - 1173w x 27d x 375h	£422	£434	£446	£458	£470	£482	£494	£422	£382
ESS10M... - 973w x 27d x 375h	£385	£397	£409	£421	£433	£445	£457	£385	£348

Link Post

ELP375 - 4 Way	£72
-----------------------	-----

Linnea Desk Mounted Acoustic Screen for Single Desks

- Straight dividing screens faced with 6mm polyester fibre insulation board.
- Screen is bracketed to the outer edge of the desk top.
- Link post not required.
- Available as Hygiene Protection Screens and add-ons (see page 87-90).

• Class B certified in accordance with International Standards:

- ISO 354:2003
- ISO 11654:1997
- ISO 9613-1:1993



Straight Acoustic Screen

	Group 1	Group 2	Group 3	Group 4	Group 5	Group 6	Group 7
AESS20F - 1973w x 38d x 375h	£557	£569	£581	£593	£605	£617	£629
AESS18F - 1773w x 38d x 375h	£526	£538	£550	£562	£574	£586	£598
AESS16F - 1573w x 38d x 375h	£482	£494	£506	£518	£530	£542	£554
AESS15F - 1473w x 38d x 375h	£465	£477	£489	£501	£513	£525	£537
AESS14F - 1373w x 38d x 375h	£449	£461	£473	£485	£497	£509	£521
AESS12F - 1173w x 38d x 375h	£409	£421	£433	£445	£457	£469	£481
AESS10F - 973w x 38d x 375h	£386	£398	£410	£422	£434	£446	£458

Linnea Return System Screens for Single Desks

Lead Time: Standard (All products are manufactured to order and when 'Standard Lead Time' is quoted (7 – 10 days), this may vary dependant on volume ordered, factory capacity and distribution requirements at the time of ordering. For more information please contact your Dealer Business Manager or the Customer Services Team for clarification.)

Metalwork: Available in Anodised Silver (Standard), Black Graphite RAL 9004 and White RAL 9003

Fabric: Fully upholstered with pinnable surface available in Groups 1-7

Acrylic: Available in Blue, Green, Orange, Red, Frosted and Clear

MFC: Available in Ash, Autumn Cherry, Beech, Chester Oak, English Walnut, Grey, Grey Nebraska Oak, Laurentii Wenge, Natural Nebraska Oak and White

Linnea Desk Mounted Mid Return System Screen for Single Desks

- Straight dividing screens with aluminium trim and optional management rail.
- Screen is fixed to the link post at one end and uses a metal blade between the desk tops to fix its position.
- 4 way link post required (**ELP375**).
- Available as Hygiene Protection Screens and add-ons (**see page 87-90**).



System Screens



System Screens with Management Rail



ESSMR8F

- For Fabric, suffix **...F**
- For Acrylic, suffix **...A**
- For MFC without Management Rail, suffix **...MFC**
- For MFC with Management Rail, suffix **.../MFC**

Straight System Screen

	Group 1	Group 2	Group 3	Group 4	Group 5	Group 6	Group 7	Acrylic	MFC
ESSMR22... - 2173w x 27d x 375h	£455	£467	£479	£491	£503	£515	£527	£455	£411
ESSMR20... - 1973w x 27d x 375h	£444	£456	£468	£480	£492	£504	£516	£444	£401
ESSMR19... - 1873w x 27d x 375h	£434	£446	£458	£470	£482	£494	£506	£434	£392
ESSMR18... - 1773w x 27d x 375h	£419	£431	£443	£455	£467	£479	£491	£419	£382
ESSMR17... - 1673w x 27d x 375h	£404	£416	£428	£440	£452	£464	£476	£404	£366
ESSMR16... - 1573w x 27d x 375h	£385	£397	£409	£421	£433	£445	£457	£385	£351
ESSMR10... - 973w x 27d x 375h	£307	£319	£331	£343	£355	£367	£379	£307	£280
ESSMR8... - 773w x 27d x 375h	£295	£307	£319	£331	£343	£355	£367	£295	£263
ESSMR7... - 673w x 27d x 375h	£288	£300	£312	£324	£336	£348	£360	£288	£259
ESSMR6... - 573w x 27d x 375h	£282	£294	£306	£318	£330	£342	£354	£282	£251

Straight System Screen with Management Rail

ESSMR22M... - 2173w x 27d x 375h	£617	£629	£641	£653	£665	£677	£689	£617	£557
ESSMR20M... - 1973w x 27d x 375h	£597	£609	£621	£633	£645	£657	£669	£597	£538
ESSMR19M... - 1873w x 27d x 375h	£577	£589	£601	£613	£625	£637	£649	£577	£524
ESSMR18M... - 1773w x 27d x 375h	£559	£571	£583	£595	£607	£619	£631	£559	£507
ESSMR17M... - 1673w x 27d x 375h	£536	£548	£560	£572	£584	£596	£608	£536	£489
ESSMR16M... - 1573w x 27d x 375h	£516	£528	£540	£552	£564	£576	£588	£516	£469
ESSMR10M... - 973w x 27d x 375h	£385	£397	£409	£421	£433	£445	£457	£385	£348
ESSMR8M... - 773w x 27d x 375h	£371	£383	£395	£407	£419	£431	£443	£371	£331
ESSMR7M... - 673w x 27d x 375h	£364	£376	£388	£400	£412	£424	£436	£364	£323
ESSMR6M... - 573w x 27d x 375h	£357	£369	£381	£393	£405	£417	£429	£357	£317

Link Post

ELP375 - 4 Way	£72
-----------------------	-----

Linnea Return and Ped Return System Screens for Single Desks

Lead Time: Standard (All products are manufactured to order and when 'Standard Lead Time' is quoted (7 – 10 days), this may vary dependant on volume ordered, factory capacity and distribution requirements at the time of ordering. For more information please contact your Dealer Business Manager or the Customer Services Team for clarification.)

Metalwork: Available in Anodised Silver (Standard), Black Graphite RAL 9004 and White RAL 9003

Fabric: Fully upholstered with pinnable surface available in Groups 1-7

Acrylic: Available in Blue, Green, Orange, Red, Frosted and Clear

MFC: Available in Ash, Autumn Cherry, Beech, Chester Oak, English Walnut, Grey, Grey Nebraska Oak, Laurentii Wenge, Natural Nebraska Oak and White

Linnea Desk Mounted End Return System Screen for Single Desks

- Straight dividing screens with aluminium trim and optional management rail.
- Screen is fixed to the link post at one end and is bracketed to the desk tops at the other.
- 4 way link post required (ELP375). • Available as Hygiene Protection Screens and add-ons (see page 87-90).

- For Fabric, suffix ...F
- For Acrylic, suffix ...A
- For MFC without Management Rail, suffix ...MFC
- For MFC with Management Rail, suffix .../MFC



System Screens



System Screens with Management Rail



ESSER8F

Straight System Screen

	Group 1	Group 2	Group 3	Group 4	Group 5	Group 6	Group 7	Acrylic	MFC
ESSER22... - 2173w x 27d x 375h	£455	£467	£479	£491	£503	£515	£527	£455	£411
ESSER20... - 1973w x 27d x 375h	£444	£456	£468	£480	£492	£504	£516	£444	£401
ESSER19... - 1873w x 27d x 375h	£434	£446	£458	£470	£482	£494	£506	£434	£392
ESSER18... - 1773w x 27d x 375h	£419	£431	£443	£455	£467	£479	£491	£419	£382
ESSER17... - 1673w x 27d x 375h	£404	£416	£428	£440	£452	£464	£476	£404	£366
ESSER16... - 1573w x 27d x 375h	£385	£397	£409	£421	£433	£445	£457	£385	£351
ESSER10... - 973w x 27d x 375h	£307	£319	£331	£343	£355	£367	£379	£307	£280
ESSER8... - 773w x 27d x 375h	£295	£307	£319	£331	£343	£355	£367	£295	£263
ESSER7... - 673w x 27d x 375h	£288	£300	£312	£324	£336	£348	£360	£288	£259
ESSER6... - 573w x 27d x 375h	£282	£294	£306	£318	£330	£342	£354	£282	£251

Straight System Screen with Management Rail

ESSER22M... - 2173w x 27d x 375h	£617	£629	£641	£653	£665	£677	£689	£617	£557
ESSER20M... - 1973w x 27d x 375h	£597	£609	£621	£633	£645	£657	£669	£597	£538
ESSER19M... - 1873w x 27d x 375h	£577	£589	£601	£613	£625	£637	£649	£577	£524
ESSER18M... - 1773w x 27d x 375h	£559	£571	£583	£595	£607	£619	£631	£559	£507
ESSER17M... - 1673w x 27d x 375h	£536	£548	£560	£572	£584	£596	£608	£536	£489
ESSER16M... - 1573w x 27d x 375h	£516	£528	£540	£552	£564	£576	£588	£516	£469
ESSER10M... - 973w x 27d x 375h	£385	£397	£409	£421	£433	£445	£457	£385	£348
ESSER8M... - 773w x 27d x 375h	£371	£383	£395	£407	£419	£431	£443	£371	£331
ESSER7M... - 673w x 27d x 375h	£364	£376	£388	£400	£412	£424	£436	£364	£323
ESSER6M... - 573w x 27d x 375h	£357	£369	£381	£393	£405	£417	£429	£357	£317

Link Post

ELP375 - 4 Way | £72 |

Linnea Desk Mounted Ped Return System Screen for Single Desks

- Straight dividing screens with aluminium trim and optional management rail.
- Screen is fixed to the link post at one end and is bracketed to the desk tops at the other before the pedestal.
- 4 way link post required (ELP375).
- Available as Hygiene Protection Screens and add-ons (see page 87-90).

- For Fabric, suffix ...F
- For Acrylic, suffix ...A
- For MFC without Management Rail, suffix ...MFC
- For MFC with Management Rail, suffix .../MFC



System Screens



System Screens with Management Rail



ESSPR14F

Straight System Screen

	Group 1	Group 2	Group 3	Group 4	Group 5	Group 6	Group 7	Acrylic	MFC
ESSPR14... - 1392w x 27d x 375h	£357	£369	£381	£393	£405	£417	£429	£357	£324
ESSPR12... - 1192w x 27d x 375h	£325	£337	£349	£361	£373	£385	£397	£325	£295

Straight System Screen with Management Rail

ESSPR14M... - 1392w x 27d x 375h	£454	£466	£478	£490	£502	£514	£526	£454	£431
ESSPR12M... - 1192w x 27d x 375h	£422	£434	£446	£458	£470	£482	£494	£422	£382

Link Post

ELP375 - 4 Way | £72 |

Linnea 120 Degree System and Contract Screens

Lead Time: Standard (All products are manufactured to order and when 'Standard Lead Time' is quoted (7 – 10 days), this may vary dependant on volume ordered, factory capacity and distribution requirements at the time of ordering. For more information please contact your Dealer Business Manager or the Customer Services Team for clarification.)

Metalwork: Available in Anodised Silver (Standard), Black Graphite RAL 9004 and White RAL 9003

Fabric: Fully upholstered with pinnable surface available in Groups 1-7

Acrylic: Available in Blue, Green, Orange, Red, Frosted and Clear

MFC: Available in Ash, Autumn Cherry, Beech, Chester Oak, English Walnut, Grey, Grey Nebraska Oak, Laurentii Wenge, Natural Nebraska Oak and White

Linnea Desk Mounted System Screen for 120 Degree Workstations

- Straight dividing screens with aluminium trim and optional management rail.
- Screen is fixed to the link post at one end and is bracketed to the leg frame at the other end.
- 3 way link post required (ELP375/120). • Available as Hygiene Protection Screens and add-ons (see page 87-90).

- For Fabric, suffix ...F
- For Acrylic, suffix ...A
- For MFC without Management Rail, suffix ...MFC
- For MFC with Management Rail, suffix .../MFC



Straight System Screen

	Group 1	Group 2	Group 3	Group 4	Group 5	Group 6	Group 7	Acrylic	MFC
ELSS120/12... - 1179w x 27d x 375h	£325	£337	£349	£361	£373	£385	£397	£325	£295
ELSS120/10... - 979w x 27d x 375h	£307	£319	£331	£343	£355	£367	£379	£307	£280

Straight System Screen with Management Rail

ELSS120/12M... - 1179w x 27d x 375h	£422	£434	£446	£458	£470	£482	£494	£422	£382
ELSS120/10M... - 979w x 27d x 375h	£385	£397	£409	£421	£433	£445	£457	£385	£348

Link Post

ELP375/120 - 3 Way	£72
---------------------------	-----

Linnea Desk Mounted Contract Screen for Single Desks

- Straight dividing screens with pinnable or non-pinnable fully upholstered surface.
- Pullover style fabric application.
- Screen is bracketed to the outer edge of the desk top.
- Link post not required.
- Available as Hygiene Protection Screens and add-ons (see page 87-90).

- For Back to Back Desking, use standard code
- For Stand Alone Desking, suffix .../X



Straight Pinnable Contract Screen

	Group 1	Group 2	Group 3	Group 4	Group 5	Group 6	Group 7
EPCS20FP - 1973w x 38d x 375h	£281	£293	£305	£317	£329	£341	£353
EPCS18FP - 1773w x 38d x 375h	£270	£282	£294	£306	£318	£330	£342
EPCS16FP - 1573w x 38d x 375h	£261	£273	£285	£297	£309	£321	£333
EPCS15FP - 1473w x 38d x 375h	£255	£267	£279	£291	£303	£315	£327
EPCS14FP - 1373w x 38d x 375h	£248	£260	£272	£284	£296	£308	£320
EPCS12FP - 1173w x 38d x 375h	£236	£248	£260	£272	£284	£296	£308
EPCS10FP - 973w x 38d x 375h	£223	£235	£247	£259	£271	£283	£295

Straight Contract Screen

EPCS20F - 1973w x 25d x 375h	£257	£269	£281	£293	£305	£317	£329
EPCS18F - 1773w x 25d x 375h	£245	£257	£269	£281	£293	£305	£317
EPCS16F - 1573w x 25d x 375h	£236	£248	£260	£272	£284	£296	£308
EPCS15F - 1473w x 25d x 375h	£231	£243	£255	£267	£279	£291	£303
EPCS14F - 1373w x 25d x 375h	£225	£237	£249	£261	£273	£285	£297
EPCS12F - 1173w x 25d x 375h	£211	£223	£235	£247	£259	£271	£283
EPCS10F - 973w x 25d x 375h	£199	£211	£223	£235	£247	£259	£271

Linnea Acrylic Hygiene Protection Screens for Double Benches

Lead Time: Standard (All products are manufactured to order and when 'Standard Lead Time' is quoted (7 – 10 days), this may vary dependant on volume ordered, factory capacity and distribution requirements at the time of ordering. For more information please contact your Dealer Business Manager or the Customer Services Team for clarification.)

Acrylic: Clear

Metalwork: Fixing Brackets and Freestanding Feet supplied in Silver RAL 9006 (Standard) - Optional Black Graphite RAL 9004 and White RAL 9003



Acrylic Illustrated in Blue



ELHPS16
Acrylic Illustrated in Blue



Linnea Desk Mounted Acrylic Hygiene Protection Screen for Double Benches

- The workstation top must be removed in order to fix this bracket to the desktop.
- Rectangular acrylic dividing screens supplied with fixing brackets.
- Screen is fixed to the desktop.
- Brackets supplied in Silver RAL 9006 as standard.

Linnea Desk Mounted Screen

	Price
ELHPS20 - 1973w x 5d x 700h	£367
ELHPS18 - 1773w x 5d x 700h	£342
ELHPS16 - 1573w x 5d x 700h	£316
ELHPS15 - 1473w x 5d x 700h	£306
ELHPS14 - 1373w x 5d x 700h	£294
ELHPS12 - 1173w x 5d x 700h	£265
ELHPS10 - 973w x 5d x 700h	£238



EHPSMR8
Acrylic Illustrated in Blue



Linnea Desk Mounted Mid Return Acrylic Hygiene Protection Screen for Double Benches

- The workstation top must be removed in order to fix this bracket to the desktop.
- Rectangular acrylic dividing screens supplied with 1x freestanding foot and 1x fixing bracket.
- Screen is clamped to the desktop.
- Freestanding feet and brackets supplied in Silver RAL 9006 as standard.

Linnea Desk Mounted Mid Return Screen

	Price
EHPSMR8 - 780w x 5d x 700h	£248
EHPSMR7 - 680w x 5d x 700h	£235
EHPSMR6 - 580w x 5d x 700h	£222



EHPSER8
Acrylic Illustrated in Blue



Linnea Desk Mounted End Return Acrylic Hygiene Protection Screen for Double Benches

- The workstation top must be removed in order to fix this bracket to the desk top
- Rectangular acrylic dividing screens supplied with fixing brackets.
- Screen is clamped to the desktop.
- Brackets supplied in Silver RAL 9006 as standard.

Linnea Desk Mounted End Return Screen

	Price
EHPSER8 - 780w x 5d x 700h	£248
EHPSER7 - 680w x 5d x 700h	£235
EHPSER6 - 580w x 5d x 700h	£222

Linnea Acrylic Hygiene Protection Screens for Double Benches

Lead Time: Standard (All products are manufactured to order and when 'Standard Lead Time' is quoted (7 – 10 days), this may vary dependant on volume ordered, factory capacity and distribution requirements at the time of ordering. For more information please contact your Dealer Business Manager or the Customer Services Team for clarification.)

Acrylic: Clear

Metalwork: Fixing Brackets supplied in Silver RAL 9006 (Standard) - Optional Black Graphite RAL 9004 and White RAL 9003



ELSS16/HPS
Acrylic Illustrated in Blue



Linnea Desk Mounted Acrylic Hygiene Protection Screen for Double Benches with Screens

- Rectangular acrylic dividing screens supplied with brackets.
- Screen is bracketed to the existing screen frame.
- Brackets supplied in Silver RAL 9006 as standard.
- Screens compatible with Non-Elite Desk Mounted Screens available.

Addition for 27mm Linnea Desk Mounted System Screen

	Price
ELSS20/HPS - 1973w x 5d x 325h	£224
ELSS18/HPS - 1773w x 5d x 325h	£212
ELSS16/HPS - 1573w x 5d x 325h	£199
ELSS15/HPS - 1473w x 5d x 325h	£194
ELSS14/HPS - 1373w x 5d x 325h	£189
ELSS12/HPS - 1173w x 5d x 325h	£171
ELSS10/HPS - 973w x 5d x 325h	£158

Addition for 38mm Linnea Desk Mounted Acoustic Screen

AELSS20F/HPS - 1973w x 5d x 325h	£224
AELSS18F/HPS - 1773w x 5d x 325h	£212
AELSS16F/HPS - 1573w x 5d x 325h	£199
AELSS15F/HPS - 1473w x 5d x 325h	£194
AELSS14F/HPS - 1373w x 5d x 325h	£189
AELSS12F/HPS - 1173w x 5d x 325h	£171
AELSS10F/HPS - 973w x 5d x 325h	£158

Addition for 38mm Linnea Desk Mounted Contract Screen (Pinnable)

ELPCS20FP/HPS - 1973w x 5d x 325h	£224
ELPCS18FP/HPS - 1773w x 5d x 325h	£212
ELPCS16FP/HPS - 1573w x 5d x 325h	£199
ELPCS15FP/HPS - 1473w x 5d x 325h	£194
ELPCS14FP/HPS - 1373w x 5d x 325h	£189
ELPCS12FP/HPS - 1173w x 5d x 325h	£171
ELPCS10FP/HPS - 973w x 5d x 325h	£158

Addition for 27mm Linnea Desk Mounted Contract Screen (Non-Pinnable)

ELPCS20F/HPS - 1973w x 5d x 325h	£224
ELPCS18F/HPS - 1773w x 5d x 325h	£212
ELPCS16F/HPS - 1573w x 5d x 325h	£199
ELPCS15F/HPS - 1473w x 5d x 325h	£194
ELPCS14F/HPS - 1373w x 5d x 325h	£189
ELPCS12F/HPS - 1173w x 5d x 325h	£171
ELPCS10F/HPS - 973w x 5d x 325h	£158



Linnea Acrylic Hygiene Protection Screens for Single Desks

Lead Time: Standard (All products are manufactured to order and when 'Standard Lead Time' is quoted (7 – 10 days), this may vary dependant on volume ordered, factory capacity and distribution requirements at the time of ordering. For more information please contact your Dealer Business Manager or the Customer Services Team for clarification.)

Acrylic: Clear

Metalwork: Fixing Brackets supplied in Silver RAL 9006 (Standard) - Optional Black Graphite RAL 9004 and White RAL 9003



EHPS16
Acrylic Illustrated in Blue



EHPS16/O
Acrylic Illustrated
in Blue



Linnea Desk Mounted Acrylic Hygiene Protection Screen for Single Desks

- Rectangular acrylic dividing screens supplied with fixing brackets.
- Screen is clamped to the desktop.
- Brackets supplied in Silver RAL 9006 as standard.
- For a central opening of 400w x 60h, suffix .../O.

Linnea Desk Mounted Screen

	Price
EHPS20 - 1973w x 5d x 700h	£367
EHPS18 - 1773w x 5d x 700h	£342
EHPS16 - 1573w x 5d x 700h	£316
EHPS15 - 1473w x 5d x 700h	£306
EHPS14 - 1373w x 5d x 700h	£294
EHPS12 - 1173w x 5d x 700h	£265
EHPS10 - 973w x 5d x 700h	£238



ESS16/HPS
Acrylic Illustrated in Blue



Linnea Desk Mounted Acrylic Hygiene Protection Screen for Single Desks with Screens

- Rectangular acrylic dividing screens supplied with brackets.
- Screen is bracketed to the existing screen frame.
- Brackets supplied in Silver RAL 9006 as standard.
- Screens compatible with Non-Elite Desk Mounted Screens available.

Addition for 27mm Linnea Desk Mounted System Screen

	Price
ESS20/HPS - 1973w x 5d x 325h	£224
ESS18/HPS - 1773w x 5d x 325h	£212
ESS16/HPS - 1573w x 5d x 325h	£199
ESS15/HPS - 1473w x 5d x 325h	£194
ESS14/HPS - 1373w x 5d x 325h	£189
ESS12/HPS - 1173w x 5d x 325h	£171
ESS10/HPS - 973w x 5d x 325h	£158

Addition for 38mm Linnea Desk Mounted Acoustic Screen

AESS20F/HPS - 1973w x 5d x 325h	£224
AESS18F/HPS - 1773w x 5d x 325h	£212
AESS16F/HPS - 1573w x 5d x 325h	£199
AESS15F/HPS - 1473w x 5d x 325h	£194
AESS14F/HPS - 1373w x 5d x 325h	£189
AESS12F/HPS - 1173w x 5d x 325h	£171
AESS10F/HPS - 973w x 5d x 325h	£158

Addition for 38mm Linnea Desk Mounted Contract Screen (Pinnable)

EPCS20FP/HPS - 1973w x 5d x 325h	£224
EPCS18FP/HPS - 1773w x 5d x 325h	£212
EPCS16FP/HPS - 1573w x 5d x 325h	£199
EPCS15FP/HPS - 1473w x 5d x 325h	£194
EPCS14FP/HPS - 1373w x 5d x 325h	£189
EPCS12FP/HPS - 1173w x 5d x 325h	£171
EPCS10FP/HPS - 973w x 5d x 325h	£158

Addition for 27mm Linnea Desk Mounted Contract Screen (Non-Pinnable)

EPCS20F/HPS - 1973w x 5d x 325h	£224
EPCS18F/HPS - 1773w x 5d x 325h	£212
EPCS16F/HPS - 1573w x 5d x 325h	£199
EPCS15F/HPS - 1473w x 5d x 325h	£194
EPCS14F/HPS - 1373w x 5d x 325h	£189
EPCS12F/HPS - 1173w x 5d x 325h	£171
EPCS10F/HPS - 973w x 5d x 325h	£158

Linnea Acrylic Hygiene Protection Screens for Single Desks and 120 Degree Workstations

Lead Time: Standard (All products are manufactured to order and when 'Standard Lead Time' is quoted (7 – 10 days), this may vary dependant on volume ordered, factory capacity and distribution requirements at the time of ordering. For more information please contact your Dealer Business Manager or the Customer Services Team for clarification.)

Acrylic: Clear

Metalwork: Fixing Brackets and Freestanding Feet supplied in Silver RAL 9006 (Standard) - Optional Black Graphite RAL 9004 and White RAL 9003



EHPSMR8
Acrylic Illustrated in Blue



Linnea Desk Mounted Mid Return Acrylic Hygiene Protection Screen for Single Desks

- Rectangular acrylic dividing screens supplied with 1x freestanding foot and 1x fixing bracket.
- Screen is clamped to the desktop.
- Freestanding feet and brackets supplied in Silver RAL 9006 as standard.

Linnea Desk Mounted Mid Return Screen

		Price
EHPSMR10	- 980w x 5d x 700h	£260
EHPSMR8	- 780w x 5d x 700h	£248
EHPSMR7	- 680w x 5d x 700h	£235
EHPSMR6	- 580w x 5d x 700h	£222



EHPSER8
Acrylic Illustrated in Blue



Linnea Desk Mounted End Return Acrylic Hygiene Protection Screen for Single Desks

- The workstation top must be removed in order to fix this bracket to the desktop.
- Rectangular acrylic dividing screens supplied with fixing brackets.
- Screen is clamped to the desktop.
- Brackets supplied in Silver RAL 9006 as standard.

Linnea Desk Mounted End Return Screen

		Price
EHPSER10	- 980w x 5d x 700h	£260
EHPSER8	- 780w x 5d x 700h	£248
EHPSER7	- 680w x 5d x 700h	£235
EHPSER6	- 580w x 5d x 700h	£222



ELSS120/12/HPS
Acrylic Illustrated in Blue



Linnea Desk Mounted Acrylic Hygiene Protection Screen for 120 Degree Workstations with Screens

- Rectangular acrylic dividing screens supplied with brackets.
- Screen is bracketed to the existing screen frame.
- Brackets supplied in Silver RAL 9006 as standard.
- Screens compatible with Non-Elite Desk Mounted Screens available.

Addition for 27mm Linnea Desk Mounted System Screen

		Price
ELSS120/12/HPS	- 1179w x 5d x 325h	£184
ELSS120/10/HPS	- 979w x 5d x 325h	£163

Matrix Height Settable and Fixed Height Workstations



Shared legs are a feature of the Matrix range, minimising the number of legs required and increasing the useable space, under the workstation. Included in the range is a height settable workstation offering height adjustment from 650mm to 850mm. The height is adjusted by unscrewing a single fixing in each leg upright and sliding the lower section of the telescopic leg to the desired height, using the marked height labels. The workstations are complemented by height settable screen panels, allowing the user to determine the height of the screen, irrespective of the workstation height setting. For an executive, clean appearance, optional horizontal cable trays and vertical cable risers ensure cables are routed within the workstation, from the entry point of the leg to the underside of the desk.

Matrix Height Settable Workstations and Returns

Lead Time: Standard (All products are manufactured to order and when 'Standard Lead Time' is quoted (7 – 10 days), this may vary dependant on volume ordered, factory capacity and distribution requirements at the time of ordering. For more information please contact your Dealer Business Manager or the Customer Services Team for clarification.)

Wood: Available in MFC (Ash, Autumn Cherry, Beech, Chester Oak, English Walnut, Grey, Grey Nebraska Oak, Laurentii Wenge, Natural Nebraska Oak and White)
Top Panel Edge Detail available on 25mm White MFC (Wenge and Black - Add £32 Retail Per Top) (Plywood - Add £42 Retail Per Top)

Metalwork: Available in Silver RAL 9006 (Standard), Black Graphite RAL 9004, White RAL 9003, Chrome Effect (Add 15%) and Raw finish (Add 5%)



AR16/8

Matrix Height Settable Rectangular Desk

- 25mm top panel.
- Sit / sit height adjustment of 650mm-850mm via single leg fixing.

Model	Dimensions	MFC Price
AR20/10	2000w x 1000d x 650-850h	£725
AR18/10	1800w x 1000d x 650-850h	£708
AR16/10	1600w x 1000d x 650-850h	£696
AR14/10	1400w x 1000d x 650-850h	£687
AR12/10	1200w x 1000d x 650-850h	£672
AR20/8	2000w x 800d x 650-850h	£709
AR18/8	1800w x 800d x 650-850h	£699
AR16/8	1600w x 800d x 650-850h	£688
AR14/8	1400w x 800d x 650-850h	£670
AR12/8	1200w x 800d x 650-850h	£659
AR10/8	1000w x 800d x 650-850h	£644
AR20/6	2000w x 600d x 650-850h	£701
AR18/6	1800w x 600d x 650-850h	£690
AR16/6	1600w x 600d x 650-850h	£677
AR14/6	1400w x 600d x 650-850h	£667
AR12/6	1200w x 600d x 650-850h	£656
AR10/6	1000w x 600d x 650-850h	£643



A16/10/8RH

Matrix Height Settable Angular Workstation

- 25mm top panel.
- Sit / sit height adjustment of 650mm-850mm via single leg fixing.
- 600mm return.

Model	Dimensions	MFC Price
A20/10/8LH	2000w x 1000-800d x 650-850h	£770
A20/10/8RH	2000w x 1000-800d x 650-850h	£770
A18/10/8LH	1800w x 1000-800d x 650-850h	£762
A18/10/8RH	1800w x 1000-800d x 650-850h	£762
A16/10/8LH	1600w x 1000-800d x 650-850h	£744
A16/10/8RH	1600w x 1000-800d x 650-850h	£744
A14/10/8LH	1400w x 1000-800d x 650-850h	£732
A14/10/8RH	1400w x 1000-800d x 650-850h	£732
A20/8/6LH	2000w x 800-600d x 650-850h	£763
A20/8/6RH	2000w x 800-600d x 650-850h	£763
A18/8/6LH	1800w x 800-600d x 650-850h	£745
A18/8/6RH	1800w x 800-600d x 650-850h	£745
A16/8/6LH	1600w x 800-600d x 650-850h	£732
A16/8/6RH	1600w x 800-600d x 650-850h	£732
A14/8/6LH	1400w x 800-600d x 650-850h	£723
A14/8/6RH	1400w x 800-600d x 650-850h	£723



AC120

Matrix Height Settable 120 Degree Workstation

- 25mm top panel.
- Sit / sit height adjustment of 650mm-850mm via single leg fixing.
- Can be configured as a singular workstation or in modules of 3, 6, 9 etc.

Model	Dimensions	MFC Price
AC120	2078w (extreme) x 800d x 650-850h	£947
AC120/6	1732w (extreme) x 600d x 650-850h	£890



ASR10/6RH

Matrix Height Settable Secretarial Return

- 25mm top panel.
- Sit / sit height adjustment of 650mm-850mm via single leg fixing.

Model	Dimensions	MFC Price
ASR12/6LH...	1200w x 600d x 650-850h	£464
ASR12/6RH...	1200w x 600d x 650-850h	£464
ASR10/6LH...	1000w x 600d x 650-850h	£443
ASR10/6RH...	1000w x 600d x 650-850h	£443

- For Rectangular Desking, use standard code
- For Angular Workstations, suffix .../X

Matrix Fixed Height Workstations

Lead Time: Standard (All products are manufactured to order and when 'Standard Lead Time' is quoted (7 – 10 days), this may vary dependant on volume ordered, factory capacity and distribution requirements at the time of ordering. For more information please contact your Dealer Business Manager or the Customer Services Team for clarification.)

Wood: Available in MFC (Ash, Autumn Cherry, Beech, Chester Oak, English Walnut, Grey, Grey Nebraska Oak, Laurentii Wenge, Natural Nebraska Oak and White)
Top Panel Edge Detail available on 25mm White MFC (Wenge and Black - Add £32 Retail Per Top) (Plywood - Add £42 Retail Per Top)

Metalwork: Available in Silver RAL 9006 (Standard), Black Graphite RAL 9004, White RAL 9003, Chrome Effect (Add 15%) and Raw finish (Add 5%)



M16/16

Matrix Double Bench

- 25mm top panel. • 7mm gap between the worktops. • Horizontal cable tray not supplied.
- 640h mobile pedestals will protrude with 1400d and 1200d double benches, as an alternative, use MPF and MP3 pedestals (see page 226).

	MFC
M20/16 - 2000w x 1600d x 740h	£822
M18/16 - 1800w x 1600d x 740h	£806
M16/16 - 1600w x 1600d x 740h	£792
M14/16 - 1400w x 1600d x 740h	£785
M12/16 - 1200w x 1600d x 740h	£778
M10/16 - 1000w x 1600d x 740h	£771
M20/14 - 2000w x 1400d x 740h	£803
M18/14 - 1800w x 1400d x 740h	£789
M16/14 - 1600w x 1400d x 740h	£774
M14/14 - 1400w x 1400d x 740h	£767
M12/14 - 1200w x 1400d x 740h	£761
M10/14 - 1000w x 1400d x 740h	£753
M20/12 - 2000w x 1200d x 740h	£785
M18/12 - 1800w x 1200d x 740h	£771
M16/12 - 1600w x 1200d x 740h	£755
M14/12 - 1400w x 1200d x 740h	£747
M12/12 - 1200w x 1200d x 740h	£742
M10/12 - 1000w x 1200d x 740h	£735



M16/16/INT

Matrix Double Bench with Shared Inset Leg

- 25mm top panel. • 7mm gap between the worktops. • Horizontal cable tray not supplied.
- 640h mobile pedestals will protrude with 1400d and 1200d double benches, as an alternative, use MPF and MP3 pedestals (see page 226).

	MFC
M20/16/INT - 2000w x 1600d x 740h	£785
M18/16/INT - 1800w x 1600d x 740h	£771
M16/16/INT - 1600w x 1600d x 740h	£755
M14/16/INT - 1400w x 1600d x 740h	£747
M12/16/INT - 1200w x 1600d x 740h	£742
M10/16/INT - 1000w x 1600d x 740h	£735
M20/14/INT - 2000w x 1400d x 740h	£767
M18/14/INT - 1800w x 1400d x 740h	£748
M16/14/INT - 1600w x 1400d x 740h	£738
M14/14/INT - 1400w x 1400d x 740h	£732
M12/14/INT - 1200w x 1400d x 740h	£725
M10/14/INT - 1000w x 1400d x 740h	£714
M20/12/INT - 2000w x 1200d x 740h	£747
M18/12/INT - 1800w x 1200d x 740h	£728
M16/12/INT - 1600w x 1200d x 740h	£722
M14/12/INT - 1400w x 1200d x 740h	£712
M12/12/INT - 1200w x 1200d x 740h	£705
M10/12/INT - 1000w x 1200d x 740h	£697



Matrix Workstations

Lead Time: Standard (All products are manufactured to order and when 'Standard Lead Time' is quoted (7 – 10 days), this may vary dependant on volume ordered, factory capacity and distribution requirements at the time of ordering. For more information please contact your Dealer Business Manager or the Customer Services Team for clarification.)

Wood: Available in MFC (Ash, Autumn Cherry, Beech, Chester Oak, English Walnut, Grey, Grey Nebraska Oak, Laurentii Wenge, Natural Nebraska Oak and White)
Top Panel Edge Detail available on 25mm White MFC (Wenge and Black - Add £32 Retail Per Top) (Plywood - Add £42 Retail Per Top)

Metalwork: Available in Silver RAL 9006 (Standard), Black Graphite RAL 9004, White RAL 9003, Chrome Effect (Add 15%) and Raw finish (Add 5%)



MR16/8

Matrix Rectangular Desk

- 25mm top panel. • Horizontal cable tray not supplied.

	MFC
MR20/8 - 2000w x 800d x 740h	£557
MR18/8 - 1800w x 800d x 740h	£546
MR16/8 - 1600w x 800d x 740h	£540
MR14/8 - 1400w x 800d x 740h	£532
MR12/8 - 1200w x 800d x 740h	£526
MR10/8 - 1000w x 800d x 740h	£518
MR20/7 - 2000w x 700d x 740h	£550
MR18/7 - 1800w x 700d x 740h	£543
MR16/7 - 1600w x 700d x 740h	£536
MR14/7 - 1400w x 700d x 740h	£530
MR12/7 - 1200w x 700d x 740h	£523
MR10/7 - 1000w x 700d x 740h	£516
MR20/6 - 2000w x 600d x 740h	£546
MR18/6 - 1800w x 600d x 740h	£540
MR16/6 - 1600w x 600d x 740h	£532
MR14/6 - 1400w x 600d x 740h	£526
MR12/6 - 1200w x 600d x 740h	£518
MR10/6 - 1000w x 600d x 740h	£512



MR16/8/INT

Matrix Rectangular Desk with Shared Inset Leg

- 25mm top panel. • Horizontal cable tray not supplied.

	MFC
MR20/8/INT - 2000w x 800d x 740h	£518
MR18/8/INT - 1800w x 800d x 740h	£512
MR16/8/INT - 1600w x 800d x 740h	£505
MR14/8/INT - 1400w x 800d x 740h	£499
MR12/8/INT - 1200w x 800d x 740h	£489
MR10/8/INT - 1000w x 800d x 740h	£482



M16/10/8RH

Matrix Angular Workstation

- 25mm top panel. • Horizontal cable tray not supplied.

	MFC
M20/10/8LH - 2000w x 1000-800d x 740h	£593
M20/10/8RH - 2000w x 1000-800d x 740h	£593
M18/10/8LH - 1800w x 1000-800d x 740h	£585
M18/10/8RH - 1800w x 1000-800d x 740h	£585
M16/10/8LH - 1600w x 1000-800d x 740h	£573
M16/10/8RH - 1600w x 1000-800d x 740h	£573
M14/10/8LH - 1400w x 1000-800d x 740h	£564
M14/10/8RH - 1400w x 1000-800d x 740h	£564
M20/8/6LH - 2000w x 800-600d x 740h	£585
M20/8/6RH - 2000w x 800-600d x 740h	£585
M18/8/6LH - 1800w x 800-600d x 740h	£578
M18/8/6RH - 1800w x 800-600d x 740h	£578
M16/8/6LH - 1600w x 800-600d x 740h	£566
M16/8/6RH - 1600w x 800-600d x 740h	£566
M14/8/6LH - 1400w x 800-600d x 740h	£558
M14/8/6RH - 1400w x 800-600d x 740h	£558

Matrix Workstations, Returns and Extensions

Lead Time: Standard (All products are manufactured to order and when 'Standard Lead Time' is quoted (7 – 10 days), this may vary dependant on volume ordered, factory capacity and distribution requirements at the time of ordering. For more information please contact your Dealer Business Manager or the Customer Services Team for clarification.)

Wood: Available in MFC (Ash, Autumn Cherry, Beech, Chester Oak, English Walnut, Grey, Grey Nebraska Oak, Laurentii Wenge, Natural Nebraska Oak and White)
Top Panel Edge Detail available on 25mm White MFC (Wenge and Black - Add £32 Retail Per Top) (Plywood - Add £42 Retail Per Top)

Metalwork: Available in Silver RAL 9006 (Standard), Black Graphite RAL 9004, White RAL 9003, Chrome Effect (Add 15%) and Raw finish (Add 5%)



MMA16/16RH

Matrix Managers Workstation

- 2x 25mm top panels. • Horizontal cable tray not supplied.

	MFC
MMA18/18LH - 1800w x 1800d x 740h	£878
MMA18/18RH - 1800w x 1800d x 740h	£878
MMA16/18LH - 1600w x 1800d x 740h	£867
MMA16/18RH - 1600w x 1800d x 740h	£867
MMA18/16LH - 1800w x 1600d x 740h	£865
MMA18/16RH - 1800w x 1600d x 740h	£865
MMA16/16LH - 1600w x 1600d x 740h	£856
MMA16/16RH - 1600w x 1600d x 740h	£856



M120/12/8

Matrix 120 Degree Workstation

- 25mm top panel. • Horizontal cable tray not supplied.
- Can be configured as a single workstation or in modules of 3, 6, 9, etc.

	MFC
M120/12/8 - 2078w (extreme) x 800d x 740h	£774
M120/12/6 - 2078w (extreme) x 600d x 740h	£723
M120/10/6 - 1732w (extreme) x 600d x 740h	£681



M120/12/8/INT

Matrix 120 Degree Workstation with Shared Intermediate Leg

- 25mm top panel. • Horizontal cable tray not supplied.
- Can be a single workstation or configured as a 3, 6, 9, etc, person module.
- Must be configured alongside M120/12/8.

	MFC
M120/12/8/INT - 2078w (extreme) x 800d x 740h	£736



MSR10/6RH

Matrix Secretarial Return

- 25mm top panel. • Horizontal cable tray not supplied.

	MFC
MSR10/6LH... - 1000w x 600d x 740h	£363
MSR10/6RH... - 1000w x 600d x 740h	£363

- For Rectangular Desking, use standard code
- For Angular Workstations, suffix **.../X**
- For Double Bench Workstations without Screens, suffix **.../B**
- For Double Bench Workstations with Screens, suffix **.../BS**



MSME16/6

Matrix Straight Extension

- 25mm top panel.

For No Screens and All 120 Degree Clusters

	MFC
MSME16/6 - For 1600d Ends - 1600w x 650d x 740h	£482
MSME14/5 - For 1400d Ends - 1400w x 500d x 740h	£473
MSME12/5 - For 1200d Ends - 1200w x 500d x 740h	£461

For Contract or System Screens

MSME16/6/S - For 1600d Ends - 1634w x 650d x 740h	£482
MSME14/5/S - For 1400d Ends - 1434w x 500d x 740h	£473
MSME12/5/S - For 1200d Ends - 1234w x 500d x 740h	£461

For Acoustic Screens

MSME16/6/A - For 1600d Ends - 1645w x 650d x 740h	£482
MSME14/5/A - For 1400d Ends - 1445w x 500d x 740h	£473
MSME12/5/A - For 1200d Ends - 1245w x 500d x 740h	£461



MSME16/6/S

Matrix Accessories

Lead Time: Standard (All products are manufactured to order and when 'Standard Lead Time' is quoted (7 – 10 days), this may vary dependant on volume ordered, factory capacity and distribution requirements at the time of ordering. For more information please contact your Dealer Business Manager or the Customer Services Team for clarification.)

Wood: Available in MFC (Ash, Autumn Cherry, Beech, Chester Oak, English Walnut, Grey, Grey Nebraska Oak, Laurentii Wenge, Natural Nebraska Oak and White)

Metalwork: Available in Silver RAL 9006 (Standard), Black Graphite RAL 9004, White RAL 9003, Chrome Effect (Add 15%) and Raw finish (Add 5%)



MDDSE16

Matrix Decorative Slab End and Leg Frame for Fixed Height Workstations

- Designed to cover the ends of Matrix runs of desks. • Can be retrofitted.
- For use on one end of the workstation (for use on both ends, specify 2x slab ends).

MFC

MDDSE16 - For 1600d Ends	_____	£317
MDDSE14 - For 1400d Ends	_____	£306
MDDSE12 - For 1200d Ends	_____	£296
MSDSE10 - For 1000d Ends	_____	£284
MSDSE08 - For 800d Ends	_____	£277
MSDSE07 - For 700d Ends	_____	£275
MSDSE06 - For 600d Ends	_____	£269



MRMP16

Matrix MFC Modesty Panel

- Modesty panels are 300mm high and 18mm deep.

MFC

MRMP20 - For 2000w Workstations	- 1700w	_____	£119
MRMP18 - For 1800w Workstations	- 1500w	_____	£116
MRMP16 - For 1600w Workstations	- 1300w	_____	£113
MRMP14 - For 1400w Workstations	- 1100w	_____	£108
MRMP12 - For 1200w Workstations	- 900w	_____	£104
MRMP10 - For 1000w Workstations	- 700w	_____	£99



ARMP16
Illustrated in red

Matrix Steel Modesty Panel

- Modesty panels are 290mm high.

Metalwork

ARMP20 - For 2000w Workstations	- 1700w	_____	£176
ARMP18 - For 1800w Workstations	- 1500w	_____	£170
ARMP16 - For 1600w Workstations	- 1300w	_____	£167
ARMP14 - For 1400w Workstations	- 1100w	_____	£163
ARMP12 - For 1200w Workstations	- 900w	_____	£161
ARMP10 - For 1000w Workstations	- 700w	_____	£155



MA7D
Illustrated in red

Matrix Cable Tray for Double Benches

- High capacity cable management system neatly conceals power, data and telecom cables through a hinged cable management tray. • Cable trays are 222mm deep and 92mm high.

Metalwork

MA10D - For 2000w Workstations	- 1700w	_____	£151
MA9D - For 1800w Workstations	- 1500w	_____	£133
MA7D - For 1600w Workstations	- 1300w	_____	£119
MA5D - For 1400w Workstations	- 1100w	_____	£101
MA3D - For 1200w Workstations	- 900w	_____	£92
MA2D - For 1000w Workstations	- 700w	_____	£76



MA7
Illustrated in red

Matrix Cable Tray for Single Workstations

- Tray can be positioned to the users side of the workstation or towards the rear.
- Cable trays are 100mm deep and 110mm high.

Metalwork

MA10 - For 2000w Workstations	- 1600w	_____	£72
MA9 - For 1800w Workstations	- 1400w	_____	£67
MA7 - For 1600w Workstations	- 1200w	_____	£57
MA5 - For 1400w Workstations	- 1000w	_____	£55
MA3 - For 1200w Workstations and 1200w 120 Degree Clusters	- 800w	_____	£52
MA2 - For 1000w Workstations and 1000w 120 Degree Clusters	- 600w	_____	£46
MA12 - For Managers Workstations with 1800d Return	- 1300w	_____	£67
MA11 - For Managers Workstations with 1600d Return	- 1100w	_____	£57

Matrix Accessories

Lead Time: Standard (All products are manufactured to order and when 'Standard Lead Time' is quoted (7 – 10 days), this may vary dependant on volume ordered, factory capacity and distribution requirements at the time of ordering. For more information please contact your Dealer Business Manager or the Customer Services Team for clarification.)

Metalwork: Available in Silver RAL 9006 (Standard), Black Graphite RAL 9004, White RAL 9003, Chrome Effect (Add 15%) and Raw finish (Add 5%)



ALCR
Illustrated in red

Matrix Cable Risers

- Single channel cable riser (2 per pack).

	Metalwork
ALCR - For Height Settable Workstations	£43
MLCR - For Fixed Height Workstations	£38



MBCPU/W and MBCPU

Matrix CPU Holder

- Includes Matrix mounting kit.
- Adjustable CPU holder for PC towers.
- Rotates a full 360 degrees for complete access to cables and ports.

	Price
MBCPU - Black Trim	£186
MBCPU/W - White Trim	£186



2LM2BS

Showing Bolt Through Version

M2 Monitor Arm

- Post mounted monitor arm with spring assisted tension.

	Price
2LM2CS/TFC - Silver Clamp on Desk Fixing	£304
2LM2CW/TFC - White Clamp on Desk Fixing	£304

• Spring Assisted Tension Height Adjustment



F2LMPBT

Showing Bolt Through Version

Flex Monitor Arm

- Post mounted monitor arm with 2x folding links.

	Price
F2LMP - Silver Clamp on Desk Fixing	£180
F2LMP/W - White Clamp on Desk Fixing	£180
F2LGP - Silver Clamp on Desk Fixing	£227
F2LGP/W - White Clamp on Desk Fixing	£227

• Manual Post Height Adjustment

• Front End Height Adjustment



SCR/S - SCR/B - SCR/W

Slinky Cable Riser

- Suitable for all desking ranges.

	Price
SCR/S - Silver	£59
SCR/B - Black	£59
SCR/W - White	£59

Matrix Conference / Meeting Tables

Lead Time: Standard (All products are manufactured to order and when 'Standard Lead Time' is quoted (7 – 10 days), this may vary dependant on volume ordered, factory capacity and distribution requirements at the time of ordering. For more information please contact your Dealer Business Manager or the Customer Services Team for clarification.)

Wood: Available in MFC (Ash, Autumn Cherry, Beech, Chester Oak, English Walnut, Grey, Grey Nebraska Oak, Laurentii Wenge, Natural Nebraska Oak and White)
Top Panel Edge Detail available on 25mm White MFC (Wenge and Black - Add £32 Retail Per Top) (Plywood - Add £42 Retail Per Top)

Metalwork: Available in Silver RAL 9006 (Standard), Black Graphite RAL 9004, White RAL 9003, Chrome Effect (Add 15%) and Raw finish (Add 5%)
Also available in Blue RAL 5001, Coral RAL 2001, Green RAL 6016, Light Grey RAL 7038, Teal RAL 5018 and Yellow RAL 1021 (Add 12% for all - 2 Week Lead Time)



AMT16/10

Matrix Height Settable Meeting Table

- 25mm top panel.
- Sit / sit height adjustment of 650mm-850mm via single leg fixing.

Model	Dimensions	Price
AMT20/10	2000w x 1000d x 650-850h	£725
AMT18/10	1800w x 1000d x 650-850h	£708
AMT16/10	1600w x 1000d x 650-850h	£697
AMT14/10	1400w x 1000d x 650-850h	£688
AMT12/10	1200w x 1000d x 650-850h	£672
AMT10/10	1000w x 1000d x 650-850h	£663
AMT20/8	2000w x 800d x 650-850h	£709
AMT18/8	1800w x 800d x 650-850h	£699
AMT16/8	1600w x 800d x 650-850h	£688
AMT14/8	1400w x 800d x 650-850h	£670
AMT12/8	1200w x 800d x 650-850h	£659
AMT10/8	1000w x 800d x 650-850h	£644



MCONF34

Matrix Fixed Height Rectangular Conference Table

- 25mm top panel.

Model	Dimensions	Price
MCONF34	3400w x 1200d x 740h	£1,630

- 2x 1700mm Sections
- Seating up to 10 People



MMT16/12

Matrix Fixed Height Meeting Table

- 25mm top panel.

Model	Dimensions	Price
MMT20/16	2000w x 1600d x 740h	£845
MMT18/16	1800w x 1600d x 740h	£829
MMT16/16	1600w x 1600d x 740h	£816
MMT20/14	2000w x 1400d x 740h	£827
MMT18/14	1800w x 1400d x 740h	£811
MMT16/14	1600w x 1400d x 740h	£799
MMT14/14	1400w x 1400d x 740h	£791
MMT20/12	2000w x 1200d x 740h	£808
MMT18/12	1800w x 1200d x 740h	£794
MMT16/12	1600w x 1200d x 740h	£779
MMT14/12	1400w x 1200d x 740h	£771
MMT12/12	1200w x 1200d x 740h	£765
MMT20/10	2000w x 1000d x 740h	£579
MMT18/10	1800w x 1000d x 740h	£573
MMT16/10	1600w x 1000d x 740h	£566
MMT14/10	1400w x 1000d x 740h	£561
MMT12/10	1200w x 1000d x 740h	£554
MMT10/10	1000w x 1000d x 740h	£546
MMT20/8	2000w x 800d x 740h	£557
MMT18/8	1800w x 800d x 740h	£546
MMT16/8	1600w x 800d x 740h	£540
MMT14/8	1400w x 800d x 740h	£532
MMT12/8	1200w x 800d x 740h	£526
MMT10/8	1000w x 800d x 740h	£518

Matrix Accessories

Lead Time: Standard (All products are manufactured to order and when 'Standard Lead Time' is quoted (7 – 10 days), this may vary dependant on volume ordered, factory capacity and distribution requirements at the time of ordering. For more information please contact your Dealer Business Manager or the Customer Services Team for clarification.)

Metalwork: Available in Silver RAL 9006 (Standard), Black Graphite RAL 9004, White RAL 9003, Chrome Effect (Add 15%) and Raw finish (Add 5%)
Also available in Blue RAL 5001, Coral RAL 2001, Green RAL 6016, Light Grey RAL 7038, Teal RAL 5018 and Yellow RAL 1021 (Add 12% for all - 2 Week Lead Time)



Matrix Conference / Meeting Cable Tray

• High capacity cable management system neatly conceals power, data and telecom cables through a hinged cable management tray. • Cable trays are 222mm deep and 92mm high.

Model	Width	Price
MA8D	- For MCONF34 - 1400w	£126
MA10D	- For 2000w and 1600, 1400 and 1200d Meeting Tables - 1700w	£151
MA9D	- For 1800w and 1600, 1400 and 1200d Meeting Tables - 1500w	£133
MA7D	- For 1600w and 1600, 1400 and 1200d Meeting Tables - 1300w	£119
MA5D	- For 1400w and 1600, 1400 and 1200d Meeting Tables - 1100w	£101
MA3D	- For 1200w and 1600, 1400 and 1200d Meeting Tables - 900w	£92
MA2D	- For 1000w and 1600, 1400 and 1200d Meeting Tables - 700w	£76



Matrix Accessory Compatibility

- **BLACK** - Compatible
- **ORANGE** - Non-standard position required
- **BLUE** - Conflict when using screens
- **GREEN** - Unspecified

Accessory	Screens	Power and Data Modules	Monitor Arms
Workstations - Height Settable Rectangular	●	●	●
Workstations - Height Settable Angular	●	●	●
Workstations - Height Settable 120 Degree Workstation	●	●	●
Workstations - Height Settable Secretarial Return	●	●	●
Workstations - Fixed Height Double Benches	●	●	●
Workstations - Fixed Height Rectangular	●	●	●
Workstations - Fixed Height Angular	●	●	●
Workstations - Fixed Height Secretarial Return	●	●	●
Workstations - Fixed Height 120 Degree Cluster	●	●	●
Extensions			
Meeting - Height Settable Meeting		●	●
Meeting - Fixed Height Conference / Meeting		●	●

Accessory	Screens	Power and Data Modules	Monitor Arms
Matrix Screens, page 100-109	●		
Kaspa and Prime, page 309		●	
Boardroom, Conus and Peak, page 310-312		●	
Escalate, page 312		●	
Wireless Charging Unit, page 313		●	
Port Hole and Pix, page 314		●	
Pluto and Inca, page 315		●	
Flex and Capsule, page 316-317		●	
Plaza and Boost, page 318		●	
Wieland Socket Boxes, page 319		●	
M2, page 320			●
Flex, page 320-322			●
Ascend, page 321-322			●
Ollin and Flo, page 321-322			●
M8, page 322			●

Matrix System Screens for Height Settable Workstations

Lead Time: Standard (All products are manufactured to order and when 'Standard Lead Time' is quoted (7 – 10 days), this may vary dependant on volume ordered, factory capacity and distribution requirements at the time of ordering. For more information please contact your Dealer Business Manager or the Customer Services Team for clarification.)

Metalwork: Available in Anodised Silver (Standard), Black Graphite RAL 9004 and White RAL 9003

Fabric: Fully upholstered with pinnable surface available in Groups 1-7

Acrylic: Available in Blue, Green, Orange, Red, Frosted and Clear

MFC: Available in Ash, Autumn Cherry, Beech, Chester Oak, English Walnut, Grey, Grey Nebraska Oak, Laurentii Wenge, Natural Nebraska Oak and White

Matrix Desk Mounted System Screen for Height Settable Single Desks

- Straight dividing screens with aluminium trim and optional management rail.
- Screen is bracketed to the outer edge of the desk top.
- Link post not required. • Available as Hygiene Protection Screens and add-ons (see page 106-109).

- For Fabric, suffix ...F
- For Acrylic, suffix ...A
- For MFC without Management Rail, suffix ...MFC
- For MFC with Management Rail, suffix .../MFC



System Screens



System Screens with Management Rail



ASS16F

Straight System Screen

	Group 1	Group 2	Group 3	Group 4	Group 5	Group 6	Group 7	Acrylic	MFC
ASS20... - 1973w x 27d x 375h	£482	£494	£506	£518	£530	£542	£554	£482	-
ASS18... - 1773w x 27d x 375h	£456	£468	£480	£492	£504	£516	£528	£456	£416
ASS16... - 1573w x 27d x 375h	£419	£431	£443	£455	£467	£479	£491	£419	£382
ASS14... - 1373w x 27d x 375h	£391	£403	£415	£427	£439	£451	£463	£391	£355
ASS12... - 1173w x 27d x 375h	£355	£367	£379	£391	£403	£415	£427	£355	£323
ASS10... - 973w x 27d x 375h	£334	£346	£358	£370	£382	£394	£406	£334	£303
ASS8... - 773w x 27d x 375h	£314	£326	£338	£350	£362	£374	£386	£314	£285

Straight System Screen with Management Rail

ASS20M... - 1973w x 27d x 375h	£651	£663	£675	£687	£699	£711	£723	£651	-
ASS18M... - 1773w x 27d x 375h	£607	£619	£631	£643	£655	£667	£679	£607	£554
ASS16M... - 1573w x 27d x 375h	£564	£576	£588	£600	£612	£624	£636	£564	£510
ASS14M... - 1373w x 27d x 375h	£497	£509	£521	£533	£545	£557	£569	£497	£451
ASS12M... - 1173w x 27d x 375h	£460	£472	£484	£496	£508	£520	£532	£460	£418
ASS10M... - 973w x 27d x 375h	£419	£431	£443	£455	£467	£479	£491	£419	£382
ASS8M... - 773w x 27d x 375h	£381	£393	£405	£417	£429	£441	£453	£381	£345

Matrix Desk Mounted System Screen for Height Settable 120 Degree Workstations

- Straight dividing screens with aluminium trim and optional management rail.
- Screen is bracketed to the outer edge of the desk top.
- Link post not required. • Available as Hygiene Protection Screens and add-ons (see page 106-109).

- For Fabric, suffix ...F
- For Acrylic, suffix ...A
- For MFC without Management Rail, suffix ...MFC
- For MFC with Management Rail, suffix .../MFC



System Screens



System Screens with Management Rail



ASS120/12F

Straight System Screen

ASS120/12... - 1179w x 27d x 375h	£355	£367	£379	£391	£403	£415	£427	£355	£311
ASS120/10... - 979w x 27d x 375h	£334	£346	£358	£370	£382	£394	£406	£334	£303

Straight System Screen with Management Rail

ASS120/12M... - 1179w x 27d x 375h	£460	£472	£484	£496	£508	£520	£532	£460	£418
ASS120/10M... - 979w x 27d x 375h	£419	£431	£443	£455	£467	£479	£491	£419	£382

Matrix System and Acoustic Screens for Double Benches

Lead Time: Standard (All products are manufactured to order and when 'Standard Lead Time' is quoted (7 – 10 days), this may vary dependant on volume ordered, factory capacity and distribution requirements at the time of ordering. For more information please contact your Dealer Business Manager or the Customer Services Team for clarification.)

Metalwork: Available in Anodised Silver (Standard), Black Graphite RAL 9004 and White RAL 9003

Fabric: Fully upholstered with pinnable surface available in Groups 1-7

Acrylic: Available in Blue, Green, Orange, Red, Frosted and Clear

MFC: Available in Ash, Autumn Cherry, Beech, Chester Oak, English Walnut, Grey, Grey Nebraska Oak, Laurentii Wenge, Natural Nebraska Oak and White

Matrix Desk Mounted System Screen for Double Benches

- Straight dividing screens with aluminium trim and optional management rail.
- Screen is bracketed to the double bench leg frames.
- Optional 4 way link post available (**ELLP410**).
- Available as Hygiene Protection Screens and add-ons (see page 106-109).

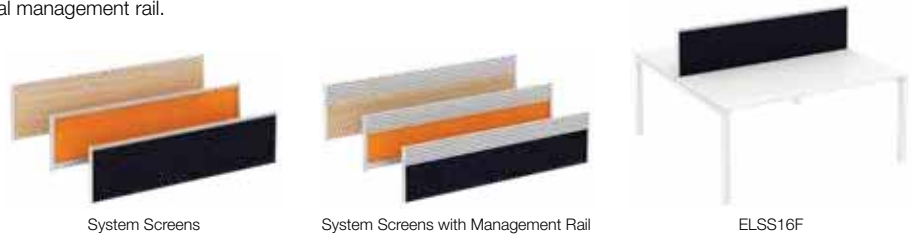

- For Fabric, suffix ...F
- For Acrylic, suffix ...A
- For MFC without Management Rail, suffix ...MFC
- For MFC with Management Rail, suffix .../MFC

Straight System Screen

	Group 1	Group 2	Group 3	Group 4	Group 5	Group 6	Group 7	Acrylic	MFC
ELSS20... - 1973w x 27d x 375h	£444	£456	£468	£480	£492	£504	£516	£444	£401
ELSS18... - 1773w x 27d x 375h	£419	£431	£443	£455	£467	£479	£491	£419	£382
ELSS16... - 1573w x 27d x 375h	£385	£397	£409	£421	£433	£445	£457	£385	£351
ELSS14... - 1373w x 27d x 375h	£357	£369	£381	£393	£405	£417	£429	£357	£324
ELSS12... - 1173w x 27d x 375h	£325	£337	£349	£361	£373	£385	£397	£325	£295
ELSS10... - 973w x 27d x 375h	£307	£319	£331	£343	£355	£367	£379	£307	£280

Straight System Screen with Management Rail

ELSS20M... - 1973w x 27d x 375h	£597	£609	£621	£633	£645	£657	£669	£597	£538
ELSS18M... - 1773w x 27d x 375h	£559	£571	£583	£595	£607	£619	£631	£559	£507
ELSS16M... - 1573w x 27d x 375h	£516	£528	£540	£552	£564	£576	£588	£516	£469
ELSS14M... - 1373w x 27d x 375h	£454	£466	£478	£490	£502	£514	£526	£454	£431
ELSS12M... - 1173w x 27d x 375h	£422	£434	£446	£458	£470	£482	£494	£422	£382
ELSS10M... - 973w x 27d x 375h	£385	£397	£409	£421	£433	£445	£457	£385	£348

Link Post

ELLP410 - 4 Way | £72 |

Matrix Desk Mounted Acoustic Screen for Double Benches

- Straight dividing screens faced with 6mm polyester fibre insulation board.
- Screen is bracketed to the double bench leg frames.
- Link post not required.
- Available as Hygiene Protection Screens and add-ons (see page 106-109).

• Class B certified in accordance with International Standards:

- ISO 354:2003
- ISO 11654:1997
- ISO 9613-1:1993



Straight Acoustic Screen

	Group 1	Group 2	Group 3	Group 4	Group 5	Group 6	Group 7
AELSS20F - 1973w x 38d x 375h	£557	£569	£581	£593	£605	£617	£629
AELSS18F - 1773w x 38d x 375h	£526	£538	£550	£562	£574	£586	£598
AELSS16F - 1573w x 38d x 375h	£482	£494	£506	£518	£530	£542	£554
AELSS14F - 1373w x 38d x 375h	£449	£461	£473	£485	£497	£509	£521
AELSS12F - 1173w x 38d x 375h	£409	£421	£433	£445	£457	£469	£481
AELSS10F - 973w x 38d x 375h	£386	£398	£410	£422	£434	£446	£458

Lead Time: Standard (All products are manufactured to order and when 'Standard Lead Time' is quoted (7 – 10 days), this may vary dependant on volume ordered, factory capacity and distribution requirements at the time of ordering. For more information please contact your Dealer Business Manager or the Customer Services Team for clarification.)

Metalwork: Available in Anodised Silver (Standard), Black Graphite RAL 9004 and White RAL 9003

Fabric: Fully upholstered with pinnable surface available in Groups 1-7

Acrylic: Available in Blue, Green, Orange, Red, Frosted and Clear

MFC: Available in Ash, Autumn Cherry, Beech, Chester Oak, English Walnut, Grey, Grey Nebraska Oak, Laurentii Wenge, Natural Nebraska Oak and White

Elite Desk Mounted Mid Return System Screen for Double Benches

- Straight dividing screens with aluminium trim.
- Screen is fixed to the link post at one end and uses a metal blade between the desk tops to fix its position.
- 4 way link post required (**ELLP410**).
- Available as Hygiene Protection Screens and add-ons (see page 106-109).

- For Fabric, suffix **...F**
- For Acrylic, suffix **...A**
- For MFC without Management Rail, suffix **...MFC**



Straight System Screen	Group 1	Group 2	Group 3	Group 4	Group 5	Group 6	Group 7	Acrylic	MFC
ESSMR8... - 773w x 27d x 375h	£295	£307	£319	£331	£343	£355	£367	£295	£263
ESSMR7... - 673w x 27d x 375h	£288	£300	£312	£324	£336	£348	£360	£288	£259
ESSMR6... - 573w x 27d x 375h	£282	£294	£306	£318	£330	£342	£354	£282	£251

Link Post

ELLP410 - 4 Way | £72 |

Elite Desk Mounted Flexible Return Contract Screen for Double Benches

- 2 week lead time.
- Straight dividing screen with rounded corners.
- Screen slides onto the front of the desktop at desired position and can be moved at any time.
- Screens overhang the front of the desktop by 143mm.



Straight Contract Screen	Group 1	Group 2	Group 3	Group 4	Group 5	Group 6	Group 7
ECSFR8 - 900w x 36d x 375h	£329	£341	£353	£365	£377	£389	£401
ECSFR7 - 800w x 36d x 375h	£322	£334	£346	£358	£370	£382	£394
ECSFR6 - 700w x 36d x 375h	£317	£329	£341	£353	£365	£377	£389

Matrix System and Acoustic Screens for Single Desks

Lead Time: Standard (All products are manufactured to order and when 'Standard Lead Time' is quoted (7 – 10 days), this may vary dependant on volume ordered, factory capacity and distribution requirements at the time of ordering. For more information please contact your Dealer Business Manager or the Customer Services Team for clarification.)

Metalwork: Available in Anodised Silver (Standard), Black Graphite RAL 9004 and White RAL 9003

Fabric: Fully upholstered with pinnable surface available in Groups 1-7

Acrylic: Available in Blue, Green, Orange, Red, Frosted and Clear

MFC: Available in Ash, Autumn Cherry, Beech, Chester Oak, English Walnut, Grey, Grey Nebraska Oak, Laurentii Wenge, Natural Nebraska Oak and White

Matrix Desk Mounted System Screen for Single Desks

- Straight dividing screens with aluminium trim and optional management rail.
- Screen is bracketed to the outer edge of the desk top.
- Optional 4 way link post available (**ELP375**).
- Available as Hygiene Protection Screens and add-ons (see page 106-109).



- For Fabric, suffix **...F**
- For Acrylic, suffix **...A**
- For MFC without Management Rail, suffix **...MFC**
- For MFC with Management Rail, suffix **.../MFC**

Straight System Screen

	Group 1	Group 2	Group 3	Group 4	Group 5	Group 6	Group 7	Acrylic	MFC
ESS20... - 1973w x 27d x 375h	£444	£456	£468	£480	£492	£504	£516	£444	£401
ESS18... - 1773w x 27d x 375h	£419	£431	£443	£455	£467	£479	£491	£419	£382
ESS16... - 1573w x 27d x 375h	£385	£397	£409	£421	£433	£445	£457	£385	£351
ESS14... - 1373w x 27d x 375h	£357	£369	£381	£393	£405	£417	£429	£357	£324
ESS12... - 1173w x 27d x 375h	£325	£337	£349	£361	£373	£385	£397	£325	£295
ESS10... - 973w x 27d x 375h	£307	£319	£331	£343	£355	£367	£379	£307	£280

Straight System Screen with Management Rail

ESS20M... - 1973w x 27d x 375h	£597	£609	£621	£633	£645	£657	£669	£597	£538
ESS18M... - 1773w x 27d x 375h	£559	£571	£583	£595	£607	£619	£631	£559	£507
ESS16M... - 1573w x 27d x 375h	£516	£528	£540	£552	£564	£576	£588	£516	£469
ESS14M... - 1373w x 27d x 375h	£454	£466	£478	£490	£502	£514	£526	£454	£431
ESS12M... - 1173w x 27d x 375h	£422	£434	£446	£458	£470	£482	£494	£422	£382
ESS10M... - 973w x 27d x 375h	£385	£397	£409	£421	£433	£445	£457	£385	£348

Link Post

ELP375 - 4 Way | £72 |

Matrix Desk Mounted Acoustic Screen for Single Desks

- Straight dividing screens faced with 6mm polyester fibre insulation board.
- Screen is bracketed to the outer edge of the desk top.
- Link post not required.
- Available as Hygiene Protection Screens and add-ons (see page 106-109).

• Class B certified in accordance with International Standards:

- ISO 354:2003
- ISO 11654:1997
- ISO 9613-1:1993



Straight Acoustic Screen

	Group 1	Group 2	Group 3	Group 4	Group 5	Group 6	Group 7
AESS20F - 1973w x 38d x 375h	£557	£569	£581	£593	£605	£617	£629
AESS18F - 1773w x 38d x 375h	£526	£538	£550	£562	£574	£586	£598
AESS16F - 1573w x 38d x 375h	£482	£494	£506	£518	£530	£542	£554
AESS14F - 1373w x 38d x 375h	£449	£461	£473	£485	£497	£509	£521
AESS12F - 1173w x 38d x 375h	£409	£421	£433	£445	£457	£469	£481
AESS10F - 973w x 38d x 375h	£386	£398	£410	£422	£434	£446	£458

Matrix Return and 120 Degree System Screens for Single Desks

Lead Time: Standard (All products are manufactured to order and when 'Standard Lead Time' is quoted (7 – 10 days), this may vary dependant on volume ordered, factory capacity and distribution requirements at the time of ordering. For more information please contact your Dealer Business Manager or the Customer Services Team for clarification.)

Metalwork: Available in Anodised Silver (Standard), Black Graphite RAL 9004 and White RAL 9003

Fabric: Fully upholstered with pinnable surface available in Groups 1-7

Acrylic: Available in Blue, Green, Orange, Red, Frosted and Clear

MFC: Available in Ash, Autumn Cherry, Beech, Chester Oak, English Walnut, Grey, Grey Nebraska Oak, Laurentii Wenge, Natural Nebraska Oak and White

Matrix Desk Mounted Mid Return System Screen for Single Desks

- Straight dividing screens with aluminium trim and optional management rail.
- Screen is fixed to the Link Post at one end and uses a metal blade between the desk tops to fix its position.
- 4 way link post required (**ELP375**).
- Available as Hygiene Protection Screens and add-ons (see page 106-109).



- For Fabric, suffix **...F**
- For Acrylic, suffix **...A**
- For MFC without Management Rail, suffix **...MFC**
- For MFC with Management Rail, suffix **.../MFC**

Straight System Screen

	Group 1	Group 2	Group 3	Group 4	Group 5	Group 6	Group 7	Acrylic	MFC
ESSMR20... - 1973w x 27d x 375h	£444	£456	£468	£480	£492	£504	£516	£444	£401
ESSMR18... - 1773w x 27d x 375h	£419	£431	£443	£455	£467	£479	£491	£419	£382
ESSMR17... - 1673w x 27d x 375h	£404	£416	£428	£440	£452	£464	£476	£404	£366
ESSMR16... - 1573w x 27d x 375h	£385	£397	£409	£421	£433	£445	£457	£385	£351
ESSMR10... - 973w x 27d x 375h	£307	£319	£331	£343	£355	£367	£379	£307	£280
ESSMR8... - 773w x 27d x 375h	£295	£307	£319	£331	£343	£355	£367	£295	£263
ESSMR7... - 673w x 27d x 375h	£288	£300	£312	£324	£336	£348	£360	£288	£259
ESSMR6... - 573w x 27d x 375h	£282	£294	£306	£318	£330	£342	£354	£282	£251

Straight System Screen with Management Rail

ESSMR20M... - 1973w x 27d x 375h	£597	£609	£621	£633	£645	£657	£669	£597	£538
ESSMR18M... - 1773w x 27d x 375h	£559	£571	£583	£595	£607	£619	£631	£559	£507
ESSMR17M... - 1673w x 27d x 375h	£536	£548	£560	£572	£584	£596	£608	£536	£489
ESSMR16M... - 1573w x 27d x 375h	£516	£528	£540	£552	£564	£576	£588	£516	£469
ESSMR10M... - 973w x 27d x 375h	£385	£397	£409	£421	£433	£445	£457	£385	£348
ESSMR8M... - 773w x 27d x 375h	£371	£383	£395	£407	£419	£431	£443	£371	£331
ESSMR7M... - 673w x 27d x 375h	£364	£376	£388	£400	£412	£424	£436	£364	£323
ESSMR6M... - 573w x 27d x 375h	£357	£369	£381	£393	£405	£417	£429	£357	£317

Link Post

ELP375 - 4 Way | £72 |

Matrix Desk Mounted System Screen for 120 Degree Workstations

- Straight dividing screens with aluminium trim and optional management rail.
- Screen is fixed to the link post at one end and is bracketed to the leg frame at the other.
- 3 way link post required (**ELP375/120**).
- Available as Hygiene Protection Screens and add-ons (see page 106-109).



- For Fabric, suffix **...F**
- For Acrylic, suffix **...A**
- For MFC without Management Rail, suffix **...MFC**
- For MFC with Management Rail, suffix **.../MFC**

Straight System Screen

	Group 1	Group 2	Group 3	Group 4	Group 5	Group 6	Group 7	Acrylic	MFC
ESS120/12... - 1179w x 27d x 375h	£325	£337	£349	£361	£373	£385	£397	£325	£295
ESS120/10... - 979w x 27d x 375h	£307	£319	£331	£343	£355	£367	£379	£307	£280

Straight System Screen with Management Rail

ESS120/12M... - 1179w x 27d x 375h	£422	£434	£446	£458	£470	£482	£494	£422	£382
ESS120/10M... - 979w x 27d x 375h	£385	£397	£409	£421	£433	£445	£457	£385	£348

Link Post

ELP375/120 - 3 Way | £72 |

Matrix Contract Screens and Accessories

Lead Time: Standard (All products are manufactured to order and when 'Standard Lead Time' is quoted (7 – 10 days), this may vary dependant on volume ordered, factory capacity and distribution requirements at the time of ordering. For more information please contact your Dealer Business Manager or the Customer Services Team for clarification.)

Fabric: Fully upholstered with pinnable surface available in Groups 1-7

Matrix Desk Mounted Contract Screen for Double Benches

- Straight dividing screens.
- Screen is bracketed to the double bench leg frames.
- Link post not required.
- Available as Hygiene Protection Screens and add-ons (see page 106-109).



Straight Contract Screen



ECS16F/M

Straight Contract Screen

	Group 1	Group 2	Group 3	Group 4	Group 5	Group 6	Group 7
ECS20F/M - 1970w x 27d x 375h	£281	£293	£305	£317	£329	£341	£353
ECS18F/M - 1770w x 27d x 375h	£270	£282	£294	£306	£318	£330	£342
ECS16F/M - 1570w x 27d x 375h	£261	£273	£285	£297	£309	£321	£333
ECS14F/M - 1370w x 27d x 375h	£248	£260	£272	£284	£296	£308	£320
ECS12F/M - 1170w x 27d x 375h	£236	£248	£260	£272	£284	£296	£308
ECS10F/M - 970w x 27d x 375h	£223	£235	£247	£259	£271	£283	£295

Matrix Desk Mounted Contract Screen for Single Desks

- Straight dividing screens.
- Screen is bracketed to the outer edge of the desk top.
- Link post not required.
- Available as Hygiene Protection Screens and add-ons (see page 106-109).

- For Back to Back Desking, use standard code
- For Stand Alone Desking, suffix .../X



Straight Contract Screen



ECS16F/X

Straight Contract Screen

	Group 1	Group 2	Group 3	Group 4	Group 5	Group 6	Group 7
ECS20F... - 1970w x 27d x 375h	£281	£293	£305	£317	£329	£341	£353
ECS18F... - 1770w x 27d x 375h	£270	£282	£294	£306	£318	£330	£342
ECS16F... - 1570w x 27d x 375h	£261	£273	£285	£297	£309	£321	£333
ECS14F... - 1370w x 27d x 375h	£248	£260	£272	£284	£296	£308	£320
ECS12F... - 1170w x 27d x 375h	£236	£248	£260	£272	£284	£296	£308
ECS10F... - 970w x 27d x 375h	£223	£235	£247	£259	£271	£283	£295



CSNP/S

Contract Screen Name Plate

- Fabricated steel. • Compatible with straight contract screens only.
- Removable magnetic perspex front.

Metalwork

CSNP/S - Silver - 210w x 38d x 45h	£70
CSNP/B - Black - 210w x 38d x 45h	£70
CSNP/W - White - 210w x 38d x 45h	£70



CSVPT/S

Contract Screen Vertical A4 Paper Tray

- Fabricated steel. • Compatible with straight contract screens only.
- Supplied with 3 magnets.

Metalwork

CSVPT/S - Silver - 330w x 90d x 235h	£80
CSVPT/B - Black - 330w x 90d x 235h	£80
CSVPT/W - White - 330w x 90d x 235h	£80

Matrix Acrylic Hygiene Protection Screens for Double Benches

Lead Time: Standard (All products are manufactured to order and when 'Standard Lead Time' is quoted (7 – 10 days), this may vary dependant on volume ordered, factory capacity and distribution requirements at the time of ordering. For more information please contact your Dealer Business Manager or the Customer Services Team for clarification.)

Acrylic: Clear

Metalwork: Fixing Brackets and Freestanding Feet supplied in Silver RAL 9006 (Standard) - Optional Black Graphite RAL 9004 and White RAL 9003



Acrylic Illustrated in Blue



ELHPS16/M
Acrylic Illustrated in Blue



Matrix Desk Mounted Acrylic Hygiene Protection Screen for Double Benches

- The workstation top must be removed in order to fix this bracket to the desktop.
- Rectangular acrylic dividing screens supplied with fixing brackets.
- Screen is clamped to the desktop.
- Brackets supplied in Silver RAL 9006 as standard.

Matrix Desk Mounted Screen

		Price
ELHPS20	- 1973w x 5d x 700h	£367
ELHPS18	- 1773w x 5d x 700h	£342
ELHPS16	- 1573w x 5d x 700h	£316
ELHPS14	- 1373w x 5d x 700h	£294
ELHPS12	- 1173w x 5d x 700h	£265
ELHPS10	- 973w x 5d x 700h	£238



EHPSMR8
Acrylic Illustrated in Blue



Matrix Desk Mounted Mid Return Acrylic Hygiene Protection Screen for Double Benches

- The workstation top must be removed in order to fix this bracket to the desktop.
- Rectangular acrylic dividing screens supplied with 1x freestanding foot and 1x fixing bracket.
- Screen is clamped to the desktop.
- Freestanding feet and brackets supplied in Silver RAL 9006 as standard.

Matrix Desk Mounted Mid Return Screen

		Price
EHPSMR8	- 780w x 5d x 700h	£248
EHPSMR7	- 680w x 5d x 700h	£235
EHPSMR6	- 580w x 5d x 700h	£222

Matrix Acrylic Hygiene Protection Screens for Double Benches

Lead Time: Standard (All products are manufactured to order and when 'Standard Lead Time' is quoted (7 – 10 days), this may vary dependant on volume ordered, factory capacity and distribution requirements at the time of ordering. For more information please contact your Dealer Business Manager or the Customer Services Team for clarification.)

Acrylic: Clear

Metalwork: Fixing Brackets supplied in Silver RAL 9006 (Standard) - Optional Black Graphite RAL 9004 and White RAL 9003



EHPSER8
Acrylic Illustrated in Blue



Matrix Desk Mounted End Return Acrylic Hygiene Protection Screen for Double Benches

- The workstation top must be removed in order to fix this bracket to the desktop.
- Rectangular acrylic dividing screens supplied with fixing brackets.
- Screen is clamped to the desktop.
- Brackets supplied in Silver RAL 9006 as standard.

Matrix Desk Mounted End Return Screen

		Price
EHPSER8	- 780w x 5d x 700h	£248
EHPSER7	- 680w x 5d x 700h	£235
EHPSER6	- 580w x 5d x 700h	£222



ELSS16/HPS
Acrylic Illustrated in Blue



Matrix Desk Mounted Acrylic Hygiene Protection Screen for Double Benches with Screens

- Rectangular acrylic dividing screens supplied with brackets.
- Screen is bracketed to the existing screen frame.
- Brackets supplied in Silver RAL 9006 as standard.
- Screens compatible with Non-Elite Desk Mounted Screens available.

Addition for 27mm Matrix Desk Mounted System Screen

		Price
ELSS20/HPS	- 1973w x 5d x 325h	£224
ELSS18/HPS	- 1773w x 5d x 325h	£212
ELSS16/HPS	- 1573w x 5d x 325h	£199
ELSS14/HPS	- 1373w x 5d x 325h	£189
ELSS12/HPS	- 1173w x 5d x 325h	£171
ELSS10/HPS	- 973w x 5d x 325h	£158



Addition for 38mm Matrix Desk Mounted Acoustic Screen

		Price
AELSS20F/HPS	- 1973w x 5d x 325h	£224
AELSS18F/HPS	- 1773w x 5d x 325h	£212
AELSS16F/HPS	- 1573w x 5d x 325h	£199
AELSS14F/HPS	- 1373w x 5d x 325h	£189
AELSS12F/HPS	- 1173w x 5d x 325h	£171
AELSS10F/HPS	- 973w x 5d x 325h	£158



Addition for 27mm Matrix Desk Mounted Contract Screen

		Price
ECS20F/HPS	- 1970w x 5d x 325h	£224
ECS18F/HPS	- 1770w x 5d x 325h	£212
ECS16F/HPS	- 1570w x 5d x 325h	£199
ECS14F/HPS	- 1370w x 5d x 325h	£189
ECS12F/HPS	- 1170w x 5d x 325h	£171
ECS10F/HPS	- 970w x 5d x 325h	£158

Matrix Acrylic Hygiene Protection Screens for Double Benches and Single Desks

Lead Time: Standard (All products are manufactured to order and when 'Standard Lead Time' is quoted (7 – 10 days), this may vary dependant on volume ordered, factory capacity and distribution requirements at the time of ordering. For more information please contact your Dealer Business Manager or the Customer Services Team for clarification.)

Acrylic: Clear

Metalwork: Fixing Brackets supplied in Silver RAL 9006 (Standard) - Optional Black Graphite RAL 9004 and White RAL 9003



EHPS16
Acrylic Illustrated in Blue



EHPS16/O
Acrylic Illustrated in Blue



Matrix Desk Mounted Acrylic Hygiene Protection Screen for Single Desks

- Rectangular acrylic dividing screens supplied with fixing brackets.
- Screen is clamped to the desktop.
- Brackets supplied in Silver RAL 9006 as standard.
- For a central opening of 400w x 60h, suffix **.../O**.

Matrix Desk Mounted Screen

	Price
EHPS20 - 1973w x 5d x 700h	£367
EHPS18 - 1773w x 5d x 700h	£342
EHPS16 - 1573w x 5d x 700h	£316
EHPS14 - 1373w x 5d x 700h	£294
EHPS12 - 1173w x 5d x 700h	£265
EHPS10 - 973w x 5d x 700h	£238



ESS16/HPS
Acrylic Illustrated in Blue



Matrix Desk Mounted Acrylic Hygiene Protection Screen for Single Desks with Screens

- Rectangular acrylic dividing screens supplied with brackets.
- Screen is bracketed to the existing screen frame.
- Brackets supplied in Silver RAL 9006 as standard.
- Screens compatible with Non-Elite Desk Mounted Screens available.

Addition for 27mm Matrix Desk Mounted System Screen

	Price
ESS20/HPS - 1973w x 5d x 325h	£224
ESS18/HPS - 1773w x 5d x 325h	£212
ESS16/HPS - 1573w x 5d x 325h	£199
ESS14/HPS - 1373w x 5d x 325h	£189
ESS12/HPS - 1173w x 5d x 325h	£171
ESS10/HPS - 973w x 5d x 325h	£158

Addition for 38mm Matrix Desk Mounted Acoustic Screen

AESS20F/HPS - 1973w x 5d x 325h	£224
AESS18F/HPS - 1773w x 5d x 325h	£212
AESS16F/HPS - 1573w x 5d x 325h	£199
AESS14F/HPS - 1373w x 5d x 325h	£189
AESS12F/HPS - 1173w x 5d x 325h	£171
AESS10F/HPS - 973w x 5d x 325h	£158

Addition for 27mm Matrix Desk Mounted Contract Screen

ECS20F/HPS - 1970w x 5d x 325h	£224
ECS18F/HPS - 1770w x 5d x 325h	£212
ECS16F/HPS - 1570w x 5d x 325h	£199
ECS14F/HPS - 1370w x 5d x 325h	£189
ECS12F/HPS - 1170w x 5d x 325h	£171
ECS10F/HPS - 970w x 5d x 325h	£158

Matrix Acrylic Hygiene Protection Screens for Single Desks and 120 Degree Workstations

Lead Time: Standard (All products are manufactured to order and when 'Standard Lead Time' is quoted (7 – 10 days), this may vary dependant on volume ordered, factory capacity and distribution requirements at the time of ordering. For more information please contact your Dealer Business Manager or the Customer Services Team for clarification.)

Acrylic: Clear

Metalwork: Fixing Brackets and Freestanding Feet supplied in Silver RAL 9006 (Standard) - Optional Black Graphite RAL 9004 and White RAL 9003



EHPSMR8
Acrylic Illustrated in Blue



Matrix Desk Mounted Mid Return Acrylic Hygiene Protection Screen for Single Desks

- Rectangular acrylic dividing screens supplied with 1x freestanding foot and 1x fixing bracket.
- Screen is clamped to the desktop.
- Freestanding feet and brackets supplied in Silver RAL 9006 as standard.

Matrix Desk Mounted Mid Return Screen

	Price
EHPSMR10 - 980w x 5d x 700h	£260
EHPSMR8 - 780w x 5d x 700h	£248
EHPSMR7 - 680w x 5d x 700h	£235
EHPSMR6 - 580w x 5d x 700h	£222



EHPSE8
Acrylic Illustrated in Blue



Matrix Desk Mounted End Return Acrylic Hygiene Protection Screen for Single Desks

- The workstation top must be removed in order to fix this bracket to the desktop.
- Rectangular acrylic dividing screens supplied with fixing brackets.
- Screen is clamped to the desktop.
- Brackets supplied in Silver RAL 9006 as standard.

Matrix Desk Mounted End Return Screen

	Price
EHPSE10 - 980w x 5d x 700h	£260
EHPSE8 - 780w x 5d x 700h	£248
EHPSE7 - 680w x 5d x 700h	£235
EHPSE6 - 580w x 5d x 700h	£222



EHPS120/12
Acrylic Illustrated in Blue



EHPS120/12/O
Acrylic Illustrated in Blue



Matrix Desk Mounted Acrylic Hygiene Protection Screen for 120 Degree Workstations

- Rectangular acrylic dividing screens supplied with fixing brackets.
- Screen is clamped to the desktop.
- Brackets supplied in Silver RAL 9006 as standard.
- For a central opening of 400w x 60h, suffix **.../O**.

Matrix Desk Mounted System Screen

	Price
EHPS120/12 - 1179w x 5d x 700h	£268
EHPS120/10 - 979w x 5d x 700h	£243



ESS120/12/HPS
Acrylic Illustrated in Blue



Matrix Desk Mounted Acrylic Hygiene Protection Screen for 120 Degree Workstations with Screens

- Rectangular acrylic dividing screens supplied with brackets.
- Screen is bracketed to the existing screen frame.
- Brackets supplied in Silver RAL 9006 as standard.
- Screens compatible with Non-Elite Desk Mounted Screens available.

Addition for 27mm Matrix Desk Mounted System Screen

	Price
ESS120/12/HPS - 1179w x 5d x 325h	£184
ESS120/10/HPS - 979w x 5d x 325h	£163

Kassini Manual Sit / Sit Adjustable and Fixed Height Workstations



The Kassini range offers a myriad of options that fully utilise the unique wire management solution. Leg risers within the leg upright can be removed to enable cables to be routed vertically within the leg channel and directed into the modesty panel or wire management beam to discreetly house cables and wires. Power and data modules can easily be mounted at any position along the cable beams offering maximum flexibility for complex cable installations. The height adjustable workstations offer adjustment from 650mm to 850mm via a manual rotating handle that can be discreetly retracted within the frame, when not in use. The unique design of Kassini and the minimal number of components required, ensures a swift and efficient assembly process, reducing installation costs. Due to the nature of aluminium, Kassini offers an environmentally friendly solution as the lightweight frame can be re-cycled at the end of its life cycle.

Kassini Height Adjustable Workstations

Lead Time: Standard (All products are manufactured to order and when 'Standard Lead Time' is quoted (7 – 10 days), this may vary dependant on volume ordered, factory capacity and distribution requirements at the time of ordering. For more information please contact your Dealer Business Manager or the Customer Services Team for clarification.)

Wood: Available in MFC (Ash, Autumn Cherry, Beech, Chester Oak, English Walnut, Grey, Grey Nebraska Oak, Laurentii Wenge, Natural Nebraska Oak and White)
Top Panel Edge Detail available on 25mm White MFC (Wenge and Black - Add £32 Retail Per Top) (Plywood - Add £42 Retail Per Top)
Available in Veneer (Oak and Walnut) on a 3 Week Lead Time

Metalwork: Available in Silver RAL 9006 (Standard), Black Graphite RAL 9004, White RAL 9003 and Chrome Effect (Add 15%)



KR16/HA

Kassini Height Adjustable Rectangular Desk

- 25mm top panel. • Sit / sit height adjustment of 650mm-850mm via crank handle.
- Horizontal wire management as standard. • Vertical wire management not available.

		MFC	Veneer (3 Week Lead Time)
KR18/HA	- 1800w x 800d x 650-850h	£1,181	£1,486
KR16/HA	- 1600w x 800d x 650-850h	£1,150	£1,452
KR14/HA	- 1400w x 800d x 650-850h	£1,137	£1,425
KR12/HA	- 1200w x 800d x 650-850h	£1,110	£1,399
KR10/HA	- 1000w x 800d x 650-850h	£1,090	£1,363
KR8/HA	- 800w x 800d x 650-850h	£1,042	£1,290
KR18/6/HA	- 1800w x 600d x 650-850h	£1,150	£1,452
KR16/6/HA	- 1600w x 600d x 650-850h	£1,138	£1,431
KR14/6/HA	- 1400w x 600d x 650-850h	£1,119	£1,405
KR12/6/HA	- 1200w x 600d x 650-850h	£1,101	£1,378
KR10/6/HA	- 1000w x 600d x 650-850h	£1,079	£1,345
KR8/6/HA	- 800w x 600d x 650-850h	£1,036	£1,276



KRB16/HA

Kassini Height Adjustable Bow Fronted Rectangular Desk

- 25mm top panel. • Sit / sit height adjustment of 650mm-850mm via crank handle.
- Horizontal wire management as standard. • Vertical wire management not available.

		MFC	Veneer (3 Week Lead Time)
KRB18/HA	- 1800w x 900d x 650-850h	£1,434	£1,857
KRB16/HA	- 1600w x 900d x 650-850h	£1,407	£1,822



KR20DRH/HA

Kassini Height Adjustable 'D' Ended Desk

- 25mm top panel. • Sit / sit height adjustment of 650mm-850mm via crank handle.
- Horizontal wire management as standard. • Vertical wire management not available.

		MFC	Veneer (3 Week Lead Time)
KR22DLH/HA	- 2200w x 800d x 650-850h	£1,486	£1,941
KR22DRH/HA	- 2200w x 800d x 650-850h	£1,486	£1,941
KR20DLH/HA	- 2000w x 800d x 650-850h	£1,471	£1,916
KR20DRH/HA	- 2000w x 800d x 650-850h	£1,471	£1,916

Kassini Height Adjustable Workstations and Accessories

Lead Time: Standard (All products are manufactured to order and when 'Standard Lead Time' is quoted (7 – 10 days), this may vary dependant on volume ordered, factory capacity and distribution requirements at the time of ordering. For more information please contact your Dealer Business Manager or the Customer Services Team for clarification.)

Wood: Available in MFC (Ash, Autumn Cherry, Beech, Chester Oak, English Walnut, Grey, Grey Nebraska Oak, Laurentii Wenge, Natural Nebraska Oak and White)
Top Panel Edge Detail available on 25mm White MFC (Wenge and Black - Add £32 Retail Per Top) (Plywood - Add £42 Retail Per Top)
Available in Veneer (Oak and Walnut) on a 3 Week Lead Time

Metalwork: Available in Silver RAL 9006 (Standard), Black Graphite RAL 9004, White RAL 9003 and Chrome Effect (Add 15%)



Kassini Height Adjustable Crescent Workstation

- 25mm top panel.
- Sit / sit height adjustment of 650mm-850mm via crank handle.
- Horizontal wire management as standard.
- Vertical wire management not available.
- 600mm return.

	MFC	Veneer (3 Week Lead Time)
KC18LH/HA - 1800w x 1200d x 650-850h	£1,655	£2,116
KC18RH/HA - 1800w x 1200d x 650-850h	£1,655	£2,116
KC16LH/HA - 1600w x 1200d x 650-850h	£1,613	£2,059
KC16RH/HA - 1600w x 1200d x 650-850h	£1,613	£2,059
KC14LH/HA - 1400w x 1200d x 650-850h	£1,587	£2,009
KC14RH/HA - 1400w x 1200d x 650-850h	£1,587	£2,009



Kassini Height Adjustable Bow Fronted Crescent Workstation

- 25mm top panel.
- Sit / sit height adjustment of 650mm-850mm via crank handle.
- Horizontal wire management as standard.
- Vertical wire management not available.
- 600mm return.

	MFC	Veneer (3 Week Lead Time)
KCB18LH/HA - 1800w x 1300d x 650-850h	£1,909	£2,480
KCB18RH/HA - 1800w x 1300d x 650-850h	£1,909	£2,480



Kassini Height Adjustable Single Wave Desk

- 25mm top panel.
- Sit / sit height adjustment of 650mm-850mm via crank handle.
- Horizontal wire management as standard.
- Vertical wire management not available.

	MFC	Veneer (3 Week Lead Time)
KW18LH/HA - 1800w x 1000-800d x 650-850h	£1,311	£1,843
KW18RH/HA - 1800w x 1000-800d x 650-850h	£1,311	£1,843
KW16LH/HA - 1600w x 1000-800d x 650-850h	£1,282	£1,806
KW16RH/HA - 1600w x 1000-800d x 650-850h	£1,282	£1,806
KW14LH/HA - 1400w x 1000-800d x 650-850h	£1,256	£1,770
KW14RH/HA - 1400w x 1000-800d x 650-850h	£1,256	£1,770
KW12LH/HA - 1200w x 1000-800d x 650-850h	£1,224	£1,723
KW12RH/HA - 1200w x 1000-800d x 650-850h	£1,224	£1,723
KW18/6LH/HA - 1800w x 800-600d x 650-850h	£1,272	£1,791
KW18/6RH/HA - 1800w x 800-600d x 650-850h	£1,272	£1,791
KW16/6LH/HA - 1600w x 800-600d x 650-850h	£1,247	£1,754
KW16/6RH/HA - 1600w x 800-600d x 650-850h	£1,247	£1,754
KW14/6LH/HA - 1400w x 800-600d x 650-850h	£1,220	£1,720
KW14/6RH/HA - 1400w x 800-600d x 650-850h	£1,220	£1,720
KW12/6LH/HA - 1200w x 800-600d x 650-850h	£1,193	£1,674
KW12/6RH/HA - 1200w x 800-600d x 650-850h	£1,193	£1,674



Kassini Height Adjustable 120 Degree Workstation

- 25mm top panel.
- Sit / sit height adjustment of 650mm-850mm via crank handle.
- Can be configured as a singular workstation or in modules of 3, 6, 9 etc.
- Horizontal wire management as standard.
- Vertical wire management not available.

	MFC	Veneer (3 Week Lead Time)
K120/HA - 2078w (extreme) x 800d x 650-850h	£1,646	£2,105
K120/6/HA - 1732w (extreme) x 600d x 650-850h	£1,586	£1,963



Slinky Cable Riser

- Suitable for all desking ranges.

	Price
SCR/S - Silver	£59
SCR/B - Black	£59
SCR/W - White	£59

SCR/S - SCR/B - SCR/W

Kassini Fixed Height Workstations

Lead Time: Standard (All products are manufactured to order and when 'Standard Lead Time' is quoted (7 – 10 days), this may vary dependant on volume ordered, factory capacity and distribution requirements at the time of ordering. For more information please contact your Dealer Business Manager or the Customer Services Team for clarification.)

Wood: Available in MFC (Ash, Autumn Cherry, Beech, Chester Oak, English Walnut, Grey, Grey Nebraska Oak, Laurentii Wenge, Natural Nebraska Oak and White)
Top Panel Edge Detail available on 25mm White MFC (Wenge and Black - Add £32 Retail Per Top) (Plywood - Add £42 Retail Per Top)
Available in Veneer (Oak and Walnut) on a 3 Week Lead Time

Metalwork: Available in Silver RAL 9006 (Standard), Black Graphite RAL 9004, White RAL 9003 and Chrome Effect (Add 15%)



KR16

Kassini Fixed Height Rectangular Desk

• 25mm top panel. • Horizontal and vertical wire management as standard.

	MFC	Veneer (3 Week Lead Time)
KR18 - 1800w x 800d x 740h	£663	£954
KR16 - 1600w x 800d x 740h	£633	£918
KR14 - 1400w x 800d x 740h	£620	£893
KR12 - 1200w x 800d x 740h	£596	£865
KR10 - 1000w x 800d x 740h	£572	£828
KR8 - 800w x 800d x 740h	£526	£753
KR18/6 - 1800w x 600d x 740h	£633	£918
KR16/6 - 1600w x 600d x 740h	£622	£898
KR14/6 - 1400w x 600d x 740h	£602	£869
KR12/6 - 1200w x 600d x 740h	£584	£844
KR10/6 - 1000w x 600d x 740h	£564	£811
KR8/6 - 800w x 600d x 740h	£520	£744



KRB16

Kassini Fixed Height Bow Fronted Rectangular Desk

• 25mm top panel. • Horizontal and vertical wire management as standard.

	MFC	Veneer (3 Week Lead Time)
KRB18 - 1800w x 900d x 740h	£917	£1,325
KRB16 - 1600w x 900d x 740h	£893	£1,286



KR20DRH

Kassini Fixed Height 'D' Ended Desk

• 25mm top panel. • Horizontal and vertical wire management as standard.

	MFC	Veneer (3 Week Lead Time)
KR22DLH - 2200w x 800d x 740h	£972	£1,407
KR22DRH - 2200w x 800d x 740h	£972	£1,407
KR20DLH - 2000w x 800d x 740h	£955	£1,382
KR20DRH - 2000w x 800d x 740h	£955	£1,382



KRE19RH

Kassini Fixed Height Radius Executive Desk

• 25mm top panel. • Horizontal and vertical wire management as standard.

	MFC	Veneer (3 Week Lead Time)
KRE19LH - 1900w x 1000d x 740h	£917	£1,325
KRE19RH - 1900w x 1000d x 740h	£917	£1,325



KC16RH

Kassini Fixed Height Crescent Workstation

• 25mm top panel. • Horizontal and vertical wire management as standard. • 600mm return.

	MFC	Veneer (3 Week Lead Time)
KC18LH - 1800w x 1200d x 740h	£978	£1,419
KC18RH - 1800w x 1200d x 740h	£978	£1,419
KC16LH - 1600w x 1200d x 740h	£939	£1,361
KC16RH - 1600w x 1200d x 740h	£939	£1,361
KC14LH - 1400w x 1200d x 740h	£913	£1,312
KC14RH - 1400w x 1200d x 740h	£913	£1,312

Kassini Fixed Height Workstations

Lead Time: Standard (All products are manufactured to order and when 'Standard Lead Time' is quoted (7 – 10 days), this may vary dependant on volume ordered, factory capacity and distribution requirements at the time of ordering. For more information please contact your Dealer Business Manager or the Customer Services Team for clarification.)

Wood: Available in MFC (Ash, Autumn Cherry, Beech, Chester Oak, English Walnut, Grey, Grey Nebraska Oak, Laurentii Wenge, Natural Nebraska Oak and White)
Top Panel Edge Detail available on 25mm White MFC (Wenge and Black - Add £32 Retail Per Top) (Plywood - Add £42 Retail Per Top)
Available in Veneer (Oak and Walnut) on a 3 Week Lead Time

Metalwork: Available in Silver RAL 9006 (Standard), Black Graphite RAL 9004, White RAL 9003 and Chrome Effect (Add 15%)



KCB18RH

Kassini Fixed Height Bow Fronted Crescent Workstation

- 25mm top panel.
- Horizontal and vertical wire management as standard.
- 600mm return.

KCB18LH - 1800w x 1300d x 740h

KCB18RH - 1800w x 1300d x 740h

MFC

**Veneer
(3 Week
Lead Time)**

£1,235

£1,235

£1,783

£1,783



KRC19RH

Kassini Fixed Height Radius Crescent Workstation

- 25mm top panel.
- Horizontal and vertical wire management as standard.
- 600mm return.

KRC19LH - 1900w x 1200d x 740h

KRC19RH - 1900w x 1200d x 740h

MFC

**Veneer
(3 Week
Lead Time)**

£1,235

£1,235

£1,783

£1,783

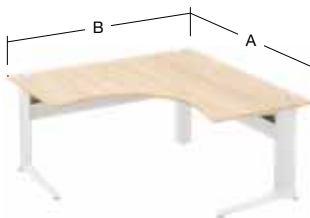

KSC16A

Kassini Fixed Height Symmetrical Crescent Workstation

- 25mm top panel.
- Horizontal and vertical wire management as standard.
- 2x 800mm ends.
- The grain direction is shown as 'A' and 'B'.

KSC18A - 1800w x 1800d x 740h

KSC18B - 1800w x 1800d x 740h

KSC16A - 1600w x 1600d x 740h

KSC16B - 1600w x 1600d x 740h

MFC

**Veneer
(3 Week
Lead Time)**

£1,295

£1,295

£1,215

£1,215

£1,876

£1,876

£1,761

£1,761

Kassini Fixed Height Workstations

Lead Time: Standard (All products are manufactured to order and when 'Standard Lead Time' is quoted (7 – 10 days), this may vary dependant on volume ordered, factory capacity and distribution requirements at the time of ordering. For more information please contact your Dealer Business Manager or the Customer Services Team for clarification.)

Wood: Available in MFC (Ash, Autumn Cherry, Beech, Chester Oak, English Walnut, Grey, Grey Nebraska Oak, Laurentii Wenge, Natural Nebraska Oak and White)
Top Panel Edge Detail available on 25mm White MFC (Wenge and Black - Add £32 Retail Per Top) (Plywood - Add £42 Retail Per Top)
Available in Veneer (Oak and Walnut) on a 3 Week Lead Time

Metalwork: Available in Silver RAL 9006 (Standard), Black Graphite RAL 9004, White RAL 9003 and Chrome Effect (Add 15%)



KW16RH

Kassini Fixed Height Single Wave Desk

- 25mm top panel. • Horizontal and vertical wire management as standard.

	MFC	Veneer (3 Week Lead Time)
KW18LH - 1800w x 1000-800d x 740h	£794	£1,146
KW18RH - 1800w x 1000-800d x 740h	£794	£1,146
KW16LH - 1600w x 1000-800d x 740h	£766	£1,107
KW16RH - 1600w x 1000-800d x 740h	£766	£1,107
KW14LH - 1400w x 1000-800d x 740h	£739	£1,073
KW14RH - 1400w x 1000-800d x 740h	£739	£1,073
KW12LH - 1200w x 1000-800d x 740h	£708	£1,024
KW12RH - 1200w x 1000-800d x 740h	£708	£1,024
KW18/6LH - 1800w x 800-600d x 740h	£755	£1,093
KW18/6RH - 1800w x 800-600d x 740h	£755	£1,093
KW16/6LH - 1600w x 800-600d x 740h	£731	£1,055
KW16/6RH - 1600w x 800-600d x 740h	£731	£1,055
KW14/6LH - 1400w x 800-600d x 740h	£704	£1,022
KW14/6RH - 1400w x 800-600d x 740h	£704	£1,022
KW12/6LH - 1200w x 800-600d x 740h	£676	£976
KW12/6RH - 1200w x 800-600d x 740h	£676	£976



KDW16/9

Kassini Fixed Height Double Wave Desk

- 25mm top panel. • Horizontal and vertical wire management as standard.

	MFC	Veneer (3 Week Lead Time)
KDW18/9 - 800d Centre - 1800w x 900d x 740h	£836	£1,187
KDW16/9 - 800d Centre - 1600w x 900d x 740h	£807	£1,150



K120

Kassini Fixed Height 120 Degree Workstation

- 25mm top panel. • Can be configured as a singular workstation or in modules of 3, 6, 9 etc.
- Horizontal and vertical wire management as standard.

	MFC	Veneer (3 Week Lead Time)
K120 - 2078w (extreme) x 800d x 740h	£972	£1,407
K120/6 - 1732w (extreme) x 600d x 740h	£912	£1,266



KK20

Kassini Fixed Height Kidney Desk

- 25mm top panel. • Horizontal and vertical wire management as standard.

	MFC	Veneer (3 Week Lead Time)
KK20 - 2000w (extreme) x 800d x 740h	£972	£1,407



KRR18

Kassini Fixed Height Radius Reception Desk

- 25mm top panel. • Horizontal and vertical wire management as standard.

	MFC	Veneer (3 Week Lead Time)
KRR20 - 2000w (extreme) x 800d x 740h	£1,187	£1,723
KRR18 - 1800w (extreme) x 800d x 740h	£1,071	£1,550

Kassini Fixed Height Workstations, Returns and Extensions

Lead Time: Standard (All products are manufactured to order and when 'Standard Lead Time' is quoted (7 – 10 days), this may vary dependant on volume ordered, factory capacity and distribution requirements at the time of ordering. For more information please contact your Dealer Business Manager or the Customer Services Team for clarification.)

Wood: Available in MFC (Ash, Autumn Cherry, Beech, Chester Oak, English Walnut, Grey, Grey Nebraska Oak, Laurentii Wenge, Natural Nebraska Oak and White)
Top Panel Edge Detail available on 25mm White MFC (Wenge and Black - Add £32 Retail Per Top) (Plywood - Add £42 Retail Per Top)
Available in Veneer (Oak and Walnut) on a 3 Week Lead Time

Metalwork: Available in Silver RAL 9006 (Standard), Black Graphite RAL 9004, White RAL 9003 and Chrome Effect (Add 15%)



KRDRH

Kassini Fixed Height Reception Desk

- 2x 25mm top panels. • 850mm and 600mm ends are slightly curved.
- Horizontal and vertical wire management as standard.

	MFC	Veneer (3 Week Lead Time)
KRDLH - 1850w (extreme) x 1800d x 740h	£1,776	£2,562
KRDRH - 1850w (extreme) x 1800d x 740h	£1,776	£2,562



KLW8/6

Kassini Fixed Height Linking Workstation

- 25mm top panel. • Links 800mm and 600mm deep desks.
- Horizontal and vertical wire management as standard.

	MFC	Veneer (3 Week Lead Time)
KLW8/6 - 1225w x 1225d x 740h	£858	£1,241
KLW8/4 - 1083w x 1083d x 740h	£828	£1,198
KLW6 - 1025w x 1025d x 740h	£799	£1,153



KSR10/6RH

Kassini Fixed Height Secretarial Return for Rectangular Desks

- 25mm top panel. • Horizontal and vertical wire management as standard.
- Compatible with rectangular, bow fronted rectangular and 'D' ended desks only.

	MFC	Veneer (3 Week Lead Time)
KSR10/6LH - 1000w x 600d x 740h	£423	£611
KSR10/6RH - 1000w x 600d x 740h	£423	£611



KSR10/6CRH

Kassini Fixed Height Secretarial Return for Crescent Workstations

- 25mm top panel. • Horizontal and vertical wire management as standard.
- Compatible with crescent, bow fronted crescent and radius crescent workstations only.

	MFC	Veneer (3 Week Lead Time)
KSR10/6CLH - 1000w x 600d x 740h	£423	£611
KSR10/6CRH - 1000w x 600d x 740h	£423	£611



KSCMT16

Kassini Meeting Extension

- 25mm top panel. • Complete with 120mm diameter support leg on 300mm diameter base.

	MFC	Veneer (3 Week Lead Time)
KSCMT16 - For 1600d Ends - 1600w x 660d x 740h	£712	£1,034
KSCMT12 - For 1200d Ends - 1200w x 600d x 740h	£688	£991
KSCMT8 - For 800d Ends - 800w x 600d x 740h	£639	£928
KSCMT120 - For K120 - 1600w x 660d x 740h	£712	£1,034
KDWSCMT18 - For Kassini Double Wave Desks - 1800w x 800d x 740h	£844	£1,224

Kassini Accessories

Lead Time: Standard (All products are manufactured to order and when 'Standard Lead Time' is quoted (7 – 10 days), this may vary dependant on volume ordered, factory capacity and distribution requirements at the time of ordering. For more information please contact your Dealer Business Manager or the Customer Services Team for clarification.)



F2LMPBT

Showing Bolt Through Version

Flex Monitor Arm

- Post mounted monitor arm with 2x folding links.

F2LMP - Silver Clamp on Desk Fixing
F2LMP/W - White Clamp on Desk Fixing
 • Manual Post Height Adjustment

F2LGP - Silver Clamp on Desk Fixing
F2LGP/W - White Clamp on Desk Fixing
 • Front End Height Adjustment

Price

£180

£180

£227

£227

Kassini Accessory Compatibility

- **BLACK** - Compatible
- **BLUE** - Conflict when using screens

	Screens Desk Mounted Screens, page 272-289	Power and Data Modules Kaspa and Prime, page 309 Boardroom, Conus and Peak, page 310-312 Escalate, page 312 Wireless Charging Unit, page 313 Port Hole and Pix, page 314 Pluto and Inca, page 315 Flex and Capsule, page 316-317 Plaza and Boost, page 318 Wieland Socket Boxes, page 319	Monitor Arms M2, page 320 Flex, page 320-322 Ascend, page 321-322 Ollin and Flo, page 321-322 M8, page 322
Workstations - Height Adjustable Rectangular	●	●	●
Workstations - Height Adjustable Bow Fronted Rectangular	●	●	●
Workstations - Height Adjustable D Ended	●	●	●
Workstations - Height Adjustable Crescent	●	●	●
Workstations - Height Adjustable Bow Fronted Crescent	●	●	●
Workstations - Height Adjustable Single Wave	●	●	●
Workstations - Height Adjustable 120 Degree	●	●	●
Workstations - Fixed Height Rectangular	●	●	●
Workstations - Fixed Height Bow Fronted Rectangular	●	●	●
Workstations - Fixed Height 'D' Ended	●	●	●
Workstations - Fixed Height Radius Executive	●	●	●
Workstations - Fixed Height Crescent	●	●	●
Workstations - Fixed Height Bow Fronted Crescent	●	●	●
Workstations - Fixed Height Radius Crescent	●	●	●
Workstations - Fixed Height Symmetrical Crescent	●	●	●
Workstations - Fixed Height Single Wave	●	●	●
Workstations - Fixed Height Double Wave	●	●	●
Workstations - Fixed Height 120 Degree	●	●	●
Workstations - Fixed Height Kidney	●	●	●
Workstations - Fixed Height Radius Reception	●	●	●
Workstations - Fixed Height Reception	●	●	●
Workstations - Fixed Height Linking	●	●	●
Extensions - Secretarial Return	●	●	●
Extensions - Meeting	●	●	●

Optima Plus Manual Sit / Sit Adjustable and Fixed Height Workstations



The Optima Plus range offers a myriad of footprints to suit the demands of the majority of applications. The unique design of Optima Plus and the minimal number of components required, ensures a swift and efficient assembly process, reducing installation costs. The cantilever leg frame is supported by an integral MFC modesty panel that can be colour matched to the work surface or supplied in a contrast finish. Within the range, a height adjustable workstation offers height adjustment from 650mm to 850mm via a manual rotating handle, that is easily operated by the user and when not in use, discreetly retracts within the frame.

Optima Plus Height Adjustable Workstations

Lead Time: Standard (All products are manufactured to order and when 'Standard Lead Time' is quoted (7 – 10 days), this may vary dependant on volume ordered, factory capacity and distribution requirements at the time of ordering. For more information please contact your Dealer Business Manager or the Customer Services Team for clarification.)

Wood: Available in MFC (Ash, Autumn Cherry, Beech, Chester Oak, English Walnut, Grey, Grey Nebraska Oak, Laurentii Wenge, Natural Nebraska Oak and White)
Top Panel Edge Detail available on 25mm White MFC (Wenge and Black - Add £32 Retail Per Top) (Plywood - Add £42 Retail Per Top)
Available in Veneer (Oak and Walnut) on a 3 Week Lead Time

Metalwork: Available in Silver RAL 9006 (Standard), Black Graphite RAL 9004, White RAL 9003 and Chrome Effect (Add 15%)



Optima Plus Height Adjustable Rectangular Desk

• 25mm top panel. • Sit / sit height adjustment of 650mm-850mm via crank handle.

		MFC	Veneer (3 Week Lead Time)
OPR18/HA	- 1800w x 800d x 650-850h	£1,181	£1,486
OPR16/HA	- 1600w x 800d x 650-850h	£1,150	£1,452
OPR14/HA	- 1400w x 800d x 650-850h	£1,137	£1,425
OPR12/HA	- 1200w x 800d x 650-850h	£1,110	£1,399
OPR10/HA	- 1000w x 800d x 650-850h	£1,090	£1,363
OPR8/HA	- 800w x 800d x 650-850h	£1,042	£1,290
OPR18/6/HA	- 1800w x 600d x 650-850h	£1,150	£1,452
OPR16/6/HA	- 1600w x 600d x 650-850h	£1,138	£1,431
OPR14/6/HA	- 1400w x 600d x 650-850h	£1,119	£1,405
OPR12/6/HA	- 1200w x 600d x 650-850h	£1,101	£1,378
OPR10/6/HA	- 1000w x 600d x 650-850h	£1,079	£1,345
OPR8/6/HA	- 800w x 600d x 650-850h	£1,036	£1,276



Optima Plus Height Adjustable Bow Fronted Rectangular Desk

• 25mm top panel. • Sit / sit height adjustment of 650mm-850mm via crank handle.

		MFC	Veneer (3 Week Lead Time)
OPRB18/HA	- 1800w x 900d x 650-850h	£1,434	£1,857
OPRB16/HA	- 1600w x 900d x 650-850h	£1,407	£1,822



Optima Plus Height Adjustable 'D' Ended Desk

• 25mm top panel. • Sit / sit height adjustment of 650mm-850mm via crank handle.

		MFC	Veneer (3 Week Lead Time)
OPR22DLH/HA	- 2200w x 800d x 650-850h	£1,486	£1,941
OPR22DRH/HA	- 2200w x 800d x 650-850h	£1,486	£1,941
OPR20DLH/HA	- 2000w x 800d x 650-850h	£1,471	£1,916
OPR20DRH/HA	- 2000w x 800d x 650-850h	£1,471	£1,916

Optima Plus Height Adjustable Workstations and Accessories

Lead Time: Standard (All products are manufactured to order and when 'Standard Lead Time' is quoted (7 – 10 days), this may vary dependant on volume ordered, factory capacity and distribution requirements at the time of ordering. For more information please contact your Dealer Business Manager or the Customer Services Team for clarification.)

Wood: Available in MFC (Ash, Autumn Cherry, Beech, Chester Oak, English Walnut, Grey, Grey Nebraska Oak, Laurentii Wenge, Natural Nebraska Oak and White)
Top Panel Edge Detail available on 25mm White MFC (Wenge and Black - Add £32 Retail Per Top) (Plywood - Add £42 Retail Per Top)
Available in Veneer (Oak and Walnut) on a 3 Week Lead Time

Metalwork: Available in Silver RAL 9006 (Standard), Black Graphite RAL 9004, White RAL 9003 and Chrome Effect (Add 15%)



OPC16RH/HA

Optima Plus Height Adjustable Crescent Workstation

- 25mm top panel.
- Sit / sit height adjustment of 650mm-850mm via crank handle.
- 600mm return.

	MFC	Veneer (3 Week Lead Time)
OPC18LH/HA - 1800w x 1200d x 650-850h	£1,655	£2,116
OPC18RH/HA - 1800w x 1200d x 650-850h	£1,655	£2,116
OPC16LH/HA - 1600w x 1200d x 650-850h	£1,613	£2,059
OPC16RH/HA - 1600w x 1200d x 650-850h	£1,613	£2,059
OPC14LH/HA - 1400w x 1200d x 650-850h	£1,587	£2,009
OPC14RH/HA - 1400w x 1200d x 650-850h	£1,587	£2,009



OPCB18RH/HA

Optima Plus Height Adjustable Bow Fronted Crescent Workstation

- 25mm top panel.
- Sit / sit height adjustment of 650mm-850mm via crank handle.
- 600mm return.

	MFC	Veneer (3 Week Lead Time)
OPCB18LH/HA - 1800w x 1300d x 650-850h	£1,909	£2,480
OPCB18RH/HA - 1800w x 1300d x 650-850h	£1,909	£2,480



OPW16RH/HA

Optima Plus Height Adjustable Single Wave Desk

- 25mm top panel.
- Sit / sit height adjustment of 650mm-850mm via crank handle.

	MFC	Veneer (3 Week Lead Time)
OPW18LH/HA - 1800w x 1000-800d x 650-850h	£1,311	£1,843
OPW18RH/HA - 1800w x 1000-800d x 650-850h	£1,311	£1,843
OPW16LH/HA - 1600w x 1000-800d x 650-850h	£1,282	£1,806
OPW16RH/HA - 1600w x 1000-800d x 650-850h	£1,282	£1,806
OPW14LH/HA - 1400w x 1000-800d x 650-850h	£1,256	£1,770
OPW14RH/HA - 1400w x 1000-800d x 650-850h	£1,256	£1,770
OPW12LH/HA - 1200w x 1000-800d x 650-850h	£1,224	£1,723
OPW12RH/HA - 1200w x 1000-800d x 650-850h	£1,224	£1,723
OPW18/6LH/HA - 1800w x 800-600d x 650-850h	£1,272	£1,791
OPW18/6RH/HA - 1800w x 800-600d x 650-850h	£1,272	£1,791
OPW16/6LH/HA - 1600w x 800-600d x 650-850h	£1,247	£1,754
OPW16/6RH/HA - 1600w x 800-600d x 650-850h	£1,247	£1,754
OPW14/6LH/HA - 1400w x 800-600d x 650-850h	£1,220	£1,720
OPW14/6RH/HA - 1400w x 800-600d x 650-850h	£1,220	£1,720
OPW12/6LH/HA - 1200w x 800-600d x 650-850h	£1,193	£1,674
OPW12/6RH/HA - 1200w x 800-600d x 650-850h	£1,193	£1,674



OP120/HA

Optima Plus Height Adjustable 120 Degree Workstation

- 25mm top panel.
- Sit / sit height adjustment of 650mm-850mm via crank handle.
- Can be configured as a singular workstation or in modules of 3, 6, 9 etc.

	MFC	Veneer (3 Week Lead Time)
OP120/HA - 2078w (extreme) x 800d x 650-850h	£1,646	£2,105
OP120/6/HA - 1732w (extreme) x 600d x 650-850h	£1,586	£1,963



SCR/S - SCR/B - SCR/W

Slinky Cable Riser

- Suitable for all desking ranges.

	Price
SCR/S - Silver	£59
SCR/B - Black	£59
SCR/W - White	£59

Optima Plus Fixed Height Workstations

Lead Time: Standard (All products are manufactured to order and when 'Standard Lead Time' is quoted (7 – 10 days), this may vary dependant on volume ordered, factory capacity and distribution requirements at the time of ordering. For more information please contact your Dealer Business Manager or the Customer Services Team for clarification.)

Wood: Available in MFC (Ash, Autumn Cherry, Beech, Chester Oak, English Walnut, Grey, Grey Nebraska Oak, Laurentii Wenge, Natural Nebraska Oak and White)
Top Panel Edge Detail available on 25mm White MFC (Wenge and Black - Add £32 Retail Per Top) (Plywood - Add £42 Retail Per Top)
Available in Veneer (Oak and Walnut) on a 3 Week Lead Time

Metalwork: Available in Silver RAL 9006 (Standard), Black Graphite RAL 9004, White RAL 9003 and Chrome Effect (Add 15%)



OPR16

Optima Plus Fixed Height Rectangular Desk

• 25mm top panel. • Wire managed legs as standard.

	MFC	Veneer (3 Week Lead Time)
OPR18 - 1800w x 800d x 740h	£588	£854
OPR16 - 1600w x 800d x 740h	£567	£823
OPR14 - 1400w x 800d x 740h	£550	£795
OPR12 - 1200w x 800d x 740h	£534	£769
OPR10 - 1000w x 800d x 740h	£513	£745
OPR8 - 800w x 800d x 740h	£493	£714
OPR18/6 - 1800w x 600d x 740h	£567	£823
OPR16/6 - 1600w x 600d x 740h	£554	£800
OPR14/6 - 1400w x 600d x 740h	£537	£775
OPR12/6 - 1200w x 600d x 740h	£524	£752
OPR10/6 - 1000w x 600d x 740h	£504	£725
OPR8/6 - 800w x 600d x 740h	£488	£708



OPRB16

Optima Plus Fixed Height Bow Fronted Rectangular Desk

• 25mm top panel. • Wire managed legs as standard.

	MFC	Veneer (3 Week Lead Time)
OPRB18 - 1800w x 900d x 740h	£818	£1,183
OPRB16 - 1600w x 900d x 740h	£797	£1,150



OPR20DRH

Optima Plus Fixed Height 'D' Ended Desk

• 25mm top panel. • Wire managed legs as standard.

	MFC	Veneer (3 Week Lead Time)
OPR22DLH - 2200w x 800d x 740h	£869	£1,256
OPR22DRH - 2200w x 800d x 740h	£869	£1,256
OPR20DLH - 2000w x 800d x 740h	£851	£1,233
OPR20DRH - 2000w x 800d x 740h	£851	£1,233



OPRE19RH

Optima Plus Fixed Height Radius Executive Desk

• 25mm top panel. • Wire managed legs as standard.

	MFC	Veneer (3 Week Lead Time)
OPRE19LH - 1900w x 1000d x 740h	£818	£1,183
OPRE19RH - 1900w x 1000d x 740h	£818	£1,183



OPC16RH

Optima Plus Fixed Height Crescent Workstation

• 25mm top panel. • Wire managed legs as standard. • 600mm return.

	MFC	Veneer (3 Week Lead Time)
OPC18LH - 1800w x 1200d x 740h	£873	£1,268
OPC18RH - 1800w x 1200d x 740h	£873	£1,268
OPC16LH - 1600w x 1200d x 740h	£838	£1,215
OPC16RH - 1600w x 1200d x 740h	£838	£1,215
OPC14LH - 1400w x 1200d x 740h	£811	£1,171
OPC14RH - 1400w x 1200d x 740h	£811	£1,171

Optima Plus Fixed Height Workstations

Lead Time: Standard (All products are manufactured to order and when 'Standard Lead Time' is quoted (7 – 10 days), this may vary dependant on volume ordered, factory capacity and distribution requirements at the time of ordering. For more information please contact your Dealer Business Manager or the Customer Services Team for clarification.)

Wood: Available in MFC (Ash, Autumn Cherry, Beech, Chester Oak, English Walnut, Grey, Grey Nebraska Oak, Laurentii Wenge, Natural Nebraska Oak and White)
Top Panel Edge Detail available on 25mm White MFC (Wenge and Black - Add £32 Retail Per Top) (Plywood - Add £42 Retail Per Top)
Available in Veneer (Oak and Walnut) on a 3 Week Lead Time

Metalwork: Available in Silver RAL 9006 (Standard), Black Graphite RAL 9004, White RAL 9003 and Chrome Effect (Add 15%)



OPCB18RH

Optima Plus Fixed Height Bow Fronted Crescent Workstation

- 25mm top panel. • Wire managed legs as standard. • 600mm return.

	MFC	Veneer (3 Week Lead Time)
OPCB18LH - 1800w x 1300d x 740h	£1,101	£1,591
OPCB18RH - 1800w x 1300d x 740h	£1,101	£1,591



OPRC19RH

Optima Plus Fixed Height Radius Crescent Workstation

- 25mm top panel. • Wire managed legs as standard. • 600mm return.

	MFC	Veneer (3 Week Lead Time)
OPRC19LH - 1900w x 1200d x 740h	£1,101	£1,591
OPRC19RH - 1900w x 1200d x 740h	£1,101	£1,591

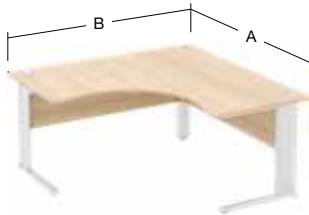

OPSC16A

Optima Plus Fixed Height Symmetrical Crescent Workstation

- 25mm top panel. • Wire managed legs as standard. • 2x 800mm ends.
- The grain direction is shown as 'A' and 'B'.

	MFC	Veneer (3 Week Lead Time)
OPSC18A - 1800w x 1800d x 740h	£1,101	£1,591
OPSC18B - 1800w x 1800d x 740h	£1,101	£1,591
OPSC16A - 1600w x 1600d x 740h	£1,035	£1,496
OPSC16B - 1600w x 1600d x 740h	£1,035	£1,496



OPW16RH

Optima Plus Fixed Height Single Wave Desk

- 25mm top panel. • Wire managed legs as standard.

	MFC	Veneer (3 Week Lead Time)
OPW18LH - 1800w x 1000-800d x 740h	£707	£1,023
OPW18RH - 1800w x 1000-800d x 740h	£707	£1,023
OPW16LH - 1600w x 1000-800d x 740h	£687	£987
OPW16RH - 1600w x 1000-800d x 740h	£687	£987
OPW14LH - 1400w x 1000-800d x 740h	£663	£957
OPW14RH - 1400w x 1000-800d x 740h	£663	£957
OPW12LH - 1200w x 1000-800d x 740h	£632	£915
OPW12RH - 1200w x 1000-800d x 740h	£632	£915
OPW18/6LH - 1800w x 800-600d x 740h	£674	£975
OPW18/6RH - 1800w x 800-600d x 740h	£674	£975
OPW16/6LH - 1600w x 800-600d x 740h	£653	£940
OPW16/6RH - 1600w x 800-600d x 740h	£653	£940
OPW14/6LH - 1400w x 800-600d x 740h	£631	£912
OPW14/6RH - 1400w x 800-600d x 740h	£631	£912
OPW12/6LH - 1200w x 800-600d x 740h	£602	£869
OPW12/6RH - 1200w x 800-600d x 740h	£602	£869



OPDW16/9

Optima Plus Fixed Height Double Wave Desk

- 25mm top panel. • Wire managed legs as standard.

	MFC	Veneer (3 Week Lead Time)
OPDW18/10 - 900d Centre - 1800w x 1000d x 740h	£770	£1,087
OPDW16/10 - 900d Centre - 1600w x 1000d x 740h	£744	£1,053
OPDW18/9 - 800d Centre - 1800w x 900d x 740h	£729	£1,042
OPDW16/9 - 800d Centre - 1600w x 900d x 740h	£703	£1,012

Optima Plus Fixed Height Workstations

Lead Time: Standard (All products are manufactured to order and when 'Standard Lead Time' is quoted (7 – 10 days), this may vary dependant on volume ordered, factory capacity and distribution requirements at the time of ordering. For more information please contact your Dealer Business Manager or the Customer Services Team for clarification.)

Wood: Available in MFC (Ash, Autumn Cherry, Beech, Chester Oak, English Walnut, Grey, Grey Nebraska Oak, Laurentii Wenge, Natural Nebraska Oak and White)
Top Panel Edge Detail available on 25mm White MFC (Wenge and Black - Add £32 Retail Per Top) (Plywood - Add £42 Retail Per Top)
Available in Veneer (Oak and Walnut) on a 3 Week Lead Time

Metalwork: Available in Silver RAL 9006 (Standard), Black Graphite RAL 9004, White RAL 9003 and Chrome Effect (Add 15%)



OP120

Optima Plus Fixed Height 120 Degree Workstation

- 25mm top panel.
- Can be configured as a singular workstation or in modules of 3, 6, 9 etc.
- Wire managed legs as standard.

	MFC	Veneer (3 Week Lead Time)
OP120 - 2078w (extreme) x 800d x 740h	£869	£1,256
OP120/6 - 1732w (extreme) x 600d x 740h	£778	£1,068



OPK20

Optima Plus Fixed Height Kidney Desk

- 25mm top panel.
- Wire managed legs as standard.

	MFC	Veneer (3 Week Lead Time)
OPK20 - 2000w (extreme) x 800d x 740h	£869	£1,256



OPRR18

Optima Plus Fixed Height Radius Reception Desk

- 25mm top panel.
- Wire managed legs as standard.

	MFC	Veneer (3 Week Lead Time)
OPRR20 - 2000w (extreme) x 800d x 740h	£1,042	£1,621
OPRR18 - 1800w (extreme) x 800d x 740h	£942	£1,465



OPRDRH

Optima Plus Fixed Height Reception Desk

- 2x 25mm top panels.
- 850mm and 600mm ends are slightly curved.
- Wire managed legs as standard.

	MFC	Veneer (3 Week Lead Time)
OPRDLH - 1850w (extreme) x 1800d x 740h	£1,584	£2,289
OPRDRH - 1850w (extreme) x 1800d x 740h	£1,584	£2,289



OPLW8/6

Optima Plus Fixed Height Linking Workstation

- 25mm top panel.
- Links 800mm and 600mm deep desks.
- Wire managed legs as standard.

	MFC	Veneer (3 Week Lead Time)
OPLW8/6 - 1225w x 1225d x 740h	£766	£1,109
OPLW8/4 - 1083w x 1083d x 740h	£739	£1,072
OPLW6 - 1025w x 1025d x 740h	£712	£1,030



OPSR10/6RH

Optima Plus Fixed Height Secretarial Return for Rectangular Desks

- 25mm top panel.
- Wire managed legs as standard.
- Compatible with rectangular, bow fronted rectangular and 'D' ended desks only.

	MFC	Veneer (3 Week Lead Time)
OPSR10/6LH - 1000w x 600d x 740h	£376	£542
OPSR10/6RH - 1000w x 600d x 740h	£376	£542

Optima Plus Fixed Height Workstations, Returns and Extensions

Lead Time: Standard (All products are manufactured to order and when 'Standard Lead Time' is quoted (7 – 10 days), this may vary dependant on volume ordered, factory capacity and distribution requirements at the time of ordering. For more information please contact your Dealer Business Manager or the Customer Services Team for clarification.)

Wood: Available in MFC (Ash, Autumn Cherry, Beech, Chester Oak, English Walnut, Grey, Grey Nebraska Oak, Laurentii Wenge, Natural Nebraska Oak and White)
Top Panel Edge Detail available on 25mm White MFC (Wenge and Black - Add £32 Retail Per Top) (Plywood - Add £42 Retail Per Top)
Available in Veneer (Oak and Walnut) on a 3 Week Lead Time

Metalwork: Available in Silver RAL 9006 (Standard), Black Graphite RAL 9004, White RAL 9003 and Chrome Effect (Add 15%)



OPSCMT16

Optima Plus Meeting Extension

- 25mm top panel.
- Complete with 120mm diameter support leg on 300mm diameter base.

			MFC	Veneer (3 Week Lead Time)
OPSCMT16	- For 1600d Ends	- 1600w x 660d x 740h	£712	£1,034
OPSCMT12	- For 1200d Ends	- 1200w x 600d x 740h	£688	£991
OPSCMT8	- For 800d Ends	- 800w x 600d x 740h	£639	£929
OPSCMT120	- For OP120	- 1600w x 660d x 740h	£712	£1,034
OPDWSCMT18	- For 900d Double Wave Desks	- 1800w x 800d x 740h	£828	£1,209



OPDWSCMT

Optima Plus Meeting Extension

- 25mm top panel.
- Complete with 2x 60mm diameter support legs.

			MFC	Veneer (3 Week Lead Time)
OPDWSCMT	- For 1000d Double Wave Desks	- 2000w x 800d x 740h	£844	£1,224



OPLU90R

Optima Plus Curved Linking Extension

- 25mm top panel.
- Links 800mm deep workstations.

			MFC	Veneer (3 Week Lead Time)
OPLU90R	- 800w x 800d x 740h		£237	£343



OPLU8L

Optima Plus Square Linking Extension

- 25mm top panel.
- Links 800mm deep workstations.

			MFC	Veneer (3 Week Lead Time)
OPLU8L	- 800w x 800d x 740h		£237	£343



OPCPU/W and OPCPU

Optima Plus CPU Holder

- Includes Optima Plus mounting kit.
- Adjustable CPU holder for PC towers.
- Rotates a full 360 degrees for complete access to cables and ports.

			Price
OPCPU	- Black Trim		£186
OPCPU/W	- White Trim		£186



F2LMPBT

Flex Monitor Arm

- Post mounted monitor arm with 2x folding links.

			Price
F2LMP	- Silver Clamp on Desk Fixing		£180
F2LMP/W	- White Clamp on Desk Fixing		£180
	• Manual Post Height Adjustment		
F2LGP	- Silver Clamp on Desk Fixing		£227
F2LGP/W	- White Clamp on Desk Fixing		£227
	• Front End Height Adjustment		

Showing Bolt Through Version

Optima Plus Accessories

Lead Time: Standard (All products are manufactured to order and when 'Standard Lead Time' is quoted (7 – 10 days), this may vary dependant on volume ordered, factory capacity and distribution requirements at the time of ordering. For more information please contact your Dealer Business Manager or the Customer Services Team for clarification.)

Metalwork: Available in Silver RAL 9006 (Standard), Black Graphite RAL 9004, White RAL 9003 and Chrome Effect (Add 15%)



OF9
Illustrated in red

Optima Plus Cable Tray

- Cable trays are 100mm deep and 110mm high.
- For compatible desks, see below.

Model	Width	Price
OF11	1475w	£76
OF10	1385w	£73
OF9	1275w	£70
OF8	1185w	£64
OF7	1075w	£61
OF6	970w	£59
OF5	900w	£58
OF4	860w	£57
OF3	755w	£55
OF2	670w	£54
OF1	500w	£49

Metalwork

Optima Plus Cable Tray Compatibility

- Rectangular - OPR18 (+/6) (+HA)
- Rectangular - OPR16 (+/6) (+HA)
- Rectangular - OPR14 (+/6) (+HA)
- Rectangular - OPR12 (+/6) (+HA)
- Rectangular - OPR10 (+/6) (+HA)
- Rectangular - OPR8 (+/6) (+HA)
- Bow Fronted Rectangular - OPRB18 (+HA)
- Bow Fronted Rectangular - OPRB16 (+HA)
- 'D' Ended - OPR22D (LH/RH) (+HA)
- 'D' Ended - OPR20D (LH/RH) (+HA)
- Radius Executive - OPRE19 (LH/RH)
- Crescent - OPC18 (LH/RH) (+HA)
- Crescent - OPC16 (LH/RH) (+HA)
- Crescent - OPC14 (LH/RH) (+HA)
- Bow Fronted Crescent - OPCB18 (LH/RH) (+HA)
- Radius Crescent - OPRC19 (LH/RH)
- Symmetrical Crescent - OPSC18 (A/B)
- Symmetrical Crescent - OPSC16 (A/B)
- Single Wave - OPW18 (LH/RH) (+/6) (+HA)
- Single Wave - OPW16 (LH/RH) (+/6) (+HA)
- Single Wave - OPW14 (LH/RH) (+/6) (+HA)
- Single Wave - OPW12 (LH/RH) (+/6) (+HA)
- Double Wave - OPDW18 (+/10) (+/9)
- Double Wave - OPDW16 (+/10) (+/9)
- 120 Degree - OP120 (+HA)
- 120 Degree - OP120/6 (+HA)
- Kidney - OPK20
- Radius Reception - OPRR20
- Radius Reception - OPRR18
- Reception - OPRD (LH/RH)
- Linking - OPLW8/6 (+/4)
- Linking - OPLW6
- Secretarial Return - OPSR (LH/RH)

Optima Plus Cable Tray

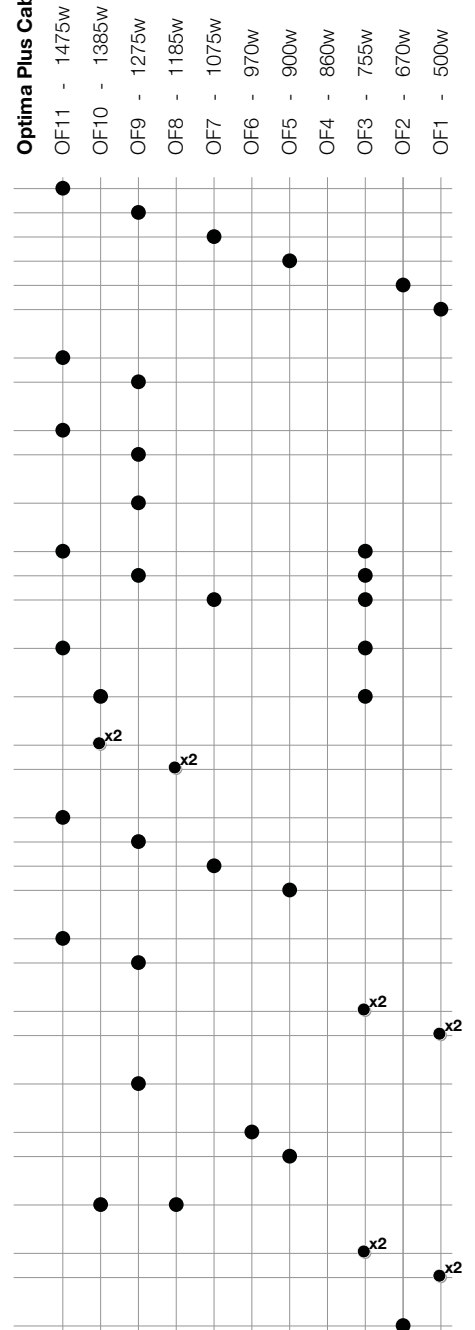

Optima Plus Conference / Meeting Tables

Lead Time: Standard (All products are manufactured to order and when 'Standard Lead Time' is quoted (7 – 10 days), this may vary dependant on volume ordered, factory capacity and distribution requirements at the time of ordering. For more information please contact your Dealer Business Manager or the Customer Services Team for clarification.)

Wood: Available in MFC (Ash, Autumn Cherry, Beech, Chester Oak, English Walnut, Grey, Grey Nebraska Oak, Laurentii Wenge, Natural Nebraska Oak and White) Top Panel Edge Detail available on 25mm White MFC (Wenge and Black - Add £32 Retail Per Top) (Plywood - Add £42 Retail Per Top) Available in Veneer (Oak and Walnut) on a 3 Week Lead Time

Metalwork: Available in Silver RAL 9006 (Standard), Black Graphite RAL 9004, White RAL 9003 and Chrome Effect (Add 15%) Also available in Blue RAL 5001, Coral RAL 2001, Green RAL 6016, Light Grey RAL 7038, Teal RAL 5018 and Yellow RAL 1021 (Add 12% for all - 2 Week Lead Time)



OPCONF2

Optima Plus Double 'D' Ended Conference Table

• 25mm top panel. • 'I' frame leg configuration with modesty panel.

OPCONF3 - 4800w x 1200d x 740h
• 2x 1700mm and 1x 1400mm Sections • Seating up to 14 People

OPCONF2 - 3400w x 1200d x 740h
• 2x 1700mm Sections • Seating up to 10 People

OPCONF1B - 2400w x 1200d x 740h
• 1x 2400mm Section • Seating up to 8 People

OPCONF1A - 2000w x 1200d x 740h
• 1x 2000mm Section • Seating up to 8 People

MFC
Veneer (3 Week Lead Time)

£2,643 £4,099

£2,068 £3,207

£1,239 £1,925

£1,034 £1,602



OPCONF1A

Optima Plus Double 'D' Ended Conference Table

• 25mm top panel. • 120mm diameter legs on 685mm diameter bases.

OPCONF1CB - 2400w x 1200d x 725h
• 1x 2400mm Section • Seating up to 8 People

OPCONF1CA - 2000w x 1200d x 725h
• 1x 2000mm Section • Seating up to 8 People

MFC
Veneer (3 Week Lead Time)

£1,239 £1,925

£1,034 £1,602



OPCONF1CA

Optima Plus Rectangular Conference Table

• 25mm top panel. • Supplied with MT01 bases.
• Wire managed base, 80mm aperture, located within the column. • 100mm square column.
• Heavy duty weighted 505mm square x 15mm deep base. • Levelling feet.

OPCONF1SB - 2400w x 1200d x 740h
• 1x 2400mm Section • Seating up to 8 People

OPCONF1SA - 2000w x 1200d x 740h
• 1x 2000mm Section • Seating up to 8 People

MFC
Veneer (3 Week Lead Time)

£1,239 £1,925

£1,034 £1,602



OPCONF1SA

Optima Plus Double 'D' Ended Meeting Table

• 25mm top panel. • 'I' frame leg configuration with modesty panel.

OPDDMT26 - 2600w x 800d x 740h

OPDDMT24 - 2400w x 800d x 740h

OPDDMT22 - 2200w x 800d x 740h

OPDDMT20 - 2000w x 800d x 740h

MFC
Veneer (3 Week Lead Time)

£906 -

£886 £1,280

£872 £1,262

£851 £1,233



OPDDMT24

Optima Plus 'D' Ended Meeting Table

• 25mm top panel. • 'I' frame leg configuration with modesty panel.

OPDMT22 - 2200w x 800d x 740h

OPDMT20 - 2000w x 800d x 740h

OPDMT18 - 1800w x 800d x 740h

OPDMT16 - 1600w x 800d x 740h

MFC
Veneer (3 Week Lead Time)

£828 £1,196

£809 £1,177

£794 £1,146

£776 £1,124



OPDMT20

Optima Plus Rectangular Meeting Table

• 25mm top panel. • 'I' frame leg configuration with modesty panel.

OPRMT18 - 1800w x 800d x 740h

OPRMT16 - 1600w x 800d x 740h

OPRMT14 - 1400w x 800d x 740h

OPRMT12 - 1200w x 800d x 740h

MFC
Veneer (3 Week Lead Time)

£626 £906

£607 £881

£593 £858

£572 £831



OPRMT16

Optima Plus Accessory Compatibility

- **BLACK** - Compatible
- **BLUE** - Conflict when using screens

	Screens	Power and Data Modules							Monitor Arms						
	Desk Mounted Screens, page 272-289	Kaspa and Prime, page 309	Boardroom, Conus and Peak, page 310-312	Escalate, page 312	Wireless Charging Unit, page 313	Port Hole and Pix, page 314	Pluto and Inca, page 315	Flex and Capsule, page 316-317	Plaza and Boost, page 318	Wieland Socket Boxes, page 319	M2, page 320	Flex, page 320-322	Ascend, page 321-322	Ollin and Flo, page 321-322	M8, page 322
Workstations - Height Adjustable Rectangular	●	●	●	●	●	●	●	●	●	●	●	●	●	●	●
Workstations - Height Adjustable Bow Fronted Rectangular	●	●	●	●	●	●	●	●	●	●	●	●	●	●	●
Workstations - Height Adjustable D Ended	●	●	●	●	●	●	●	●	●	●	●	●	●	●	●
Workstations - Height Adjustable Crescent	●	●	●	●	●	●	●	●	●	●	●	●	●	●	●
Workstations - Height Adjustable Bow Fronted Crescent	●	●	●	●	●	●	●	●	●	●	●	●	●	●	●
Workstations - Height Adjustable Single Wave	●	●	●	●	●	●	●	●	●	●	●	●	●	●	●
Workstations - Height Adjustable 120 Degree	●	●	●	●	●	●	●	●	●	●	●	●	●	●	●
Workstations - Fixed Height Rectangular	●	●	●	●	●	●	●	●	●	●	●	●	●	●	●
Workstations - Fixed Height Bow Fronted Rectangular	●	●	●	●	●	●	●	●	●	●	●	●	●	●	●
Workstations - Fixed Height 'D' Ended	●	●	●	●	●	●	●	●	●	●	●	●	●	●	●
Workstations - Fixed Height Radius Executive	●	●	●	●	●	●	●	●	●	●	●	●	●	●	●
Workstations - Fixed Height Crescent	●	●	●	●	●	●	●	●	●	●	●	●	●	●	●
Workstations - Fixed Height Bow Fronted Crescent	●	●	●	●	●	●	●	●	●	●	●	●	●	●	●
Workstations - Fixed Height Radius Crescent	●	●	●	●	●	●	●	●	●	●	●	●	●	●	●
Workstations - Fixed Height Symmetrical Crescent	●	●	●	●	●	●	●	●	●	●	●	●	●	●	●
Workstations - Fixed Height Single Wave	●	●	●	●	●	●	●	●	●	●	●	●	●	●	●
Workstations - Fixed Height Double Wave	●	●	●	●	●	●	●	●	●	●	●	●	●	●	●
Workstations - Fixed Height 120 Degree	●	●	●	●	●	●	●	●	●	●	●	●	●	●	●
Workstations - Fixed Height Kidney	●	●	●	●	●	●	●	●	●	●	●	●	●	●	●
Workstations - Fixed Height Radius Reception	●	●	●	●	●	●	●	●	●	●	●	●	●	●	●
Workstations - Fixed Height Reception	●	●	●	●	●	●	●	●	●	●	●	●	●	●	●
Workstations - Fixed Height Linking	●	●	●	●	●	●	●	●	●	●	●	●	●	●	●
Extensions - Secretarial Return	●	●	●	●	●	●	●	●	●	●	●	●	●	●	●
Extensions - Meeting	●	●	●	●	●	●	●	●	●	●	●	●	●	●	●
Extensions - Linking	●	●	●	●	●	●	●	●	●	●	●	●	●	●	●
Meeting - Conference / Meeting	●	●	●	●	●	●	●	●	●	●	●	●	●	●	●

Callisto Fixed Height Workstations



A simplistic design provides the structure of Callisto, supporting an almost invisible wire management system. Cables can be routed from the base of the leg upright via an attractive and removable cable riser, to an optional horizontal cable tray, to carry high capacity wires under the desk top. The simple and well-engineered design of Callisto, ensures a swift and efficient installation.

Callisto Workstations

Lead Time: Standard (All products are manufactured to order and when 'Standard Lead Time' is quoted (7 – 10 days), this may vary dependant on volume ordered, factory capacity and distribution requirements at the time of ordering. For more information please contact your Dealer Business Manager or the Customer Services Team for clarification.)

Wood: Available in MFC (Ash, Autumn Cherry, Beech, Chester Oak, English Walnut, Grey, Grey Nebraska Oak, Laurentii Wenge, Natural Nebraska Oak and White)
Top Panel Edge Detail available on 25mm White MFC (Wenge and Black - Add £32 Retail Per Top) (Plywood - Add £42 Retail Per Top)
Available in Veneer (Oak and Walnut) on a 3 Week Lead Time

Metalwork: Available in Silver RAL 9006 (Standard), Black Graphite RAL 9004, White RAL 9003 and Chrome Effect (Add 15%)



CR16

Callisto Rectangular Desk

• 25mm top panel. • Horizontal cable clips and 2x vertical cable risers as standard.

	MFC	Veneer (3 Week Lead Time)
CR18 - 1800w x 800d x 740h	£588	£854
CR16 - 1600w x 800d x 740h	£567	£823
CR14 - 1400w x 800d x 740h	£550	£795
CR12 - 1200w x 800d x 740h	£534	£769
CR10 - 1000w x 800d x 740h	£513	£745
CR18/6 - 1800w x 600d x 740h	£567	£823
CR16/6 - 1600w x 600d x 740h	£554	£800
CR14/6 - 1400w x 600d x 740h	£537	£775
CR12/6 - 1200w x 600d x 740h	£524	£752
CR10/6 - 1000w x 600d x 740h	£504	£725



CRB16

Callisto Bow Fronted Rectangular Desk

• 25mm top panel. • Horizontal cable clips and 2x vertical cable risers as standard.

	MFC	Veneer (3 Week Lead Time)
CRB18 - 1800w x 900d x 740h	£818	£1,183
CRB16 - 1600w x 900d x 740h	£797	£1,150



CR20DRH

Callisto 'D' Ended Desk

• 25mm top panel. • Horizontal cable clips and 2x vertical cable risers as standard.

	MFC	Veneer (3 Week Lead Time)
CR22DLH - 2200w x 800d x 740h	£867	£1,255
CR22DRH - 2200w x 800d x 740h	£867	£1,255
CR20DLH - 2000w x 800d x 740h	£851	£1,233
CR20DRH - 2000w x 800d x 740h	£851	£1,233



CRE19RH

Callisto Radius Executive Desk

• 25mm top panel. • Horizontal cable clips and 2x vertical cable risers as standard.

	MFC	Veneer (3 Week Lead Time)
CRE19LH - 1900w x 1000d x 740h	£818	£1,183
CRE19RH - 1900w x 1000d x 740h	£818	£1,183



CC16RH

Callisto Crescent Workstation

• 25mm top panel. • Horizontal cable clips and 2x vertical cable risers as standard.
• 600mm return.

	MFC	Veneer (3 Week Lead Time)
CC18LH - 1800w x 1200d x 740h	£873	£1,268
CC18RH - 1800w x 1200d x 740h	£873	£1,268
CC16LH - 1600w x 1200d x 740h	£838	£1,215
CC16RH - 1600w x 1200d x 740h	£838	£1,215
CC14LH - 1400w x 1200d x 740h	£811	£1,171
CC14RH - 1400w x 1200d x 740h	£811	£1,171

Callisto Workstations

Lead Time: Standard (All products are manufactured to order and when 'Standard Lead Time' is quoted (7 – 10 days), this may vary dependant on volume ordered, factory capacity and distribution requirements at the time of ordering. For more information please contact your Dealer Business Manager or the Customer Services Team for clarification.)

Wood: Available in MFC (Ash, Autumn Cherry, Beech, Chester Oak, English Walnut, Grey, Grey Nebraska Oak, Laurentii Wenge, Natural Nebraska Oak and White)
Top Panel Edge Detail available on 25mm White MFC (Wenge and Black - Add £32 Retail Per Top) (Plywood - Add £42 Retail Per Top)
Available in Veneer (Oak and Walnut) on a 3 Week Lead Time

Metalwork: Available in Silver RAL 9006 (Standard), Black Graphite RAL 9004, White RAL 9003 and Chrome Effect (Add 15%)



CCB18RH

Callisto Bow Fronted Crescent Workstation

- 25mm top panel.
- Horizontal cable clips and 2x vertical cable risers as standard.
- 600mm return.

	MFC	Veneer (3 Week Lead Time)
CCB18LH - 1800w x 1300d x 740h	£1,101	£1,591
CCB18RH - 1800w x 1300d x 740h	£1,101	£1,591



CRC19RH

Callisto Radius Crescent Workstation

- 25mm top panel.
- Horizontal cable clips and 2x vertical cable risers as standard.
- 600mm return.

	MFC	Veneer (3 Week Lead Time)
CRC19LH - 1900w x 1200d x 740h	£1,101	£1,591
CRC19RH - 1900w x 1200d x 740h	£1,101	£1,591

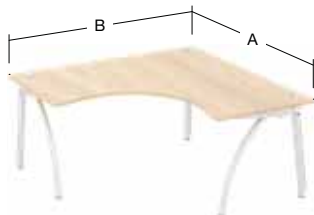

CSC16A

Callisto Symmetrical Crescent Workstation

- 25mm top panel.
- Horizontal cable clips and 2x vertical cable risers as standard.
- 2x 800mm ends.
- The grain direction is shown as 'A' and 'B'.

	MFC	Veneer (3 Week Lead Time)
CSC18A - 1800w x 1800d x 740h	£1,101	£1,591
CSC18B - 1800w x 1800d x 740h	£1,101	£1,591
CSC16A - 1600w x 1600d x 740h	£1,035	£1,496
CSC16B - 1600w x 1600d x 740h	£1,035	£1,496



CW16RH

Callisto Single Wave Desk

- 25mm top panel.
- Horizontal cable clips and 2x vertical cable risers as standard.

	MFC	Veneer (3 Week Lead Time)
CW18LH - 1800w x 1000-800d x 740h	£707	£1,023
CW18RH - 1800w x 1000-800d x 740h	£707	£1,023
CW16LH - 1600w x 1000-800d x 740h	£687	£987
CW16RH - 1600w x 1000-800d x 740h	£687	£987
CW14LH - 1400w x 1000-800d x 740h	£663	£957
CW14RH - 1400w x 1000-800d x 740h	£663	£957
CW12LH - 1200w x 1000-800d x 740h	£632	£915
CW12RH - 1200w x 1000-800d x 740h	£632	£915
CW18/6LH - 1800w x 800-600d x 740h	£674	£975
CW18/6RH - 1800w x 800-600d x 740h	£674	£975
CW16/6LH - 1600w x 800-600d x 740h	£653	£940
CW16/6RH - 1600w x 800-600d x 740h	£653	£940
CW14/6LH - 1400w x 800-600d x 740h	£631	£912
CW14/6RH - 1400w x 800-600d x 740h	£631	£912
CW12/6LH - 1200w x 800-600d x 740h	£602	£869
CW12/6RH - 1200w x 800-600d x 740h	£602	£869

Callisto Workstations

Lead Time: Standard (All products are manufactured to order and when 'Standard Lead Time' is quoted (7 – 10 days), this may vary dependant on volume ordered, factory capacity and distribution requirements at the time of ordering. For more information please contact your Dealer Business Manager or the Customer Services Team for clarification.)

Wood: Available in MFC (Ash, Autumn Cherry, Beech, Chester Oak, English Walnut, Grey, Grey Nebraska Oak, Laurentii Wenge, Natural Nebraska Oak and White)
Top Panel Edge Detail available on 25mm White MFC (Wenge and Black - Add £32 Retail Per Top) (Plywood - Add £42 Retail Per Top)
Available in Veneer (Oak and Walnut) on a 3 Week Lead Time

Metalwork: Available in Silver RAL 9006 (Standard), Black Graphite RAL 9004, White RAL 9003 and Chrome Effect (Add 15%)



CDW16/9

Callisto Double Wave Desk

- 25mm top panel.
- Horizontal cable clips and 2x vertical cable risers as standard.

	MFC	Veneer (3 Week Lead Time)
CDW18/10 - 900d Centre - 1800w x 1000d x 740h	£734	£1,048
CDW16/10 - 900d Centre - 1600w x 1000d x 740h	£708	£1,017
CDW18/9 - 800d Centre - 1800w x 900d x 740h	£729	£1,042
CDW16/9 - 800d Centre - 1600w x 900d x 740h	£703	£1,012



C120

Callisto 120 Degree Workstation

- 25mm top panel.
- Can be configured as a single workstation or in modules of 3, 6, 9, etc.
- Horizontal cable clips and 2x vertical cable risers as standard.

	MFC	Veneer (3 Week Lead Time)
C120 - 2078w (extreme) x 800d x 740h	£869	£1,256
C120/6 - 1732w (extreme) x 600d x 740h	£782	£1,124



CK20

Callisto Kidney Desk

- 25mm top panel.
- Horizontal cable clips and 2x vertical cable risers as standard.

	MFC	Veneer (3 Week Lead Time)
CK20 - 2000w (extreme) x 800d x 740h	£869	£1,256



CRR18

Callisto Radius Reception Desk

- 25mm top panel.
- Horizontal cable clips and 2x vertical cable risers as standard.

	MFC	Veneer (3 Week Lead Time)
CRR20 - 2000w (extreme) x 800d x 740h	£1,042	£1,621
CRR18 - 1800w (extreme) x 800d x 740h	£942	£1,465



CRDRH

Callisto Reception Desk

- 2x 25mm top panels.
- 850mm and 600mm ends are slightly curved.
- Horizontal cable clips and 2x vertical cable risers as standard.

	MFC	Veneer (3 Week Lead Time)
CRDLH - 1850w (extreme) x 1800d x 740h	£1,584	£2,289
CRDRH - 1850w (extreme) x 1800d x 740h	£1,584	£2,289

Callisto Workstations, Extensions and Accessories

Lead Time: Standard (All products are manufactured to order and when 'Standard Lead Time' is quoted (7 – 10 days), this may vary dependant on volume ordered, factory capacity and distribution requirements at the time of ordering. For more information please contact your Dealer Business Manager or the Customer Services Team for clarification.)

Wood: Available in MFC (Ash, Autumn Cherry, Beech, Chester Oak, English Walnut, Grey, Grey Nebraska Oak, Laurentii Wenge, Natural Nebraska Oak and White)
Top Panel Edge Detail available on 25mm White MFC (Wenge and Black - Add £32 Retail Per Top) (Plywood - Add £42 Retail Per Top)
Available in Veneer (Oak and Walnut) on a 3 Week Lead Time

Metalwork: Available in Silver RAL 9006 (Standard), Black Graphite RAL 9004, White RAL 9003 and Chrome Effect (Add 15%)



CSCMT16

Callisto Meeting Extension

- 25mm top panel.
- Complete with fixing beams.

		MFC	Veneer (3 Week Lead Time)
CSCMT16	- For 1600d Ends - 1600w x 660d x 740h	£632	£915
CSCMT12	- For 1200d Ends - 1200w x 600d x 740h	£607	£881
CSCMT8	- For 800d Ends - 800w x 600d x 740h	£406	£583
CSCMT120	- For C120 - 1600w x 660d x 740h	£632	£915



CMP16
Illustrated in red

Callisto Steel Modesty Panel

- Modesty panels are 400mm high.

			Metalwork
CMP18	- For 1800w Workstations - 1400w		£180
CMP16	- For 1600w Workstations - 1200w		£175
CMP14	- For 1400w Workstations - 1000w		£171
CMP12	- For 1200w Workstations - 800w		£170
CMP10	- For 1000w Workstations - 600w		£163
CRMP20	- For CRR20 - Curved		£223
CRMP18	- For CRR18 - Curved		£213
CKMP	- For CK20 - Curved		£219



CWMT16
Illustrated in red

Callisto Cable Tray

- High capacity cable tray to conceal power, data and telecom cables through a hinged tray.
- Cable trays are 130mm deep and 75mm high.
- For compatible desks, see page 133.

			Metalwork
CWMT18	- For 1800w Workstations - 1300w		£129
CWMT16	- For 1600w Workstations - 1100w		£114
CWMT14	- For 1400w Workstations - 900w		£96
CWMT12	- For 1200w Workstations - 700w		£82
CWMT10	- For 1000w Workstations - 500w		£67

Callisto Accessories

Lead Time: Standard (All products are manufactured to order and when 'Standard Lead Time' is quoted (7 – 10 days), this may vary dependant on volume ordered, factory capacity and distribution requirements at the time of ordering. For more information please contact your Dealer Business Manager or the Customer Services Team for clarification.)



F2LMPBT

Showing Bolt Through Version

Flex Monitor Arm

- Post mounted monitor arm with 2x folding links.

	Price
F2LMP - Silver Clamp on Desk Fixing	£180
F2LMP/W - White Clamp on Desk Fixing	£180
• Manual Post Height Adjustment	
F2LGP - Silver Clamp on Desk Fixing	£227
F2LGP/W - White Clamp on Desk Fixing	£227
• Front End Height Adjustment	

Callisto Cable Tray Compatibility

	Callisto Cable Tray
Rectangular - CR18 (+/6) (+HA)	CWNMT18 - 1300W
Rectangular - CR16 (+/6) (+HA)	CWNMT16 - 1100W
Rectangular - CR14 (+/6) (+HA)	CWNMT14 - 900W
Rectangular - CR12 (+/6) (+HA)	CWNMT12 - 700W
Rectangular - CR10 (+/6) (+HA)	CWNMT10 - 500W
Bow Fronted Rectangular - CRB18	CWNMT18 - 1300W
Bow Fronted Rectangular - CRB16	CWNMT16 - 1100W
'D' Ended - CR22D (LH/RH)	CWNMT18 - 1300W
'D' Ended - CR20D (LH/RH)	CWNMT16 - 1100W
Radius Executive - CRE19 (LH/RH)	CWNMT16 - 1100W
Crescent - CC18 (LH/RH)	CWNMT18 - 1300W
Crescent - CC16 (LH/RH)	CWNMT16 - 1100W
Crescent - CC14 (LH/RH)	CWNMT14 - 900W
Bow Fronted Crescent - CCB18 (LH/RH)	CWNMT18 - 1300W
Radius Crescent - CRC19 (LH/RH)	CWNMT16 - 1100W
Symmetrical Crescent - CSC18 (A/B)	CWNMT18 - 1300W
Symmetrical Crescent - CSC16 (A/B)	CWNMT16 - 1100W
Single Wave - CW18 (LH/RH) (+/6)	CWNMT18 - 1300W
Single Wave - CW16 (LH/RH) (+/6)	CWNMT16 - 1100W
Single Wave - CW14 (LH/RH) (+/6)	CWNMT14 - 900W
Single Wave - CW12 (LH/RH) (+/6)	CWNMT12 - 700W
Double Wave - CDW18 (+/10) (+/9)	CWNMT18 - 1300W
Double Wave - CDW16 (+/10) (+/9)	CWNMT16 - 1100W
120 Degree - C120	CWNMT12 - 700W
120 Degree - C120/6	CWNMT10 - 500W
Kidney - CK20	CWNMT16 - 1100W
Radius Reception - CRR20	CWNMT14 - 900W
Radius Reception - CRR18	CWNMT12 - 700W
Reception - CRD (LH/RH)	CWNMT10 - 500W

Callisto Conference / Meeting Tables

Lead Time: Standard (All products are manufactured to order and when 'Standard Lead Time' is quoted (7 – 10 days), this may vary dependant on volume ordered, factory capacity and distribution requirements at the time of ordering. For more information please contact your Dealer Business Manager or the Customer Services Team for clarification.)

Wood: Available in MFC (Ash, Autumn Cherry, Beech, Chester Oak, English Walnut, Grey, Grey Nebraska Oak, Laurentii Wenge, Natural Nebraska Oak and White)
Top Panel Edge Detail available on 25mm White MFC (Wenge and Black - Add £32 Retail Per Top) (Plywood - Add £42 Retail Per Top)
Available in Veneer (Oak and Walnut) on a 3 Week Lead Time

Metalwork: Available in Silver RAL 9006 (Standard), Black Graphite RAL 9004, White RAL 9003 and Chrome Effect (Add 15%)
Also available in Blue RAL 5001, Coral RAL 2001, Green RAL 6016, Light Grey RAL 7038, Teal RAL 5018 and Yellow RAL 1021 (Add 12% for all - 2 Week Lead Time)



CSCT

Callisto Segué Conference Table

• 25mm top panel. • 'A' frame style leg configuration. • Optional infill panel.

CSCT - 4830w (extreme) x 2470d (extreme) x 740h _____

• 6x Curved Sections and 2x Curved Corner Sections • Seating up to 16 People

CSCTI - Infill Panel Only _____

	MFC	Veneer (3 Week Lead Time)
CSCT	£3,927	£5,679
CSCTI	£629	£907



CSMT

Callisto Segué Meeting Table

• 25mm top panel. • 'A' frame style leg configuration. • Optional infill panel.

CSMT - 2830w (extreme) x 2755d (extreme) x 740h _____

• 3x Curved Sections and 3x Curved Corner Sections • Seating up to 12 People

CSMTI - Infill Panel Only _____

	MFC	Veneer (3 Week Lead Time)
CSMT	£3,517	£5,091
CSMTI	£514	£749



COCT24

Callisto Oval Conference Table

• 25mm top panel. • 'A' frame style leg configuration.

COCT24 - 2400w x 1200d x 740h _____

• 1x 2400mm Section • Seating up to 8 People

	MFC	Veneer (3 Week Lead Time)
COCT24	£1,466	£2,124



Callisto Accessory Compatibility

- **BLACK** - Compatible
- **BLUE** - Conflict when using screens

	Screens	Power and Data Modules							Monitor Arms						
	Desk Mounted Screens, page 272-289	Kaspa and Prime, page 309	Boardroom, Conus and Peak, page 310-312	Escalate, page 312	Wireless Charging Unit, page 313	Port Hole and Pix, page 314	Pluto and Inca, page 315	Flex and Capsule, page 316-317	Plaza and Boost, page 318	Wieland Socket Boxes, page 319	M2, page 320	Flex, page 320-322	Ascend, page 321-322	Ollin and Flo, page 321-322	M8, page 322
Workstations - Height Adjustable Rectangular	●	●	●	●	●	●	●	●	●	●	●	●	●	●	●
Workstations - Height Adjustable Bow Fronted Rectangular	●	●	●	●	●	●	●	●	●	●	●	●	●	●	●
Workstations - Height Adjustable D Ended	●	●	●	●	●	●	●	●	●	●	●	●	●	●	●
Workstations - Height Adjustable Crescent	●	●	●	●	●	●	●	●	●	●	●	●	●	●	●
Workstations - Height Adjustable Bow Fronted Crescent	●	●	●	●	●	●	●	●	●	●	●	●	●	●	●
Workstations - Height Adjustable Single Wave	●	●	●	●	●	●	●	●	●	●	●	●	●	●	●
Workstations - Height Adjustable 120 Degree	●	●	●	●	●	●	●	●	●	●	●	●	●	●	●
Workstations - Rectangular	●	●	●	●	●	●	●	●	●	●	●	●	●	●	●
Workstations - Bow Fronted Rectangular	●	●	●	●	●	●	●	●	●	●	●	●	●	●	●
Workstations - D Ended	●	●	●	●	●	●	●	●	●	●	●	●	●	●	●
Workstations - Radius Executive	●	●	●	●	●	●	●	●	●	●	●	●	●	●	●
Workstations - Crescent	●	●	●	●	●	●	●	●	●	●	●	●	●	●	●
Workstations - Bow Fronted Crescent	●	●	●	●	●	●	●	●	●	●	●	●	●	●	●
Workstations - Radius Crescent	●	●	●	●	●	●	●	●	●	●	●	●	●	●	●
Workstations - Symmetrical Crescent	●	●	●	●	●	●	●	●	●	●	●	●	●	●	●
Workstations - Single Wave	●	●	●	●	●	●	●	●	●	●	●	●	●	●	●
Workstations - Double Wave	●	●	●	●	●	●	●	●	●	●	●	●	●	●	●
Workstations - 120 Degree	●	●	●	●	●	●	●	●	●	●	●	●	●	●	●
Workstations - Kidney	●	●	●	●	●	●	●	●	●	●	●	●	●	●	●
Workstations - Radius Reception	●	●	●	●	●	●	●	●	●	●	●	●	●	●	●
Workstations - Reception	●	●	●	●	●	●	●	●	●	●	●	●	●	●	●
Extensions - Meeting			●		●		●								
Meeting - Conference / Meeting		●	●	●	●	●	●	●	●	●					

Windsor Fixed Height Workstations



Windsor features panel ended workstations, delivering a distinct and executive finish. The traditional appearance offers a clean, premium feel within the set environment. Windsor offers a vast number of configurations and footprints meeting the demands of a flexible workspace. These include single desks, managerial workstations, reception units and meeting and conference tables.

Windsor Workstations

Lead Time: Standard (All products are manufactured to order and when 'Standard Lead Time' is quoted (7 – 10 days), this may vary dependant on volume ordered, factory capacity and distribution requirements at the time of ordering. For more information please contact your Dealer Business Manager or the Customer Services Team for clarification.)

Wood: Available in MFC (Ash, Autumn Cherry, Beech, Chester Oak, English Walnut, Grey, Grey Nebraska Oak, Laurentii Wenge, Natural Nebraska Oak and White)
Top Panel Edge Detail available on 25mm White MFC (Wenge and Black - Add £32 Retail Per Top) (Plywood - Add £42 Retail Per Top)
Available in Veneer (Oak and Walnut) on a 3 Week Lead Time

Metalwork: Available in Silver RAL 9006 (Standard) Only



WR16

Windsor Rectangular Desk

• 25mm top panel.

	MFC	Veneer (3 Week Lead Time)
WR18 - 1800w x 800d x 740h	£509	£789
WR16 - 1600w x 800d x 740h	£491	£763
WR14 - 1400w x 800d x 740h	£470	£732
WR12 - 1200w x 800d x 740h	£453	£707
WR10 - 1000w x 800d x 740h	£436	£683



WRB18

Windsor Bow Fronted Rectangular Desk

• 25mm top panel.

	MFC	Veneer (3 Week Lead Time)
WRB18 - 1800w x 900d x 740h	£729	£1,127
WRB16 - 1600w x 900d x 740h	£707	£1,099



WC16RH

Windsor Crescent Workstation

• 25mm top panel. • 600mm return.

	MFC	Veneer (3 Week Lead Time)
WC18LH - 1800w x 1200d x 740h	£686	£1,061
WC18RH - 1800w x 1200d x 740h	£686	£1,061
WC16LH - 1600w x 1200d x 740h	£650	£1,006
WC16RH - 1600w x 1200d x 740h	£650	£1,006
WC14LH - 1400w x 1200d x 740h	£620	£954
WC14RH - 1400w x 1200d x 740h	£620	£954



WCB18RH

Windsor Bow Fronted Crescent Workstation

• 25mm top panel. • 600mm return.

	MFC	Veneer (3 Week Lead Time)
WCB18LH - 1800w x 1300d x 740h	£800	£1,241
WCB18RH - 1800w x 1300d x 740h	£800	£1,241



WW16RH

Windsor Single Wave Desk

• 25mm top panel.

	MFC	Veneer (3 Week Lead Time)
WW18LH - 1800w x 1000-800d x 740h	£629	£975
WW18RH - 1800w x 1000-800d x 740h	£629	£975
WW16LH - 1600w x 1000-800d x 740h	£605	£940
WW16RH - 1600w x 1000-800d x 740h	£605	£940
WW14LH - 1400w x 1000-800d x 740h	£587	£911
WW14RH - 1400w x 1000-800d x 740h	£587	£911
WW12LH - 1200w x 1000-800d x 740h	£564	£872
WW12RH - 1200w x 1000-800d x 740h	£564	£872

Windsor Workstations

Lead Time: Standard (All products are manufactured to order and when 'Standard Lead Time' is quoted (7 – 10 days), this may vary dependant on volume ordered, factory capacity and distribution requirements at the time of ordering. For more information please contact your Dealer Business Manager or the Customer Services Team for clarification.)

Wood: Available in MFC (Ash, Autumn Cherry, Beech, Chester Oak, English Walnut, Grey, Grey Nebraska Oak, Laurentii Wenge, Natural Nebraska Oak and White)
Top Panel Edge Detail available on 25mm White MFC (Wenge and Black - Add £32 Retail Per Top) (Plywood - Add £42 Retail Per Top)
Available in Veneer (Oak and Walnut) on a 3 Week Lead Time

Metalwork: Available in Silver RAL 9006 (Standard), Black Graphite RAL 9004 and White RAL 9003



WDW16/9

Windsor Double Wave Desk

- 25mm top panel.

	MFC	Veneer (3 Week Lead Time)
WDW18/10 - 900d Centre - 1800w x 1000d x 740h	£689	£1,034
WDW16/10 - 900d Centre - 1600w x 1000d x 740h	£667	£1,001
WDW18/9 - 800d Centre - 1800w x 900d x 740h	£648	£992
WDW16/9 - 800d Centre - 1600w x 900d x 740h	£629	£960



WSR10/6RH

Windsor Secretarial Return

- 25mm top panel. • Compatible with rectangular desks and crescent workstations only.

	MFC	Veneer (3 Week Lead Time)
WSR10/6LH - 1000w x 600d x 740h	£340	£526
WSR10/6RH - 1000w x 600d x 740h	£340	£526



WSCMT16

Windsor Meeting Extension

- 25mm top panel. • Complete with 120mm diameter support leg on 300mm diameter base.

	MFC	Veneer (3 Week Lead Time)
WSCMT16 - For 1600d Ends - 1600w x 660d x 740h	£712	£1,034
WSCMT12 - For 1200d Ends - 1200w x 600d x 740h	£688	£991
WSCMT8 - For 800d Ends - 800w x 600d x 740h	£639	£929
WDWSCMT18 - For 900d Double Wave Desks - 1800w x 800d x 740h	£828	£1,209



DWSCMT

Windsor Meeting Extension

- 25mm top panel. • Complete with 2x 60mm diameter support legs.

	MFC	Veneer (3 Week Lead Time)
DWSCMT - For 1000d Double Wave Desks - 2000w x 800d x 740h	£844	£1,224



WRU18RH

Windsor Bow Fronted Reception Workstation

- 25mm top panel. • 600mm return. • Desktop is 745mm high.

	MFC	Veneer (3 Week Lead Time)
WRU20LH - 2000w x 1350d x 1100h	£2,047	£3,172
WRU20RH - 2000w x 1350d x 1100h	£2,047	£3,172
WRU18LH - 1800w x 1350d x 1100h	£1,962	£3,042
WRU18RH - 1800w x 1350d x 1100h	£1,962	£3,042

Windsor Reception and Accessories

Lead Time: Standard (All products are manufactured to order and when 'Standard Lead Time' is quoted (7 – 10 days), this may vary dependant on volume ordered, factory capacity and distribution requirements at the time of ordering. For more information please contact your Dealer Business Manager or the Customer Services Team for clarification.)

Wood: Available in MFC (Ash, Autumn Cherry, Beech, Chester Oak, English Walnut, Grey, Grey Nebraska Oak, Laurentii Wenge, Natural Nebraska Oak and White)
Top Panel Edge Detail available on 25mm White MFC (Wenge and Black - Add £32 Retail Per Top) (Plywood - Add £42 Retail Per Top)
Available in Veneer (Oak and Walnut) on a 3 Week Lead Time

Metalwork: Available in Silver RAL 9006 (Standard), Black Graphite RAL 9004 and White RAL 9003



RRRH

Windsor Radius Reception Desk with DDA Extension

- 25mm top panel. • Designed for wheelchair visitor access.
- Complete with kick plate (stainless steel only).
- Delivered assembled. • Desktop is 745mm high.

RRLH - 2800w (extreme) x 800d x 745h _____

RRRH - 2800w (extreme) x 800d x 745h _____

MFC

**Veneer
(3 Week
Lead Time)**

£2,537

£2,537

£3,933

£3,933



RR

Windsor Radius Reception Desk

- 25mm top panel. • Complete with kick plate (stainless steel only).
- Delivered assembled. • Desktop is 745mm high.

RR - 1915w (extreme) x 800d x 745h _____

MFC

**Veneer
(3 Week
Lead Time)**

£2,214

£3,438



DCT

Windsor Curved Double Counter Top

- 25mm top panel. • Windsor curved double counter top does not sit flush either end of Windsor radius reception desks due to its fixings.

DCT - 1800w (extreme) x 240d x 380h _____

MFC

**Veneer
(3 Week
Lead Time)**

£1,971

£3,053



SCT

Windsor Curved Single Counter Top

- 25mm top panel. • Windsor curved single counter top can be positioned left, centre or right of the reception desk.

SCT - 980w x 240d x 380h _____

MFC

**Veneer
(3 Week
Lead Time)**

£1,044

£1,618



F2LMPBT

Flex Monitor Arm

- Post mounted monitor arm with 2x folding links.

F2LMP - Silver Clamp on Desk Fixing _____

F2LMP/W - White Clamp on Desk Fixing _____

- Manual Post Height Adjustment

F2LGP - Silver Clamp on Desk Fixing _____

F2LGP/W - White Clamp on Desk Fixing _____

- Front End Height Adjustment

Price

£180

£180

£227

£227

Windsor Accessories and Conference / Meeting Tables

Lead Time: Standard (All products are manufactured to order and when 'Standard Lead Time' is quoted (7 – 10 days), this may vary dependant on volume ordered, factory capacity and distribution requirements at the time of ordering. For more information please contact your Dealer Business Manager or the Customer Services Team for clarification.)

Wood: Available in MFC (Ash, Autumn Cherry, Beech, Chester Oak, English Walnut, Grey, Grey Nebraska Oak, Laurentii Wenge, Natural Nebraska Oak and White)
 Top Panel Edge Detail available on 25mm White MFC (Wenge and Black - Add £32 Retail Per Top) (Plywood - Add £42 Retail Per Top)
 Available in Veneer (Oak and Walnut) on a 3 Week Lead Time

Metalwork: Available in Silver RAL 9006 (Standard), Black Graphite RAL 9004 and White RAL 9003



OF9
Illustrated in red

Windsor Cable Tray

- Cable trays are 100mm deep and 110mm high.
- For compatible desks, see below.

Model	Width	Metalwork Price
OF11	1475w	£76
OF10	1385w	£73
OF9	1275w	£70
OF8	1185w	£64
OF7	1075w	£61
OF6	970w	£59
OF5	900w	£58
OF4	860w	£57
OF3	755w	£55
OF2	670w	£54
OF1	500w	£49

Windsor Cable Tray Compatibility

- Rectangular - WR18
- Rectangular - WR16
- Rectangular - WR14
- Rectangular - WR12
- Rectangular - WR10
- Bow Fronted Rectangular - WRB18
- Bow Fronted Rectangular - WRB16
- Crescent - WC18 (LH/RH)
- Crescent - WC16 (LH/RH)
- Crescent - WC14 (LH/RH)
- Bow Fronted Crescent - WCB18 (LH/RH)
- Single Wave - WW18 (LH/RH)
- Single Wave - WW16 (LH/RH)
- Single Wave - WW14 (LH/RH)
- Single Wave - WW12 (LH/RH)
- Double Wave - WDW18 (+/10) (+/9)
- Double Wave - WDW16 (+/10) (+/9)
- Secretarial Return - WSR (LH/RH)
- Bow Fronted Reception - WRU20 (LH/RH)
- Bow Fronted Reception - WRU18 (LH/RH)

Windsor Cable Tray

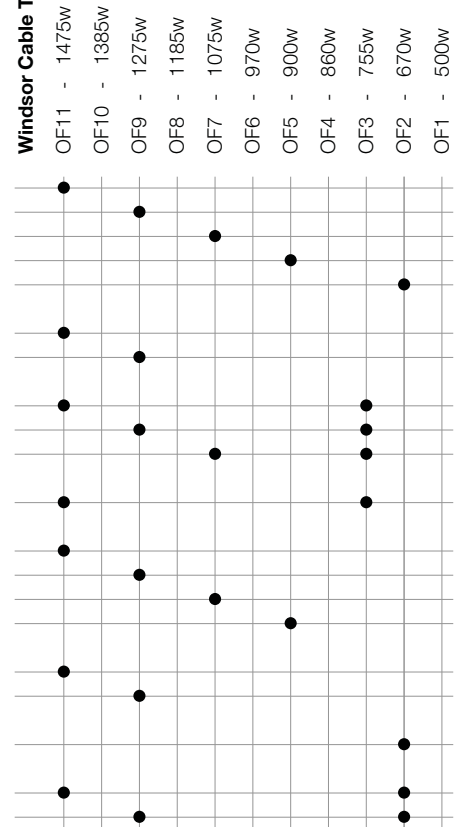

CONF2AL

Windsor Double 'D' Ended Conference Table

- 25mm top panel. • Arrowhead leg configuration with modesty panel.

Model	Dimensions	MFC Price	Veneer (3 Week Lead Time) Price
CONF2AL	3400w x 1200d x 740h • 2x 1700mm Sections • Seating up to 10 People	£2,180	£3,384
DDT24	2400w x 1200d x 740h • 1x 2400mm Section • Seating up to 8 People	£1,531	£2,372



DDT24

Windsor Conference / Meeting Tables

Lead Time: Standard (All products are manufactured to order and when 'Standard Lead Time' is quoted (7 – 10 days), this may vary dependant on volume ordered, factory capacity and distribution requirements at the time of ordering. For more information please contact your Dealer Business Manager or the Customer Services Team for clarification.)
Wood: Available in MFC (Ash, Autumn Cherry, Beech, Chester Oak, English Walnut, Grey, Grey Nebraska Oak, Laurentii Wenge, Natural Nebraska Oak and White)
 Top Panel Edge Detail available on 25mm White MFC (Wenge and Black - Add £32 Retail Per Top) (Plywood - Add £42 Retail Per Top)
 Available in Veneer (Oak and Walnut) on a 3 Week Lead Time
Metalwork: Available in Silver RAL 9006 (Standard), Black Graphite RAL 9004 and White RAL 9003



OVT24

Windsor Oval Conference Table

• 25mm top panel. • Arrowhead leg configuration with modesty panel.

OVT24 - 2400w x 1200d x 740h
 • 1x 2400mm Section • Seating up to 8 People

MFC | £1,531
Veneer (3 Week Lead Time) | £2,372



BST24

Windsor Barrel Conference Table

• 25mm top panel. • Arrowhead leg configuration with modesty panel.

BST24 - 2400w x 1200d x 740h
 • 1x 2400mm Section • Seating up to 8 People

MFC | £1,531
Veneer (3 Week Lead Time) | £2,372

Windsor Accessory Compatibility

- **BLACK** - Compatible
- **ORANGE** - Non-standard position required
- **BLUE** - Conflict when using screens

- Workstations** - Rectangular
- Workstations** - Bow Fronted Rectangular
- Workstations** - Crescent
- Workstations** - Bow Fronted Crescent
- Workstations** - Single Wave
- Workstations** - Double Wave
- Workstations** - Bow Fronted Reception
- Workstations** - Radius Reception
- Workstations** - Radius Reception with Counter Tops
- Extensions** - Secretarial Return
- Extensions** - Meeting
- Meeting** - Conference / Meeting

	Screens	Power and Data Modules	Monitor Arms
	Desk Mounted Screens, page 272-289	Kaspa and Prime, page 309 Boardroom, Conus and Peak, page 310-312 Escalate, page 312 Wireless Charging Unit, page 313 Port Hole and Pix, page 314 Pluto and Inca, page 315 Flex and Capsule, page 316-317 Plaza and Boost, page 318 Wieland Socket Boxes, page 319	M2, page 320 Flex, page 320-322 Ascend, page 321-322 Ollin and Flo, page 321-322 M8, page 322
Workstations - Rectangular	●	●	●
Workstations - Bow Fronted Rectangular		●	●
Workstations - Crescent	●	●	●
Workstations - Bow Fronted Crescent		●	●
Workstations - Single Wave	●	●	●
Workstations - Double Wave	●	●	●
Workstations - Bow Fronted Reception		●	●
Workstations - Radius Reception		●	●
Workstations - Radius Reception with Counter Tops		●	●
Extensions - Secretarial Return		●	●
Extensions - Meeting			
Meeting - Conference / Meeting		●	

Flexi Fixed Height Workstations



The Flexi range offers a slimline frame with a double upright cantilever leg. The range has been designed and engineered to offer a robust and durable solution. The leg frames are supported by an MFC modesty panel, integral to the structural integrity of the range. Vertical leg risers are compatible with the range to accommodate cables from the floor to the underside of the work surface. An optional horizontal cable tray can be positioned to the inside or outside of the modesty panel. This tray caters for cables under the work surface and access to the desktop via cable ports.

Flexi Workstations

Lead Time: Standard (All products are manufactured to order and when 'Standard Lead Time' is quoted (7 – 10 days), this may vary dependant on volume ordered, factory capacity and distribution requirements at the time of ordering. For more information please contact your Dealer Business Manager or the Customer Services Team for clarification.)

Wood: Available in MFC (Ash, Autumn Cherry, Beech, Chester Oak, English Walnut, Grey, Grey Nebraska Oak, Laurentii Wenge, Natural Nebraska Oak and White)
Top Panel Edge Detail available on 25mm White MFC (Wenge and Black - Add £32 Retail Per Top) (Plywood - Add £42 Retail Per Top)

Metalwork: Available in Silver RAL 9006 (Standard), Black Graphite RAL 9004 and White RAL 9003



FR16

Flexi Rectangular Desk

- 25mm top panel.

		MFC
FR18	- 1800w x 800d x 740h	£465
FR16	- 1600w x 800d x 740h	£445
FR14	- 1400w x 800d x 740h	£423
FR12	- 1200w x 800d x 740h	£400
FR10	- 1000w x 800d x 740h	£378
FR8	- 800w x 800d x 740h	£357
FR18/6	- 1800w x 600d x 740h	£451
FR16/6	- 1600w x 600d x 740h	£431
FR14/6	- 1400w x 600d x 740h	£408
FR12/6	- 1200w x 600d x 740h	£388
FR10/6	- 1000w x 600d x 740h	£368
FR8/6	- 800w x 600d x 740h	£348



FC16RH

Flexi Crescent Workstation

- 25mm top panel. • 600mm return.

		MFC
FC18LH	- 1800w x 1200d x 740h	£615
FC18RH	- 1800w x 1200d x 740h	£615
FC16LH	- 1600w x 1200d x 740h	£593
FC16RH	- 1600w x 1200d x 740h	£593
FC14LH	- 1400w x 1200d x 740h	£568
FC14RH	- 1400w x 1200d x 740h	£568

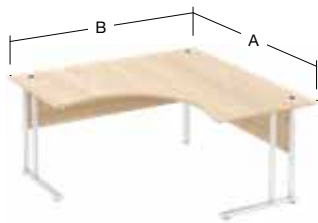

FSC16A

Flexi Symmetrical Crescent Workstation

- 25mm top panel. • 2x 800mm ends. • The grain direction is shown as 'A' and 'B'.

		MFC
FSC18A	- 1800w x 1800d x 740h	£898
FSC18B	- 1800w x 1800d x 740h	£898
FSC16A	- 1600w x 1600d x 740h	£843
FSC16B	- 1600w x 1600d x 740h	£843



FW16RH

Flexi Single Wave Desk

- 25mm top panel.

		MFC
FW18LH	- 1800w x 1000-800d x 740h	£550
FW18RH	- 1800w x 1000-800d x 740h	£550
FW16LH	- 1600w x 1000-800d x 740h	£527
FW16RH	- 1600w x 1000-800d x 740h	£527
FW14LH	- 1400w x 1000-800d x 740h	£508
FW14RH	- 1400w x 1000-800d x 740h	£508
FW12LH	- 1200w x 1000-800d x 740h	£484
FW12RH	- 1200w x 1000-800d x 740h	£484
FW18/6LH	- 1800w x 800-600d x 740h	£525
FW18/6RH	- 1800w x 800-600d x 740h	£525
FW16/6LH	- 1600w x 800-600d x 740h	£504
FW16/6RH	- 1600w x 800-600d x 740h	£504
FW14/6LH	- 1400w x 800-600d x 740h	£483
FW14/6RH	- 1400w x 800-600d x 740h	£483
FW12/6LH	- 1200w x 800-600d x 740h	£463
FW12/6RH	- 1200w x 800-600d x 740h	£463



FDW16/9

Flexi Double Wave Desk

- 25mm top panel.

		MFC
FDW18/9	- 800d Centre - 1800w x 900d x 740h	£568
FDW16/9	- 800d Centre - 1600w x 900d x 740h	£550

Flexi Workstations, Returns and Pedestals

Lead Time: Standard (All products are manufactured to order and when 'Standard Lead Time' is quoted (7 – 10 days), this may vary dependant on volume ordered, factory capacity and distribution requirements at the time of ordering. For more information please contact your Dealer Business Manager or the Customer Services Team for clarification.)

Wood: Available in MFC (Ash, Autumn Cherry, Beech, Chester Oak, English Walnut, Grey, Grey Nebraska Oak, Laurentii Wenge, Natural Nebraska Oak and White)
Top Panel Edge Detail available on 25mm White MFC (Wenge and Black - Add £32 Retail Per Top) (Plywood - Add £42 Retail Per Top)

Metalwork: Available in Silver RAL 9006 (Standard), Black Graphite RAL 9004 and White RAL 9003



F120

Flexi 120 Degree Workstation

- 25mm top panel.
- Can be a single workstation or configured as a 3, 6, 9, etc, person module.

MFC

F120 - 2078w (extreme) x 800d x 740h _____ | £657

F120/6 - 1732w (extreme) x 600d x 740h _____ | £623



FLW8/6

Flexi Linking Workstation

- 25mm top panel.
- Links 800mm and 600mm deep desks.

MFC

FLW8/6 - 1225w x 1225d x 740h _____ | £657

FLW8/4 - 1083w x 1083d x 740h _____ | £633

FLW6 - 1025w x 1025d x 740h _____ | £622



FSR10/6RH

Flexi Secretarial Return for Rectangular Desks

- 25mm top panel.
- Compatible with rectangular desks only.

MFC

FSR10/6LH - 1000w x 600d x 740h _____ | £314

FSR10/6RH - 1000w x 600d x 740h _____ | £314



FFPF

2 Drawer Fixed Under Desk Pedestal

- 25mm top panel.
- Lockable, includes 2x keys.
- Alternative handles available (see page 234-235).
- Compatible with 800mm deep Flexi rectangular desking only.

MFC

FFPF - 418w x 600d x 430h _____ | £251

- 1x Single and 1x Filing Drawer



FFP3

3 Drawer Fixed Under Desk Pedestal

- 25mm top panel.
- Lockable, includes 2x keys.
- Alternative handles available (see page 234-235).
- Compatible with 800mm deep Flexi rectangular desking only.

MFC

FFP3 - 418w x 600d x 430h _____ | £251

- 3x Single Drawers

Flexi Accessories

Lead Time: Standard (All products are manufactured to order and when 'Standard Lead Time' is quoted (7 – 10 days), this may vary dependant on volume ordered, factory capacity and distribution requirements at the time of ordering. For more information please contact your Dealer Business Manager or the Customer Services Team for clarification.)

Metalwork: Available in Silver RAL 9006 (Standard), Black Graphite and White RAL 9003



FLCR
Illustrated in red

Flexi Cable Risers

- Can be retrofitted.
- Single channel cable riser.
- Sold in pairs.

Metalwork

FLCR

£46



OF9
Illustrated in red

Flexi Cable Tray

- Cable trays are 100mm deep and 110mm high.
- For compatible desks, see below.

Metalwork

OF11	-	1475w	£76
OF10	-	1385w	£73
OF9	-	1275w	£70
OF8	-	1185w	£64
OF7	-	1075w	£61
OF6	-	970w	£59
OF5	-	900w	£58
OF4	-	860w	£57
OF3	-	755w	£55
OF2	-	670w	£54
OF1	-	500w	£49

Flexi Cable Tray Compatibility

Rectangular	-	FR18 (+/6)	
Rectangular	-	FR16 (+/6)	
Rectangular	-	FR14 (+/6)	
Rectangular	-	FR12 (+/6)	
Rectangular	-	FR10 (+/6)	
Rectangular	-	FR8 (+/6)	
Crescent	-	FC18 (LH/RH)	
Crescent	-	FC16 (LH/RH)	
Crescent	-	FC14 (LH/RH)	
Symmetrical Crescent	-	FSC18 (A/B)	
Symmetrical Crescent	-	FSC16 (A/B)	
Single Wave	-	FW18 (LH/RH) (+/6)	
Single Wave	-	FW16 (LH/RH) (+/6)	
Single Wave	-	FW14 (LH/RH) (+/6)	
Single Wave	-	FW12 (LH/RH) (+/6)	
Double Wave	-	FDW18/9	
Double Wave	-	FDW16/9	
120 Degree	-	F120	
120 Degree	-	F120/6	
Linking	-	FLW8/6 (+/4)	
Linking	-	FLW6	
Secretarial Return	-	WSR (LH/RH)	

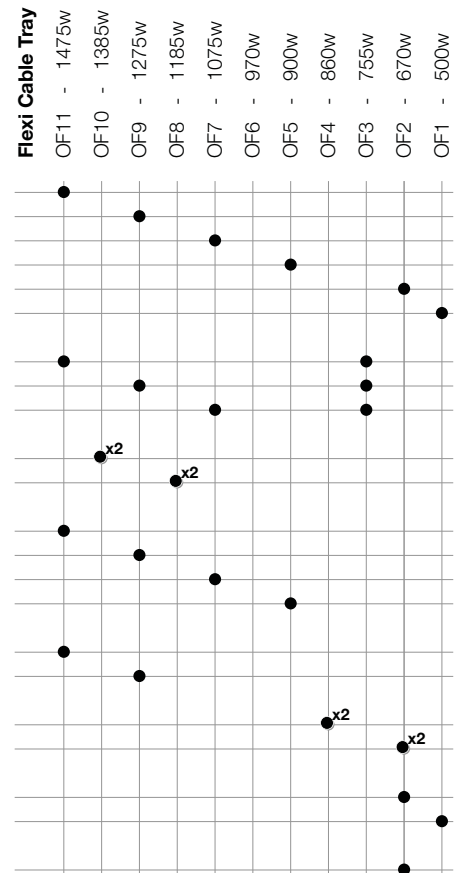

Flexi Accessories

Lead Time: Standard (All products are manufactured to order and when 'Standard Lead Time' is quoted (7 – 10 days), this may vary dependant on volume ordered, factory capacity and distribution requirements at the time of ordering. For more information please contact your Dealer Business Manager or the Customer Services Team for clarification.)



FCC
Illustrated in red

Flexi Cable Clip

- Three channel cable clip allows Flexi desking to comply with BS6396 electrical standards.
- Easy clip-on mount. • Grey plastic finish.

FCC

Price

£18



F2LMPBT
Showing Bolt Through Version

Flex Monitor Arm

- Post mounted monitor arm with 2x folding links.

F2LMP - Silver Clamp on Desk Fixing

F2LMP/W - White Clamp on Desk Fixing

- Manual Post Height Adjustment

F2LGP - Silver Clamp on Desk Fixing

F2LGP/W - White Clamp on Desk Fixing

- Front End Height Adjustment

Price

£180

£180

£227

£227

Flexi Accessory Compatibility

- **BLACK** - Compatible
- **BLUE** - Conflict when using screens
- **GREEN** - Unspecified

	Screens Desk Mounted Screens, page 272-289	Power and Data Modules Kaspa and Prime, page 309 Boardroom, Conus and Peak, page 310-312 Escalate, page 312 Wireless Charging Unit, page 313 Port Hole and Pix, page 314 Pluto and Inca, page 315 Flex and Capsule, page 316-317 Plaza and Boost, page 318 Wieland Socket Boxes, page 319	Monitor Arms M2, page 320 Flex, page 320-322 Ascend, page 321-322 Ollin and Flo, page 321-322 M8, page 322
Workstations - Rectangular	●	●	●
Workstations - Crescent	●	●	●
Workstations - Symmetrical Crescent	●	●	●
Workstations - Single Wave	●	●	●
Workstations - Double Wave	●	●	●
Workstations - 120 Degree	●	●	●
Extensions - Secretarial Return	●	●	●
Extensions - Linking	●	●	●

Modular Meeting Ends



Collaboration and agile working environments are an important aspect of the modern workspace, where flexible ways of working drive business requirements. Elite's modular table portfolio provides flexible solutions, ranging from high-level benches to modular flip-top tables for transient meeting spaces. An extensive range of high and mid-level benches allow for informal meeting and breakout areas while maintaining a professional appearance. A wide range of coffee tables, varying in style, has been designed to compliment Elite's breakout seating creating a more cohesive environment.

Modular Meeting Ends Desktop Meeting Ends

Lead Time: Standard (All products are manufactured to order and when 'Standard Lead Time' is quoted (7 – 10 days), this may vary dependant on volume ordered, factory capacity and distribution requirements at the time of ordering. For more information please contact your Dealer Business Manager or the Customer Services Team for clarification.)

Wood: Available in MFC (Ash, Autumn Cherry, Beech, Chester Oak, English Walnut, Grey, Grey Nebraska Oak, Laurentii Wenge, Natural Nebraska Oak and White)
Top Panel Edge Detail available on 25mm White MFC (Wenge and Black - Add £32 Retail Per Top) (Plywood - Add £42 Retail Per Top)
Available in Veneer (Oak and Walnut) on a 3 Week Lead Time

Metalwork: Available in Silver RAL 9006 (Standard), Black Graphite RAL 9004, White RAL 9003, Chrome Effect (Add 15%) and Raw finish (Add 5%)



BEXTLH

Bow Extension Meeting Table

- 25mm top panel. • 90mm diameter leg on 300mm diameter base.
- If ordering for use with the Windsor range, suffix .../X.

MFC

BEXTLH - 950w x 1160d x 740h	_____	£712
BEXTRH - 950w x 1160d x 740h	_____	£712



CMT12

Circular Meeting Table

- 25mm top panel. • 90mm diameter leg on 300mm diameter base.
- If ordering for use with the Windsor range, suffix .../X.

MFC

**Veneer
(3 Week
Lead Time)**

CMT12 - 1200w (dia) x 740h	_____	£659	£954
-----------------------------------	-------	------	------



DEXTLH

'D' Ended Extension Meeting Table

- 25mm top panel. • 90mm diameter leg on 300mm diameter base.
- If ordering for use with the Windsor range, suffix .../X.

MFC

**Veneer
(3 Week
Lead Time)**

DEXTLH - 1600w x 800d x 740h	_____	£712	£1,034
DEXTRH - 1600w x 800d x 740h	_____	£712	£1,034



TD12LH

Teardrop Ended Extension Meeting Table

- 25mm top panel. • 90mm diameter leg on 300mm diameter base.
- If ordering for use with the Windsor range, suffix .../X.

MFC

**Veneer
(3 Week
Lead Time)**

TD12LH - 1200w (dia) x 740h	_____	£659	£954
TD12RH - 1200w (dia) x 740h	_____	£659	£954
TD09LH - 900w (dia) x 740h	_____	£605	£873
TD09RH - 900w (dia) x 740h	_____	£605	£873



SET10

Static Eclipse Extension Meeting Table

- 25mm top panel. • 90mm diameter leg on 300mm diameter base.
- Compatible with radius executive and radius crescent desking only.

MFC

**Veneer
(3 Week
Lead Time)**

SET10 - 1000w (dia) x 740h	_____	£653	£940
SET09 - 900w (dia) x 740h	_____	£605	£873

Call Centre



Call Centre offers a highly functional solution, supported by a full steel sub-frame, offering significant levels of strength and stability. The product features a central hub capable of housing complex, high capacity cable installations that can be easily accessed via removable steel panels. The system is practical, flexible and delivers multiple workstations in clusters for improved communication. There are six configurations available for 3, 4, 5, 6 or 8 users. Pedestals can be located over the horizontal section of the supporting leg frames and screen panels are compatible and available in MFC and fabric options to provide privacy, if required. A full range of accessories are compatible including CPU holders, and desktop electrics.

Call Centre Workstations

Lead Time: Standard (All products are manufactured to order and when 'Standard Lead Time' is quoted (7 – 10 days), this may vary dependant on volume ordered, factory capacity and distribution requirements at the time of ordering. For more information please contact your Dealer Business Manager or the Customer Services Team for clarification.)

Wood: Available in MFC (Ash, Autumn Cherry, Beech, Chester Oak, English Walnut, Grey, Grey Nebraska Oak, Laurentii Wenge, Natural Nebraska Oak and White)
Top Panel Edge Detail available on 25mm White MFC (Wenge and Black - Add £32 Retail Per Top) (Plywood - Add £42 Retail Per Top)

Metalwork: Available in Silver RAL 9006 (Standard), Black Graphite RAL 9004 and White RAL 9003



8CC

8 Person Circular Call Centre

• 25mm top panel. • 8 piece top. • Each workspace segment measures 1200w x 1020d.

MFC

8CC - 3135w (extreme) x 3135d (extreme) x 725h | £4,844



6CC

6 Person Circular Call Centre

• 25mm top panel. • 6 piece top. • Each workspace segment measures 1460w x 950d.

MFC

6CC - 2920w (extreme) x 2660d (extreme) x 725h | £3,822



5CC

5 Person Circular Call Centre

• 25mm top panel. • 5 piece top. • Each workspace segment measures 1655w x 860d.

MFC

5CC - 2720w (extreme) x 2625d (extreme) x 725h | £3,280



4CC

4 Person Circular Call Centre

• 25mm top panel. • 4 piece top. • Each workspace segment measures 1920w x 796d.

MFC

4CC - 2710w (extreme) x 2710d (extreme) x 725h | £2,805



4CCH

4 Person Semi-Circular Call Centre

• 25mm top panel. • 4 piece top. • Each workspace segment measures 1200w x 1020d.
• Designed to be positioned against a wall.
• This model will only accept 3x Call Centre pedestals.

MFC

4CCH - 3135w (extreme) x 1568d (extreme) x 725h | £3,121



3CCH

3 Person Semi-Circular Call Centre

• 25mm top panel. • 3 piece top. • Each workspace segment measures 1460w x 950d.
• Designed to be positioned against a wall.
• This model will only accept 2x Call Centre pedestals.

MFC

3CCH - 2920w (extreme) x 1330d (extreme) x 725h | £2,605

Call Centre Pedestals

Lead Time: Standard (All products are manufactured to order and when 'Standard Lead Time' is quoted (7 – 10 days), this may vary dependant on volume ordered, factory capacity and distribution requirements at the time of ordering. For more information please contact your Dealer Business Manager or the Customer Services Team for clarification.)

Wood: Available in MFC (Ash, Autumn Cherry, Beech, Chester Oak, English Walnut, Grey, Grey Nebraska Oak, Laurentii Wenge, Natural Nebraska Oak and White)



CCMPO

Call Centre Open Fronted Narrow Mobile Pedestal

- 25mm top panel.
- Fits over Call Centre legs.
- Open fronted for PC tower storage.
- Ventilated back panel.

MFC

CCMPO - 298w x 600d x 640h
• Open Fronted

£360



CCMPF

Call Centre 3 Drawer Narrow Mobile Pedestal

- 25mm top panel.
- Fits over Call Centre legs.
- Lockable, includes 2x keys.
- Alternative handles available (see page 234-235).

MFC

CCMPF - 298w x 600d x 640h
• 2x Single and 1x Filing Drawers

£360



CCMP4

Call Centre 4 Drawer Narrow Mobile Pedestal

- 25mm top panel.
- Fits over Call Centre legs.
- Lockable, includes 2x keys.
- Alternative handles available (see page 234-235).

MFC

CCMP4 - 298w x 600d x 640h
• 4x Single Drawers

£360



Fixing Plate

Internal Power Module Fixing Plate

- Included as standard on each desk position.
- Can accommodate 2x power modules and 4x data / telecommunication sockets.
- Power modules and data sockets are not included as standard (see page 152).



Call Centre Accessories

Lead Time: Standard (All products are manufactured to order and when 'Standard Lead Time' is quoted (7 – 10 days), this may vary dependant on volume ordered, factory capacity and distribution requirements at the time of ordering. For more information please contact your Dealer Business Manager or the Customer Services Team for clarification.)



Wieland Socket Box

- Compatible with Call Centre workstations only.
- 3.15 amp Individually fused unswitched black sockets.
- Complete with 250mm earth lead to M5 ring terminal.
- Requires a separate mains lead if connecting directly into a socket (see below).

Price

SK2/U/CC - 2 Gang - Black	£41
SK3/U/CC - 3 Gang - Black	£48



Data / Telecommunication Cable and Socket

Price

RJ45/3M - RJ45 Data Cable with 3m Flylead	£31
LJ6BT - LJ6 BT Telecom Socket	£31



Wieland Mains Cable

- Black plug.

Price

7M - 7000w	£31
5M - 5000w	£24
3M - 3000w	£19
2M - 2000w	£17



Wieland Interconnection Cable

- Black interconnection plugs.

Price

CL20 - 2000w	£15
CL10 - 1000w	£13
CL5 - 500w	£12

Call Centre Accessory Compatibility

- **BLACK** - Compatible

Workstations - Circular Call Centre

Workstations - Semi-Circular Call Centre

Accessories	Workstations - Circular Call Centre	Workstations - Semi-Circular Call Centre
Screens		
Call Centre Desk Mounted Screens, page 153	●	●
Power and Data Modules		
Kaspa and Prime, page 309	●	●
Boardroom, Conus and Peak, page 310-312	●	●
Escalate, page 312	●	●
Wireless Charging Unit, page 313	●	●
Port Hole and Pix, page 314	●	●
Pluto and Inca, page 315	●	●
Flex and Capsule, page 316-317	●	●
Plaza and Boost, page 318	●	●
Wieland Socket Boxes, page 319	●	●

Call Centre Contract, System and Acoustic Screens for Call Centres

Lead Time: Standard (All products are manufactured to order and when 'Standard Lead Time' is quoted (7 – 10 days), this may vary dependant on volume ordered, factory capacity and distribution requirements at the time of ordering. For more information please contact your Dealer Business Manager or the Customer Services Team for clarification.)

Metalwork: Available in Anodised Silver (Standard), Black Graphite RAL 9004 and White RAL 9003

Fabric: Fully upholstered with pinnable surface available in Groups 1-7

MFC: Available in Ash, Autumn Cherry, Beech, Chester Oak, English Walnut, Grey, Grey Nebraska Oak, Laurentii Wenge, Natural Nebraska Oak and White

Call Centre Desk Mounted Contract Screen for Call Centres

- Curved or wave dividing screens.
- Screen is bracketed to the centre console.
- Link post not required.

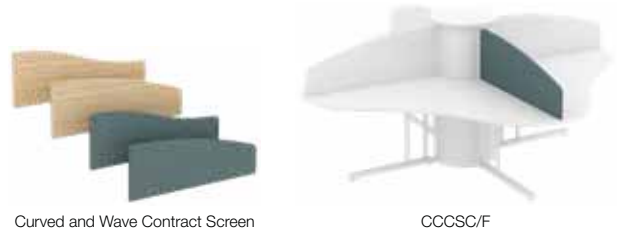

Curved Contract Screen

	Group 1	Group 2	Group 3	Group 4	Group 5	Group 6	Group 7	MFC
CCCSC/F - 1070w x 27d x 400-200h	£288	£300	£312	£324	£336	£348	£360	-
CCSC/MFC - 1070w x 25d x 400-200h	-	-	-	-	-	-	-	£128

Wave Contract Screen

CCCWSW/F - 1070w x 27d x 400-200h	£288	£300	£312	£324	£336	£348	£360	-
CCSW/MFC - 1070w x 25d x 400-200h	-	-	-	-	-	-	-	£128

Elite Desk Mounted System Screen for Call Centres

- Curved or wave dividing screens.
- Screen is bracketed to the centre console.
- Link post not required.



Curved System Screen

	Group 1	Group 2	Group 3	Group 4	Group 5	Group 6	Group 7
ECCSSC/F - 1070w x 27d x 400-200h	£366	£378	£390	£402	£414	£426	£438

Wave System Screen

ECCSSW/F - 1070w x 27d x 400-200h	£366	£378	£390	£402	£414	£426	£438
--	------	------	------	------	------	------	------

Elite Desk Mounted Acoustic Screen for Call Centres

- Curved and wave dividing screens faced with 6mm polyester fibre insulation board.
- Screen is bracketed to the centre console.
- Link post not required.

• Class B certified in accordance with International Standards:

- ISO 354:2003
- ISO 11654:1997
- ISO 9613-1:1993

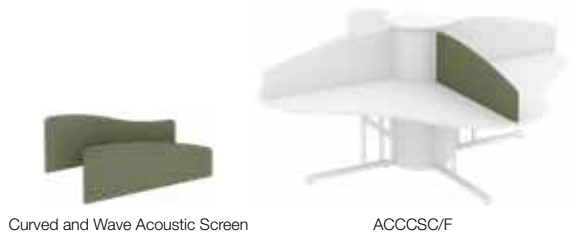

Curved Acoustic Screen

	Group 1	Group 2	Group 3	Group 4	Group 5	Group 6	Group 7
ACCCSC/F - 1070w x 38d x 400-200h	£457	£469	£481	£493	£505	£517	£529

Wave Acoustic Screen

ACCCSW/F - 1070w x 38d x 400-200h	£457	£469	£481	£493	£505	£517	£529
--	------	------	------	------	------	------	------

Interact



With the emerging trend to promote collaborative working, the aim of Interact is to provide you with an agile, dynamic and interactive workspace solution that benefits from easy and reliable connectivity of all personal devices and meets the high standard expected from workspace furniture today. Interact creates a positive first impression with customers and an area to share visual information with clients and colleagues. In addition, it provides technology enabled boardroom environments where colleagues can discuss ideas and collaborate around a shared screen and instant meeting spaces with no impact on existing infrastructure. The business and education community are embracing the collaborative approach as part of their agile working methods, with the possibility of accommodating between 4 and 10 people. The primary focus being around improving the productivity of meetings.

Lead Time: 6 Weeks

Wood: Available in MFC (Ash, Autumn Cherry, Beech, Chester Oak, English Walnut, Grey, Grey Nebraska Oak, Laurentii Wenge, Natural Nebraska Oak and White)
 Top Panel Edge Detail available on 25mm White MFC (Wenge and Black - Add £32 Retail Per Top) (Plywood - Add £42 Retail Per Top)

Metalwork: Available in Silver RAL 9006 (Standard), Black Graphite RAL 9004 and White RAL 9003 - Foot and Lower Support Rail in Black Graphite RAL 9004 (Standard)



IB08/L

Interact Blade Table

- 25mm top panel. • 6 week lead time. • Encourages group focus towards the screens.
- Two height options available (730mm and 1050mm). • Optional CPU storage.
- Table top supplied with 80mm cable port for surface cable connectivity.
- 2x power included within the leg upright (2x 3.15a sockets).
- Secure TV bracket included and accommodates screens up to a maximum of 65".
- Standard interface plate provides four cable options (see page 156).

	MFC
IB08/L - For 8 People - 1445w x 2905d x 730h _____	£13,448
IB06/L - For 6 People - 1420w x 2300d x 730h _____	£10,729
IB04/L - For 4 People - 1420w x 1950d x 730h _____	£10,188
IB08/H - For 8 People - 1445w x 2905d x 1050h _____	£13,448
IB06/H - For 6 People - 1420w x 2300d x 1050h _____	£10,729
IB04/H - For 4 People - 1420w x 1950d x 1050h _____	£10,188



IP06/L

Interact Spectrum Table

- 25mm top panel. • 6 week lead time. • Ergonomically designed and promotes group focus.
- Two height options available (730mm and 1050mm). • Optional CPU storage.
- Table top supplied with 80mm cable port for surface cable connectivity.
- 2x power included within the leg upright (2x 3.15a sockets).
- Secure TV bracket included and accommodates screens up to a maximum of 65".
- Standard interface plate provides four cable options (see page 156).

	MFC
IP09/L - For 9 People - 2028w x 3072d x 730h _____	£13,448
IP06/L - For 6 People - 1440w x 1924d x 730h _____	£10,729
IP06/H - For 6 People - 1440w x 1924d x 1050h _____	£10,729



IQ08/L

Interact Quad Table

- 25mm top panel. • 6 week lead time. • Classic shape, ideal for face-to-face meetings.
- Two height options available (730mm and 1050mm). • Optional CPU storage.
- Table top supplied with 80mm cable port for surface cable connectivity.
- 2x power included within the leg upright (2x 3.15a sockets).
- Secure TV bracket included and accommodates screens up to a maximum of 65".
- Standard interface plate provides four cable options (see page 156).

	MFC
IQ10/L - For 10 People - 1500w x 3661d x 730h _____	£14,263
IQ08/L - For 8 People - 1020w x 3111d x 730h _____	£13,448
IQ06/L - For 6 People - 1020w x 2421d x 730h _____	£10,729
IQ04/L - For 4 People - 1020w x 1772d x 730h _____	£10,188
IQ10/H - For 10 People - 1500w x 3661d x 1050h _____	£14,263
IQ08/H - For 8 People - 1020w x 3111d x 1050h _____	£13,448
IQ06/H - For 6 People - 1020w x 2421d x 1050h _____	£10,729
IQ04/H - For 4 People - 1020w x 1772d x 1050h _____	£10,188

Lead Time: 6 Weeks



Standard Data Interface Plate

Standard Data Interface Plate

- 1x power outlet
- 4x USB connections
- 1x switcher for connectivity leads within the desktop.



Standard Cable Port

Standard Cable Port

- Cables will be situated within the Interact table cable tray and will be accessible via the 80mm cable port.
- 4x connectivity leads within the desktop
- 1x space for on-board PC USB connections from PC if required.

Standard Configuration

- 1x HDMI
- 1x Mini Display Port
- 1x USB (Type C)
- 1x USB (Lightning)

Lead Time: 6 Weeks

Metalwork: Available in Silver RAL 9006 (Standard), Black Graphite RAL 9004 and White RAL 9003



I/CPU

Adjustable Non Lockable CPU Holder

- 6 week lead time.
- Secures to the underside of the table.
- Width and height adjustable / non locking.
- Steel fabricated CPU holder.

I/CPU - 145-220w x 460d x 325-500h

Price

£67



I/CPUL

Lockable CPU Holder

- 6 week lead time.
- Lockable, includes 2x keys.
- Client to provide CPU dimensions as this unit is manufactured to order requirements.
- Secures to the underside of the table.
- Steel fabricated CPU holder.
- High security lock.

I/CPUL

Price

£201

Interact Accessory Compatibility

● GREEN - Unspecified

Tables - Blade

Tables - Plectrum

Tables - Quad

Power and Data Modules	Blade	Plectrum	Quad
Kaspa and Prime, page 309	●	●	●
Boardroom, Conus and Peak, page 310-312	●	●	●
Escalate, page 312	●	●	●
Wireless Charging Unit, page 313	●	●	●
Port Hole and Pix, page 314	●	●	●
Pluto and Inca, page 315	●	●	●
Flex and Capsule, page 316-317	●	●	●
Plaza and Boost, page 318	●	●	●
Wieland Socket Boxes, page 319	●	●	●

Reception



For the environment your visitors first encounter, it's important the reception area captures your organisation's culture and vision.

New to the Reception portfolio, Connect provides the freedom to create a unique arrangement that takes advantage of the space available, combining an alliance between the practicality and visual appearance of the reception desk. A range of 19 modular units, available in multiple configurations, naturally incorporates all the aspects needed to ensure compliance with accessibility and visitors of all capabilities.

For a less bespoke offering, our reception portfolio also offers 3 standalone units that take inspiration from the design of our core furniture range, Windsor.

Reception Connect Examples

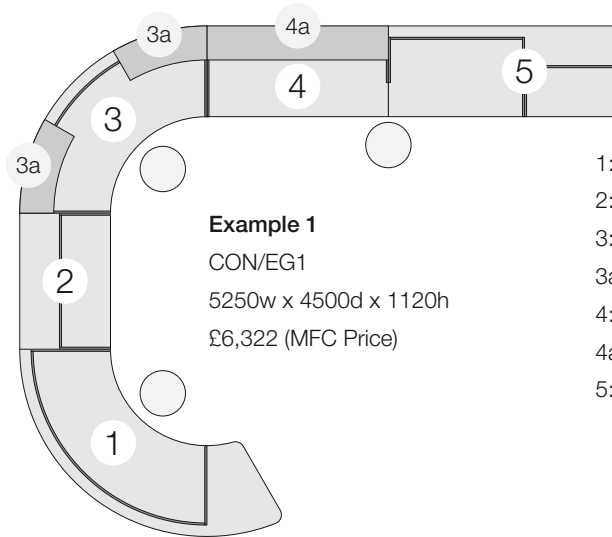

Example 1
CON/EG1
5250w x 4500d x 1120h
£6,322 (MFC Price)

- | | | |
|-----|----------------|--|
| 1: | CONCV/AELH | Curved Workstation with Accessibility Extension |
| 2: | CONR12/AE | Rectangular Workstation with Accessibility Extension |
| 3: | CONCV | Curved Workstation |
| 3a: | CON/CTCV/T38 | Curved Third Counter Top |
| 4: | CONR16/INTLH | Rectangular Workstation with Inset Leg |
| 4a: | CON/CTR16/38 | Rectangular Counter Top |
| 5: | CONR20/INTASRH | Rectangular Workstation with Inset Leg and Accessibility Section |

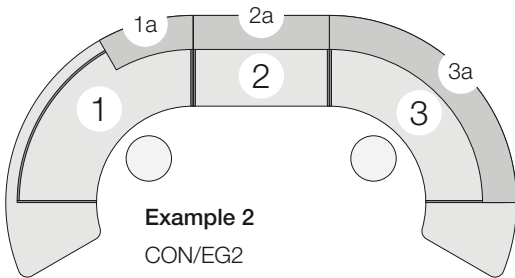

Example 2
CON/EG2
4500w x 2300d x 1220h
£5,118 (MFC Price)

- | | | |
|-----|--------------|---|
| 1: | CONCV/AELH | Curved Workstation with Accessibility Extension |
| 1a: | CON/CTCV/T38 | Curved Third Counter Top |
| 2: | CONR12 | Rectangular Workstation |
| 2a: | CON/CTR12/38 | Rectangular Counter Top |
| 3: | CONCV/AERH | Curved Workstation with Accessibility Extension |
| 3a: | CON/CTCV/F38 | Curved Full Counter Top |

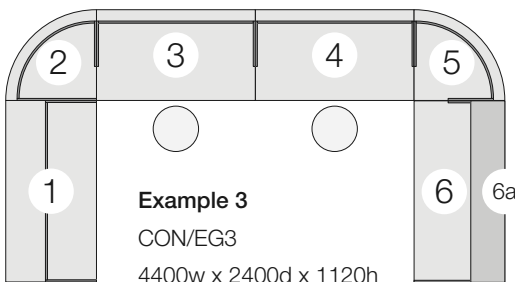

Example 3
CON/EG3
4400w x 2400d x 1120h
£4,668 (MFC Price)

- | | | |
|-----|--------------|--|
| 1: | CONR16/AE | Rectangular Workstation with Accessibility Extension |
| 2: | CONCN/INTLH | Corner Workstation with Inset Leg |
| 3: | CONR14/INT | Rectangular Workstation with Inset Leg |
| 4: | CONR14/INT | Rectangular Workstation with Double Inset Legs |
| 5: | CONCN/INT | Corner Workstation with Double Inset Legs |
| 6: | CONR16/INTRH | Rectangular Workstation with Inset Leg |
| 6a: | CON/CTR16/38 | Rectangular Counter Top |

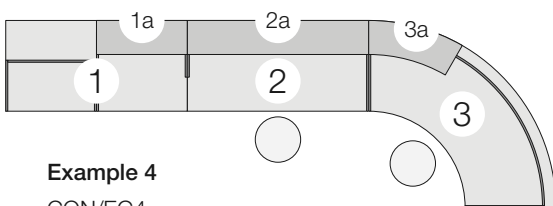

Example 4
CON/EG4
4850w x 1650d x 1220h
£3,883 (MFC Price)

- | | | |
|-----|--------------|--|
| 1: | CONR16/ASLH | Rectangular Workstation with Inset Leg and Accessibility Section |
| 1a: | CON/CTR8/48 | Rectangular Counter Top |
| 2: | CONR16/INTRH | Rectangular Workstation with Inset Leg |
| 2a: | CON/CTR16/48 | Rectangular Counter Top |
| 3: | CONCV | Curved Workstation |
| 3a: | CON/CTCV/T48 | Curved Third Counter Top |

Reception Connect

Lead Time: Standard (All products are manufactured to order and when 'Standard Lead Time' is quoted (7 – 10 days), this may vary dependant on volume ordered, factory capacity and distribution requirements at the time of ordering. For more information please contact your Dealer Business Manager or the Customer Services Team for clarification.)

Wood: Available in MFC (Ash, Autumn Cherry, Beech, Chester Oak, English Walnut, Grey, Grey Nebraska Oak, Laurentii Wenge, Natural Nebraska Oak and White)
Top Panel Edge Detail available on 25mm White MFC (Wenge and Black - Add £32 Retail Per Top) (Plywood - Add £42 Retail Per Top)
Available in Nanotech (Black)

Metalwork: Available in Silver RAL 9006 (Standard), Black Graphite RAL 9004 and White RAL 9003
Also available in Blue RAL 5001, Coral RAL 2001, Green RAL 6016, Light Grey RAL 7038, Teal RAL 5018 and Yellow RAL 1021 (Add 12% for all - 2 Week Lead Time)



Back View



Front View



CONR16

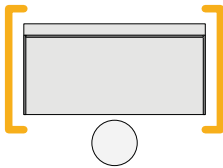

Connect Rectangular Reception Workstation

- 25mm top panel. • Supplied with 2x full depth legs.
- Complete with kick plate (stainless steel only).
- Cable port access between workstations via legs.
- Compatible with MPF and MP3 pedestals only (see page 226).

	MFC	Black Nanotech
CONR20 - 2000w x 800d x 740h	£652	£1,026
CONR18 - 1800w x 800d x 740h	£578	£922
CONR16 - 1600w x 800d x 740h	£548	£864
CONR14 - 1400w x 800d x 740h	£522	£809
CONR12 - 1200w x 800d x 740h	£497	£756
CONR10 - 1000w x 800d x 740h	£473	£703
CONR8 - 800w x 800d x 740h	£445	£647

ORANGE - Can be attached to an adjoining workstation, be the end of sequence or be completely freestanding



CONR16/INT

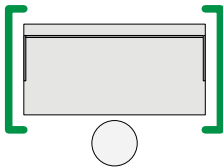

Connect Rectangular Reception Workstation with Double Inset Legs

- **This workstation must be attached to an adjoining workstation on both sides.**
- 25mm top panel. • Supplied with 2x inset legs. • Complete with kick plate (stainless steel only).
- Cable port access between workstations via legs.
- Compatible with MPF and MP3 pedestals only (see page 226).

	MFC	Black Nanotech
CONR20/INT - 2000w x 800d x 740h	£652	£1,026
CONR18/INT - 1800w x 800d x 740h	£578	£922
CONR16/INT - 1600w x 800d x 740h	£548	£864
CONR14/INT - 1400w x 800d x 740h	£522	£809
CONR12/INT - 1200w x 800d x 740h	£497	£756
CONR10/INT - 1000w x 800d x 740h	£473	£703
CONR8/INT - 800w x 800d x 740h	£445	£647

GREEN - Must be attached to an adjoining workstation



CONR16/INTRH

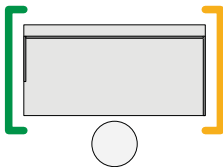

Connect Rectangular Reception Workstation with Inset Leg

- **This workstation must be attached to an adjoining workstation on its left side.**
- 25mm top panel. • Supplied with 1x left side inset leg and 1x right side full depth leg.
- Complete with kick plate (stainless steel only).
- Cable port access between workstations via legs.
- Compatible with MPF and MP3 pedestals only (see page 226).

	MFC	Black Nanotech
CONR20/INTRH - 2000w x 800d x 740h	£652	£1,026
CONR18/INTRH - 1800w x 800d x 740h	£578	£922
CONR16/INTRH - 1600w x 800d x 740h	£548	£864
CONR14/INTRH - 1400w x 800d x 740h	£522	£809
CONR12/INTRH - 1200w x 800d x 740h	£497	£756
CONR10/INTRH - 1000w x 800d x 740h	£473	£703
CONR8/INTRH - 800w x 800d x 740h	£445	£647

GREEN - Must be attached to an adjoining workstation

ORANGE - Can be attached to an adjoining workstation or be the end of sequence

Reception Connect

Lead Time: Standard (All products are manufactured to order and when 'Standard Lead Time' is quoted (7 – 10 days), this may vary dependant on volume ordered, factory capacity and distribution requirements at the time of ordering. For more information please contact your Dealer Business Manager or the Customer Services Team for clarification.)

Wood: Available in MFC (Ash, Autumn Cherry, Beech, Chester Oak, English Walnut, Grey, Grey Nebraska Oak, Laurentii Wenge, Natural Nebraska Oak and White)
Top Panel Edge Detail available on 25mm White MFC (Wenge and Black - Add £32 Retail Per Top) (Plywood - Add £42 Retail Per Top)
Available in Nanotech (Black)

Metalwork: Available in Silver RAL 9006 (Standard), Black Graphite RAL 9004 and White RAL 9003
Also available in Blue RAL 5001, Coral RAL 2001, Green RAL 6016, Light Grey RAL 7038, Teal RAL 5018 and Yellow RAL 1021 (Add 12% for all - 2 Week Lead Time)



CONR16/INTLH

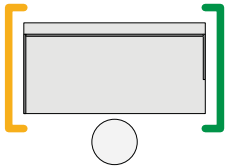

Connect Rectangular Reception Workstation with Inset Leg

- This workstation must be attached to an adjoining workstation on its right side.
- 25mm top panel. • Supplied with 1x left side full depth leg and 1x right side inset leg.
- Complete with kick plate (stainless steel only).
- Cable port access between workstations via legs.
- Compatible with MPF and MP3 pedestals only (see page 226).

	MFC	Black Nanotech
CONR20/INTLH - 2000w x 800d x 740h	£652	£1,026
CONR18/INTLH - 1800w x 800d x 740h	£578	£922
CONR16/INTLH - 1600w x 800d x 740h	£548	£864
CONR14/INTLH - 1400w x 800d x 740h	£522	£809
CONR12/INTLH - 1200w x 800d x 740h	£497	£756
CONR10/INTLH - 1000w x 800d x 740h	£473	£703
CONR8/INTLH - 800w x 800d x 740h	£445	£647

GREEN - Must be attached to an adjoining workstation

ORANGE - Can be attached to an adjoining workstation or be the end of sequence



CONR16/AE

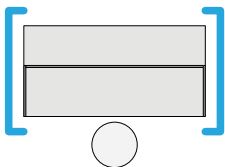

Connect Rectangular Reception Workstation with Accessibility Extension

- This workstation must be attached to an adjoining workstation with a full depth leg on at least one side.
- 25mm top panel. • Compliant with the Equality Act. • Designed for wheelchair visitor access.
- Supplied with 2x AE legs. • Complete with kick plate (stainless steel only).
- Not compatible with Connect Rectangular Reception Counter Tops.

	MFC	Black Nanotech
CONR20/AE - 2000w x 800d x 740h	£652	£1,026
CONR18/AE - 1800w x 800d x 740h	£578	£922
CONR16/AE - 1600w x 800d x 740h	£548	£864
CONR14/AE - 1400w x 800d x 740h	£522	£809
CONR12/AE - 1200w x 800d x 740h	£497	£756
CONR10/AE - 1000w x 800d x 740h	£473	£703
CONR8/AE - 800w x 800d x 740h	£445	£647

BLUE - One side must be attached to an adjoining workstation



Reception Connect

Lead Time: Standard (All products are manufactured to order and when 'Standard Lead Time' is quoted (7 – 10 days), this may vary dependant on volume ordered, factory capacity and distribution requirements at the time of ordering. For more information please contact your Dealer Business Manager or the Customer Services Team for clarification.)

Wood: Available in MFC (Ash, Autumn Cherry, Beech, Chester Oak, English Walnut, Grey, Grey Nebraska Oak, Laurentii Wenge, Natural Nebraska Oak and White)
Top Panel Edge Detail available on 25mm White MFC (Wenge and Black - Add £32 Retail Per Top) (Plywood - Add £42 Retail Per Top)
Available in Nanotech (Black)

Metalwork: Available in Silver RAL 9006 (Standard), Black Graphite RAL 9004 and White RAL 9003
Also available in Blue RAL 5001, Coral RAL 2001, Green RAL 6016, Light Grey RAL 7038, Teal RAL 5018 and Yellow RAL 1021 (Add 12% for all - 2 Week Lead Time)



Back View



Front View



CONR16/ASRH

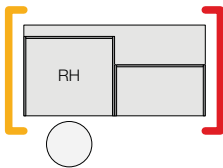

Connect Rectangular Reception Workstation with Accessibility Section

- 25mm top panel. • Compliant with the Equality Act.
- Designed for wheelchair visitor access. • Supplied with 1x AE leg and 2x full depth legs.
- 800w accessibility sections. • Complete with kick plate (stainless steel only).
- Cable port access between workstations via legs.
- Compatible with MPF and MP3 pedestals only (see page 226).
- Connect Rectangular Reception Counter Tops compatible with non-accessibility sections only.

	MFC	Black Nanotech
CONR20/ASRH - 2000w x 800d x 740h	£931	£1,360
CONR18/ASRH - 1800w x 800d x 740h	£905	£1,305
CONR16/ASRH - 1600w x 800d x 740h	£878	£1,249

ORANGE - Can be attached to an adjoining workstation, be the end of sequence or be completely freestanding

RED - Must be the end of the sequence



CONR16/ASLH

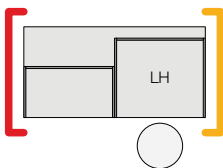

Connect Rectangular Reception Workstation with Accessibility Section

- 25mm top panel. • Compliant with the Equality Act.
- Designed for wheelchair visitor access. • Supplied with 1x AE leg and 2x full depth legs.
- 800w accessibility sections. • Complete with kick plate (stainless steel only).
- Cable port access between workstations via legs.
- Compatible with MPF and MP3 pedestals only (see page 226).
- Connect Rectangular Reception Counter Tops compatible with non-accessibility sections only.

	MFC	Black Nanotech
CONR20/ASLH - 2000w x 800d x 740h	£931	£1,360
CONR18/ASLH - 1800w x 800d x 740h	£905	£1,305
CONR16/ASLH - 1600w x 800d x 740h	£878	£1,249

ORANGE - Can be attached to an adjoining workstation, be the end of sequence or be completely freestanding

RED - Must be the end of the sequence



CONR16/INTASRH

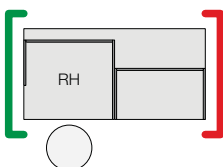

Connect Rectangular Reception Workstation with Inset Leg and Accessibility Section

- **This workstation must be attached to an adjoining workstation on its Left side.**
- 25mm top panel. • Compliant with the Equality Act. • Designed for wheelchair visitor access.
- Supplied with 1x left side inset leg, 1x middle full depth leg and 1x right side AE leg.
- 800w accessibility sections. • Complete with kick plate (stainless steel only).
- Cable port access between workstations via legs.
- Compatible with MPF and MP3 pedestals only (see page 226).
- Connect Rectangular Reception Counter Tops compatible with non-accessibility sections only.

	MFC	Black Nanotech
CONR20/INTASRH - 2000w x 800d x 740h	£931	£1,360
CONR18/INTASRH - 1800w x 800d x 740h	£905	£1,305
CONR16/INTASRH - 1600w x 800d x 740h	£878	£1,249

GREEN - Must be attached to an adjoining workstation

RED - Must be the end of the sequence

Reception Connect

Lead Time: Standard (All products are manufactured to order and when 'Standard Lead Time' is quoted (7 – 10 days), this may vary dependant on volume ordered, factory capacity and distribution requirements at the time of ordering. For more information please contact your Dealer Business Manager or the Customer Services Team for clarification.)

Wood: Available in MFC (Ash, Autumn Cherry, Beech, Chester Oak, English Walnut, Grey, Grey Nebraska Oak, Laurentii Wenge, Natural Nebraska Oak and White) Top Panel Edge Detail available on 25mm White MFC (Wenge and Black - Add £32 Retail Per Top) (Plywood - Add £42 Retail Per Top) Available in Nanotech (Black)

Metalwork: Available in Silver RAL 9006 (Standard), Black Graphite RAL 9004 and White RAL 9003 Also available in Blue RAL 5001, Coral RAL 2001, Green RAL 6016, Light Grey RAL 7038, Teal RAL 5018 and Yellow RAL 1021 (Add 12% for all - 2 Week Lead Time)



CONR16/INTASLH

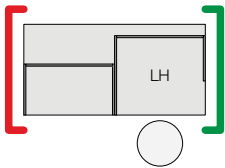

Connect Rectangular Reception Workstation with Inset Leg and Accessibility Section

- This workstation must be attached to an adjoining workstation on its right side.
- 25mm top panel. • Compliant with the Equality Act. • Designed for wheelchair visitor access.
- Supplied with 1x left side AE leg, 1x middle full depth leg and 1x right side inset leg.
- 800w accessibility sections. • Complete with kick plate (stainless steel only).
- Cable port access between workstations via legs.
- Compatible with MPF and MP3 pedestals only (see page 226).
- Connect Rectangular Reception Counter Tops compatible with non-accessibility sections only.

	MFC	Black Nanotech
CONR20/INTASLH - 2000w x 800d x 740h	£931	£1,360
CONR18/INTASLH - 1800w x 800d x 740h	£905	£1,305
CONR16/INTASLH - 1600w x 800d x 740h	£878	£1,249

GREEN - Must be attached to an adjoining workstation

RED - Must be the end of the sequence



CON/CTR16/38

Connect Rectangular Counter Tops for Rectangular Workstations

- Workstation desktop needs to be removed to attach this product securely.
- 25mm top panel. • Desktops are part drilled to accommodate reception counter tops.
- Compatible with Connect Rectangular Reception Workstations at the same width only.

	MFC	Black Nanotech
CON/CTR20/48 - 2000w x 280d x 480h	£263	£416
CON/CTR18/48 - 1800w x 280d x 480h	£250	£390
CON/CTR16/48 - 1600w x 280d x 480h	£240	£366
CON/CTR14/48 - 1400w x 280d x 480h	£227	£339
CON/CTR12/48 - 1200w x 280d x 480h	£214	£315
CON/CTR10/48 - 1000w x 280d x 480h	£205	£292
CON/CTR8/48 - 800w x 280d x 480h	£192	£265
CON/CTR20/38 - 2000w x 280d x 380h	£250	£381
CON/CTR18/38 - 1800w x 280d x 380h	£240	£358
CON/CTR16/38 - 1600w x 280d x 380h	£228	£336
CON/CTR14/38 - 1400w x 280d x 380h	£218	£315
CON/CTR12/38 - 1200w x 280d x 380h	£207	£293
CON/CTR10/38 - 1000w x 280d x 380h	£195	£268
CON/CTR8/38 - 800w x 280d x 380h	£184	£246



CON/CTR16/38

Connect Rectangular Counter Tops for Rectangular Workstations with Accessibility Section

- Workstation desktop needs to be removed to attach this product securely.
- 25mm top panel. • Desktops are part drilled to accommodate reception counter tops.
- Compatible on non-accessibility section on Connect Rectangular Reception Workstations with Accessibility Section only.

	MFC	Black Nanotech
CON/CTR12/48 - For 2000w Workstations - 1200w x 280d x 480h	£214	£315
CON/CTR10/48 - For 1800w Workstations - 1000w x 280d x 480h	£205	£292
CON/CTR8/48 - For 1600w Workstations - 800w x 280d x 480h	£192	£265
CON/CTR12/38 - For 2000w Workstations - 1200w x 280d x 380h	£207	£293
CON/CTR10/38 - For 1800w Workstations - 1000w x 280d x 380h	£195	£268
CON/CTR8/38 - For 1600w Workstations - 800w x 280d x 380h	£184	£246



OF9
Illustrated in red

Connect Cable Tray

- Cable trays are 100mm deep and 110mm high.
- Not compatible with Curved or Corner Workstations.

	Metalwork
OF13 - For 2000w Rectangular Reception Workstations - 1775w	£101
OF12 - For 1800w Rectangular Reception Workstations - 1675w	£88
OF11 - For 1600w Rectangular Reception Workstations - 1475w	£75
OF9 - For 1400w Rectangular Reception Workstations - 1275w	£69
OF7 - For 1200w Rectangular Reception Workstations - 1075w	£60
OF5 - For 1000w Rectangular Reception Workstations - 900w	£57
OF3 - For 800w Rectangular Reception Workstations - 755w	£54

Reception Connect

Lead Time: Standard (All products are manufactured to order and when 'Standard Lead Time' is quoted (7 – 10 days), this may vary dependant on volume ordered, factory capacity and distribution requirements at the time of ordering. For more information please contact your Dealer Business Manager or the Customer Services Team for clarification.)

Wood: Available in MFC (Ash, Autumn Cherry, Beech, Chester Oak, English Walnut, Grey, Grey Nebraska Oak, Laurentii Wenge, Natural Nebraska Oak and White)
Top Panel Edge Detail available on 25mm White MFC (Wenge and Black - Add £32 Retail Per Top) (Plywood - Add £42 Retail Per Top)
Available in Nanotech (Black)

Metalwork: Available in Silver RAL 9006 (Standard), Black Graphite RAL 9004 and White RAL 9003
Also available in Blue RAL 5001, Coral RAL 2001, Green RAL 6016, Light Grey RAL 7038, Teal RAL 5018 and Yellow RAL 1021 (Add 12% for all - 2 Week Lead Time)



Back View



Front View



CONCV

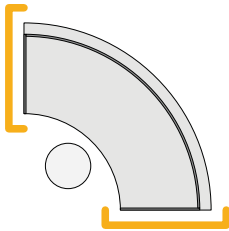

Connect Curved Reception Workstation

- 25mm top panel. • Supplied with 2x full depth legs.
- Complete with kick plate (stainless steel only). • Cable port access between workstations via legs.
- Connect Curved Reception Counter Tops compatible with this product.
- Pedestals not compatible with this product. • Delivered part assembled.
- Nanotech Curved Workstations will have Nanotech top and sides and require a specified standard MFC finish for the front curved panel.

CONCV - 1650w x 1650d x 740h

MFC

**Black
Nanotech
with MFC**

£1,340

£1,964

ORANGE - Can be attached to an adjoining workstation, be the end of sequence or be completely freestanding



CONCV/AERH

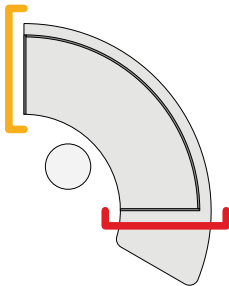

Connect Curved Reception Workstation with Accessibility Extension

- 25mm top panel. • Compliant with the Equality Act.
- Designed for wheelchair visitor access. • Supplied with 2x full depth legs.
- Complete with kick plate (stainless steel only).
- Cable port access between workstations via legs.
- Connect Curved Reception Counter Tops compatible with this product.
- Pedestals not compatible with this product. • Delivered part assembled.
- Nanotech Curved Workstations will have Nanotech top and sides and require a specified standard MFC finish for the front curved panel.

CONCV/AERH - 2300w x 1650d x 740h

CONCV/AELH - 2300w x 1650d x 740h

MFC

**Black
Nanotech
with MFC**

£1,478

£2,177

£1,478

£2,177

ORANGE - Can be attached to an adjoining workstation, be the end of sequence or be completely freestanding

RED - Must be the end of the sequence

Reception Connect

Lead Time: Standard (All products are manufactured to order and when 'Standard Lead Time' is quoted (7 – 10 days), this may vary dependant on volume ordered, factory capacity and distribution requirements at the time of ordering. For more information please contact your Dealer Business Manager or the Customer Services Team for clarification.)

Wood: Available in MFC (Ash, Autumn Cherry, Beech, Chester Oak, English Walnut, Grey, Grey Nebraska Oak, Laurentii Wenge, Natural Nebraska Oak and White)
Top Panel Edge Detail available on 25mm White MFC (Wenge and Black - Add £32 Retail Per Top) (Plywood - Add £42 Retail Per Top)
Available in Nanotech (Black)

Metalwork: Available in Silver RAL 9006 (Standard), Black Graphite RAL 9004 and White RAL 9003
Also available in Blue RAL 5001, Coral RAL 2001, Green RAL 6016, Light Grey RAL 7038, Teal RAL 5018 and Yellow RAL 1021 (Add 12% for all - 2 Week Lead Time)



Back View



Front View



CONCN/INT

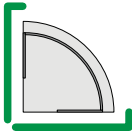

Connect Corner Reception Workstation with Double Inset Legs

• This workstation must be attached to an adjoining workstation on both sides.

- 25mm top panel. • Supplied with 2x inset legs. • Complete with kick plate (stainless steel only).
- Cable port access between workstations via legs. • Delivered assembled.
- Nanotech Curved Workstations will have Nanotech top and sides and require a specified standard MFC finish for the front curved panel.

CONCN/INT - 800w x 800d x 740h | £1,150 **MFC** **Black Nanotech with MFC** £1,355

GREEN - Must be attached to an adjoining workstation



CONCN/INTRH

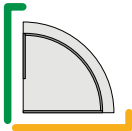

Connect Corner Reception Workstation with Inset Leg

• This workstation must be attached to an adjoining workstation on its left side.

- 25mm top panel. • Supplied with 1x left side inset leg and 1x right side full depth leg.
- Complete with kick plate (stainless steel only). • Cable port access between workstations via legs.
- Delivered assembled.
- Nanotech Curved Workstations will have Nanotech top and sides and require a specified standard MFC finish for the front curved panel.

CONCN/INTRH - 800w x 800d x 740h | £1,150 **MFC** **Black Nanotech with MFC** £1,355

GREEN - Must be attached to an adjoining workstation

ORANGE - Can be attached to an adjoining workstation or be the end of sequence



CONCN/INTLH



Connect Corner Reception Workstation with Inset Leg

• This workstation must be attached to an adjoining workstation on its right side.

- 25mm top panel. • Supplied with 1x left side full depth leg and 1x right side inset leg.
- Complete with kick plate (stainless steel only). • Cable port access between workstations via legs.
- Delivered assembled.
- Nanotech Curved Workstations will have Nanotech top and sides and require a specified standard MFC finish for the front curved panel.

CONCN/INTLH - 800w x 800d x 740h | £1,150 **MFC** **Black Nanotech with MFC** £1,355

GREEN - Must be attached to an adjoining workstation

ORANGE - Can be attached to an adjoining workstation or be the end of sequence

Reception Connect

Lead Time: Standard (All products are manufactured to order and when 'Standard Lead Time' is quoted (7 – 10 days), this may vary dependant on volume ordered, factory capacity and distribution requirements at the time of ordering. For more information please contact your Dealer Business Manager or the Customer Services Team for clarification.)

Wood: Available in MFC (Ash, Autumn Cherry, Beech, Chester Oak, English Walnut, Grey, Grey Nebraska Oak, Laurentii Wenge, Natural Nebraska Oak and White)
Top Panel Edge Detail available on 25mm White MFC (Wenge and Black - Add £32 Retail Per Top) (Plywood - Add £42 Retail Per Top)
Available in Nanotech (Black)

Metalwork: Available in Silver RAL 9006 (Standard), Black Graphite RAL 9004 and White RAL 9003
Also available in Blue RAL 5001, Coral RAL 2001, Green RAL 6016, Light Grey RAL 7038, Teal RAL 5018 and Yellow RAL 1021 (Add 12% for all - 2 Week Lead Time)



CON/CTCV/F38

Connect Curved Reception Counter Tops

- **Workstation desktop needs to be removed to attach this product securely.**
- 25mm top panel. • Desktops are part drilled to accommodate reception counter tops.
- Compatible with Connect Curved Reception Workstations.
- Nanotech Curved Workstations will have Nanotech top and sides and require a specified standard MFC finish for the front curved panel.

	MFC	Black Nanotech with MFC
CON/CTCV/F48 - 2335w (extreme) x 280d x 480h	£861	£1,126
CON/CTCV/F38 - 2335w (extreme) x 280d x 380h	£808	£1,067



CON/CTCV/T38

Connect Curved Reception Third Counter Tops

- **Workstation desktop needs to be removed to attach this product securely.**
- 25mm top panel. • Desktops are part drilled to accommodate reception counter tops.
- Compatible with Connect Curved Reception Workstations.
- Nanotech Curved Workstations will have Nanotech top and sides and require a specified standard MFC finish for the front curved panel.

	MFC	Black Nanotech with MFC
CON/CTCV/T48 - 850w (extreme) x 280d x 480h	£685	£744
CON/CTCV/T38 - 850w (extreme) x 280d x 380h	£650	£709



CON/CTCN38

Connect Corner Reception Counter Tops

- **Workstation desktop needs to be removed to attach this product securely.**
- 25mm top panel. • Desktops are part drilled to accommodate reception counter tops.
- Compatible with Connect Corner Reception Workstations.
- Nanotech Curved Workstations will have Nanotech top and sides and require a specified standard MFC finish for the front curved panel.

	MFC	Black Nanotech with MFC
CON/CTCN/48 - 1140w x 280d x 480h	£720	£813
CON/CTCN/38 - 1140w x 280d x 380h	£668	£755

Reception Windsor

Lead Time: Standard (All products are manufactured to order and when 'Standard Lead Time' is quoted (7 – 10 days), this may vary dependant on volume ordered, factory capacity and distribution requirements at the time of ordering. For more information please contact your Dealer Business Manager or the Customer Services Team for clarification.)

Wood: Available in MFC (Ash, Autumn Cherry, Beech, Chester Oak, English Walnut, Grey, Grey Nebraska Oak, Laurentii Wenge, Natural Nebraska Oak and White)
Top Panel Edge Detail available on 25mm White MFC (Wenge and Black - Add £32 Retail Per Top) (Plywood - Add £42 Retail Per Top)
Available in Veneer (Oak and Walnut) on a 3 Week Lead Time

Metalwork: Available in Silver RAL 9006 (Standard), Black Graphite RAL 9004 and White RAL 9003



WRU18RH

Windsor Bow Fronted Reception Workstation

- 25mm top panel. • 600mm return. • Desktop is 745mm high.

	MFC	Veneer (3 Week Lead Time)
WRU20LH - 2000w x 1350d x 1100h	£2,047	£3,172
WRU20RH - 2000w x 1350d x 1100h	£2,047	£3,172
WRU18LH - 1800w x 1350d x 1100h	£1,962	£3,042
WRU18RH - 1800w x 1350d x 1100h	£1,962	£3,042



RRRH

Windsor Radius Reception Desk with DDA Extension

- 25mm top panel. • Designed for wheelchair visitor access.
- Complete with kick plate (stainless steel only).
- Delivered assembled. • Desktop is 745mm high.

	MFC	Veneer (3 Week Lead Time)
RRLH - 2800w (extreme) x 800d x 745h	£2,537	£3,933
RRRH - 2800w (extreme) x 800d x 745h	£2,537	£3,933



RR

Windsor Radius Reception Desk

- 25mm top panel. • Complete with kick plate (stainless steel only).
- Delivered assembled. • Desktop is 745mm high.

	MFC	Veneer (3 Week Lead Time)
RR - 1915w (extreme) x 800d x 745h	£2,214	£3,438



DCTC

Windsor Curved Double Counter Top

- 25mm top panel. • Windsor curved double counter top does not sit flush either end of Windsor radius reception desks due to its fixings.

	MFC	Veneer (3 Week Lead Time)
DCT - 1800w (extreme) x 240d x 380h	£1,971	£3,053



SCTC

Windsor Curved Single Counter Top

- 25mm top panel. • Windsor curved single counter top can be positioned left, centre or right of the reception desk.

	MFC	Veneer (3 Week Lead Time)
SCT - 980w x 240d x 380h	£1,044	£1,618

Reception Accessories

Lead Time: Standard (All products are manufactured to order and when 'Standard Lead Time' is quoted (7 – 10 days), this may vary dependant on volume ordered, factory capacity and distribution requirements at the time of ordering. For more information please contact your Dealer Business Manager or the Customer Services Team for clarification.)

Wood: Available in MFC (Ash, Autumn Cherry, Beech, Chester Oak, English Walnut, Grey, Grey Nebraska Oak, Laurentii Wenge, Natural Nebraska Oak and White)
 Top Panel Edge Detail available on 25mm White MFC (Wenge and Black - Add £32 Retail Per Top) (Plywood - Add £42 Retail Per Top)
 Available in Veneer (Oak and Walnut) on a 3 Week Lead Time

Metalwork: Available in Silver RAL 9006 (Standard), Black Graphite RAL 9004 and White RAL 9003



RSG14

Oval Reception Shelf

- Available in MFC or glass. • MFC version made with 25mm top panel.
- Glass version made from 10mm toughened clear glass.

	MFC	Veneer (3 Week Lead Time)	Glass
RS14 - 1400w x 300d x 225h	£391	£566	-
RS12 - 1200w x 300d x 225h	£379	£550	-
RS10 - 1000w x 300d x 225h	£370	£537	-
• MFC Oval Shelf			
RSG14 - 1400w x 300d x 215h	-	-	£607
RSG12 - 1200w x 300d x 215h	-	-	£585
RSG10 - 1000w x 300d x 215h	-	-	£566
• Glass Oval Shelf			



RSRH

'L' Shaped Reception Shelf

- Available in MFC or glass.
- Glass version made from 10mm toughened clear glass.
- Compatible with Kassini, Optima Plus and Callisto Reception Desks.

	MFC	Veneer	Glass
RSLH - 1850w x 1650d x 225h	£764	£1,102	-
RSRH - 1850w x 1650d x 225h	£764	£1,102	-
• MFC 'L' Shaped Shelf			
RSLH - 1850w x 1650d x 215h	-	-	£1,026
RSRH - 1850w x 1650d x 215h	-	-	£1,026
• Glass 'L' Shaped Shelf			

Reception Accessory Compatibility

- **BLACK** - Compatible
- **ORANGE** - Non-standard position required
- **GREEN** - Unspecified

Connect - Reception _____

Windsor - Bow Fronted Reception _____

Windsor - Radius Reception _____

Windsor - Radius Reception with Counter Tops _____

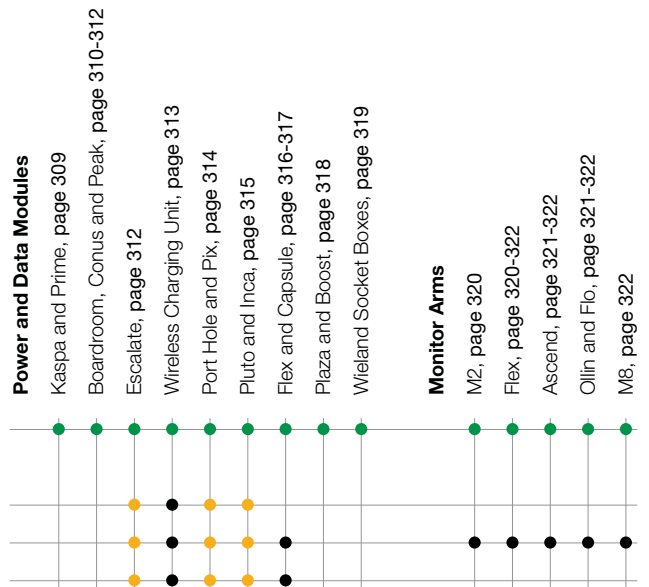

Conference / Meeting



Taking inspiration from our core desking ranges, the Conference / Meeting portfolio delivers solutions and options that offer full flexibility, modern finishes and budgets to suit. Each table within the collection can be specified with wire management options and surface mounted power, data, and USB charging modules.

The introduction of timber framework into the portfolio with Lux Boardroom tables provides clients with a contemporary option to complement their workspace and make a lasting impression.

New for 2021 is a modern approach to boardroom furniture with all the wellbeing benefits of our Progress Plus Sit-Stand range. The elegant conference room table available in two configurations, with height adjustment of 650mm to 1280mm by use of a surface mounted touchpad, capable of accommodating up to 10 or 14 people.

Lead Time: 3 Weeks

Wood: Available in MFC (Ash, Autumn Cherry, Beech, Chester Oak, English Walnut, Grey, Grey Nebraska Oak, Laurentii Wenge, Natural Nebraska Oak and White)
 Top Panel Edge Detail available on 25mm White MFC (Wenge and Black - Add £32 Retail Per Top) (Plywood - Add £42 Retail Per Top)
 Available in Nanotech (Black)

Metalwork: Available in Silver RAL 9006 (Standard), Black Graphite RAL 9004 and White RAL 9003

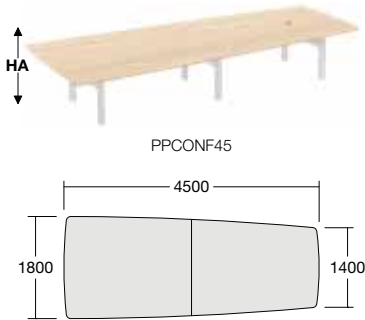

Progress Plus Electric Height Adjustable Half-Barrel Conference Table

- 3 week lead time. • 25mm top panel.
- Sit / stand height adjustment of 650mm-1280mm via electronic up / down keypad situated on the desktop. • Complete with horizontal cable trays. • Anti-collision as standard.

PPCONF45 - 4500w x 1800/1400d x 650-1280h
 • 2x 2250mm Sections • Seating up to 14 People

MFC **Black Nanotech**

£7,823

£8,519

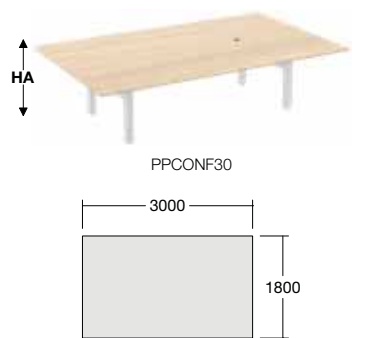

Progress Plus Electric Height Adjustable Rectangular Conference Table

- 3 week lead time. • 25mm top panel.
- Sit / stand height adjustment of 650mm-1280mm via electronic up / down keypad situated on the desktop. • Complete with horizontal cable trays. • Anti-collision as standard.

PPCONF30 - 3000w x 1800d x 650-1280h
 • 1x 3000mm Sections • Seating up to 10 People

MFC

£5,100



Conference / Meeting Aerofoil

Lead Time: Standard (All products are manufactured to order and when 'Standard Lead Time' is quoted (7 – 10 days), this may vary dependant on volume ordered, factory capacity and distribution requirements at the time of ordering. For more information please contact your Dealer Business Manager or the Customer Services Team for clarification.)

Wood: Available in MFC (Ash, Autumn Cherry, Beech, Chester Oak, English Walnut, Grey, Grey Nebraska Oak, Laurentii Wenge, Natural Nebraska Oak and White)
Top Panel Edge Detail available on 25mm White MFC (Wenge and Black - Add £32 Retail Per Top) (Plywood - Add £42 Retail Per Top)
Available in Veneer (Oak and Walnut) on a 3 Week Lead Time

Metalwork: Available in Silver RAL 9006 (Standard), Black Graphite RAL 9004 and White RAL 9003
Also available in Blue RAL 5001, Coral RAL 2001, Green RAL 6016, Light Grey RAL 7038, Teal RAL 5018 and Yellow RAL 1021 (Add 12% for all - 2 Week Lead Time)



ABT40

Aerofoil Boardroom Table

- 2x 25mm top panels.
- Barrel shaped top with elliptical base and silver extruded uprights.
- Horizontal and vertical cable management.

ABT40 - 4000w x 1300d x 740h

- 2x 2000mm Sections
- Seating up to 14 People

ABT38 - 3800w x 1300d x 740h

- 2x 1900mm Sections
- Seating up to 12 People

ABT36 - 3600w x 1300d x 740h

- 2x 1800mm Sections
- Seating up to 12 People

ABT34 - 3400w x 1300d x 740h

- 2x 1700mm Sections
- Seating up to 10 People

ABT32 - 3200w x 1300d x 740h

- 2x 1600mm Sections
- Seating up to 10 People

MFC
Veneer (3 Week Lead Time)

£3,812 £5,525

£3,739 £5,422

£3,668 £5,317

£3,597 £5,214

£3,525 £5,111



ABT28

Aerofoil Boardroom Table

- 25mm top panel.
- Barrel shaped top with elliptical base and silver extruded uprights.
- Horizontal and vertical cable management.

ABT30 - 3000w x 1300d x 740h

- 1x 3000mm Section
- Seating up to 10 People

ABT28 - 2800w x 1300d x 740h

- 1x 2800mm Section
- Seating up to 8 People

ABT26 - 2600w x 1300d x 740h

- 1x 2600mm Section
- Seating up to 8 People

MFC
Veneer (3 Week Lead Time)

£2,688 -

£2,579 -

£2,490 £3,635



Lead Time: 2 Weeks

Wood: Available in MFC (Ash, Autumn Cherry, Beech, Chester Oak, English Walnut, Grey, Grey Nebraska Oak, Laurentii Wenge, Natural Nebraska Oak and White)
Top Panel Edge Detail available on 25mm White MFC (Wenge and Black - Add £32 Retail Per Top) (Plywood - Add £42 Retail Per Top)
Available in Veneer (Oak and Walnut) on a 3 Week Lead Time

Metalwork: Available in Silver RAL 9006 (Standard), Black Graphite RAL 9004 and White RAL 9003

Finishes: Available in the finishes detailed below



LUXOCT2800/ASL

Lux Octagonal Conference Table

- 2 week lead time. • 25mm top panel.
- Tapered legs with adjustable levelling feet and steel sub-frame.

LUXOCT2800... - 2800w x 1200d x 740h _____
• 1x 2800mm Section • Seating up to 10 People

LUXOCT2600... - 2600w x 1200d x 740h _____
• 1x 2600mm Section • Seating up to 8 People

LUXOCT2400... - 2400w x 1000d x 740h _____
• 1x 2400mm Section • Seating up to 8 People

- Add £0 for Ash (.../ASL)
- Add £54 for Stained Walnut (.../WAL)
- Add £62 for Stained Espresso (.../ESL), Wenge (.../WEL) and Black (.../BKL)
- Add £78 for White (.../WHL)

MFC	Veneer (3 Week Lead Time)
-----	---------------------------------

£2,308	-
--------	---

£2,220	£2,663
--------	--------

£2,151	£2,579
--------	--------



LUXMT32/12/ASL

Lux Rectangular Meeting Table

- 2 week lead time. • 2x 25mm top panels.
- Tapered legs with adjustable levelling feet and steel sub-frame.
- Available with radiused corners, suffix .../RC (see page 57).

LUXMT48/14... - 2x Sections - 4800w x 1400d x 740h _____

LUXMT44/14... - 2x Sections - 4400w x 1400d x 740h _____

LUXMT40/14... - 2x Sections - 4000w x 1400d x 740h _____

LUXMT36/14... - 2x Sections - 3600w x 1400d x 740h _____

LUXMT32/14... - 2x Sections - 3200w x 1400d x 740h _____

LUXMT30/14... - 2x Sections - 3000w x 1400d x 740h _____

LUXMT48/12... - 2x Sections - 4800w x 1200d x 740h _____

LUXMT44/12... - 2x Sections - 4400w x 1200d x 740h _____

LUXMT40/12... - 2x Sections - 4000w x 1200d x 740h _____

LUXMT36/12... - 2x Sections - 3600w x 1200d x 740h _____

LUXMT32/12... - 2x Sections - 3200w x 1200d x 740h _____

LUXMT30/12... - 2x Sections - 3000w x 1200d x 740h _____

LUXMT48/10... - 2x Sections - 4800w x 1000d x 740h _____

LUXMT44/10... - 2x Sections - 4400w x 1000d x 740h _____

LUXMT40/10... - 2x Sections - 4000w x 1000d x 740h _____

LUXMT36/10... - 2x Sections - 3600w x 1000d x 740h _____

LUXMT32/10... - 2x Sections - 3200w x 1000d x 740h _____

LUXMT30/10... - 2x Sections - 3000w x 1000d x 740h _____

- Add £0 for Ash (.../ASL)
- Add £81 for Stained Walnut (.../WAL)
- Add £93 for Stained Espresso (.../ESL), Wenge (.../WEL) and Black (.../BKL)
- Add £117 for White (.../WHL)

MFC	Veneer (3 Week Lead Time)
-----	---------------------------------

£3,725	£4,470
--------	--------

£3,596	£4,312
--------	--------

£3,464	£4,158
--------	--------

£3,334	£4,000
--------	--------

£3,202	£3,844
--------	--------

£3,139	£3,766
--------	--------

£3,582	£4,298
--------	--------

£3,451	£4,141
--------	--------

£3,320	£3,986
--------	--------

£3,191	£3,831
--------	--------

£3,060	£3,672
--------	--------

£2,981	£3,594
--------	--------

£3,439	£4,126
--------	--------

£3,308	£3,969
--------	--------

£3,178	£3,814
--------	--------

£3,046	£3,656
--------	--------

£2,918	£3,500
--------	--------

£2,852	£3,422
--------	--------

Lead Time: 2 Weeks

Wood: Available in MFC (Ash, Autumn Cherry, Beech, Chester Oak, English Walnut, Grey, Grey Nebraska Oak, Laurentii Wenge, Natural Nebraska Oak and White)
Top Panel Edge Detail available on 25mm White MFC (Wenge and Black - Add £32 Retail Per Top) (Plywood - Add £42 Retail Per Top)
Available in Veneer (Oak and Walnut) on a 3 Week Lead Time

Metalwork: Available in Silver RAL 9006 (Standard), Black Graphite RAL 9004 and White RAL 9003

Finishes: Available in the finishes detailed below



LUXMT16/12/ASL

Lux Rectangular Meeting Table

- 2 week lead time. • 25mm top panel.
- Tapered legs with adjustable levelling feet and steel sub-frame.
- Available with radiused corners, suffix .../RC (see page 57).

	MFC	Veneer (3 Week Lead Time)
LUXMT28/14... - 1x Section - 2800w x 1400d x 740h	£2,344	-
LUXMT26/14... - 1x Section - 2600w x 1400d x 740h	£2,272	£2,725
LUXMT24/14... - 1x Section - 2400w x 1400d x 740h	£2,197	£2,636
LUXMT22/14... - 1x Section - 2200w x 1400d x 740h	£2,051	£2,459
LUXMT20/14... - 1x Section - 2000w x 1400d x 740h	£1,906	£2,287
LUXMT18/14... - 1x Section - 1800w x 1400d x 740h	£1,757	£2,110
LUXMT16/14... - 1x Section - 1600w x 1400d x 740h	£1,611	£1,933
LUXMT28/12... - 1x Section - 2800w x 1200d x 740h	£2,278	-
LUXMT26/12... - 1x Section - 2600w x 1200d x 740h	£2,205	£2,647
LUXMT24/12... - 1x Section - 2400w x 1200d x 740h	£2,134	£2,561
LUXMT22/12... - 1x Section - 2200w x 1200d x 740h	£1,988	£2,383
LUXMT20/12... - 1x Section - 2000w x 1200d x 740h	£1,839	£2,209
LUXMT18/12... - 1x Section - 1800w x 1200d x 740h	£1,692	£2,030
LUXMT16/12... - 1x Section - 1600w x 1200d x 740h	£1,548	£1,855
LUXMT14/12... - 1x Section - 1400w x 1200d x 740h	£1,482	£1,778
LUXMT28/10... - 1x Section - 2800w x 1000d x 740h	£2,213	-
LUXMT26/10... - 1x Section - 2600w x 1000d x 740h	£2,139	£2,569
LUXMT24/10... - 1x Section - 2400w x 1000d x 740h	£2,067	£2,480
LUXMT22/10... - 1x Section - 2200w x 1000d x 740h	£1,918	£2,302
LUXMT20/10... - 1x Section - 2000w x 1000d x 740h	£1,776	£2,130
LUXMT18/10... - 1x Section - 1800w x 1000d x 740h	£1,628	£1,954
LUXMT16/10... - 1x Section - 1600w x 1000d x 740h	£1,482	£1,778
LUXMT14/10... - 1x Section - 1400w x 1000d x 740h	£1,418	£1,701
LUXMT12/10... - 1x Section - 1200w x 1000d x 740h	£1,350	£1,621

- Add £0 for Ash (.../ASL)
- Add £54 for Stained Walnut (.../WAL)
- Add £62 for Stained Espresso (.../ESL), Wenge (.../WEL) and Black (.../BKL)
- Add £78 for White (.../WHL)



LUXMT16/16/ASL

Lux Square Meeting Table

- 2 week lead time. • 25mm top panel.
- Tapered legs with adjustable levelling feet and steel sub-frame.
- Available with radiused corners, suffix .../RC (see page 57).

	MFC	Veneer (3 Week Lead Time)
LUXMT20/20... - 2000w x 2000d x 740h	£2,014	£2,415
LUXMT18/18... - 1800w x 1800d x 740h	£1,868	£2,240
LUXMT16/16... - 1600w x 1600d x 740h	£1,719	£2,063
LUXMT14/14... - 1400w x 1400d x 740h	£1,572	£1,887
LUXMT12/12... - 1200w x 1200d x 740h	£1,426	£1,710
LUXMT10/10... - 1000w x 1000d x 740h	£1,279	£1,537

- Add £0 for Ash (.../ASL)
- Add £54 for Stained Walnut (.../WAL)
- Add £62 for Stained Espresso (.../ESL), Wenge (.../WEL) and Black (.../BKL)
- Add £78 for White (.../WHL)



LUXMT/CIR16/ASL

Lux Circular Meeting Table

- 2 week lead time. • 25mm top panel.
- Tapered legs with adjustable levelling feet and steel sub-frame.

	MFC	Veneer (3 Week Lead Time)
LUXMT/CIR20... - 2000w (dia) x 740h	£2,124	£2,531
LUXMT/CIR18... - 1800w (dia) x 740h	£1,963	£2,355
LUXMT/CIR16... - 1600w (dia) x 740h	£1,800	£2,161
LUXMT/CIR14... - 1400w (dia) x 740h	£1,675	£2,010
LUXMT/CIR12... - 1200w (dia) x 740h	£1,426	£1,710
LUXMT/CIR10... - 1000w (dia) x 740h	£1,311	£1,572

- Add £0 for Ash (.../ASL)
- Add £54 for Stained Walnut (.../WAL)
- Add £62 for Stained Espresso (.../ESL), Wenge (.../WEL) and Black (.../BKL)
- Add £78 for White (.../WHL)

Conference / Meeting LUX

Lead Time: Standard (All products are manufactured to order and when 'Standard Lead Time' is quoted (7 – 10 days), this may vary dependant on volume ordered, factory capacity and distribution requirements at the time of ordering. For more information please contact your Dealer Business Manager or the Customer Services Team for clarification.)

Metalwork: Available in Silver RAL 9006 (Standard), Black Graphite RAL 9004 and White RAL 9003



LCTR16
Illustrated in red

Lux Cable Tray

- Compatible with all Lux tables.
- High capacity cable management system neatly conceals power, data and telecom cables through a hinged cable management tray. • Cable trays are 180mm deep and 80mm high.

			Metalwork
LCTO28	- For LUXOCT2800	- 1100w (2x)	£218
LCTO26	- For LUXOCT2600	- 1000w (2x)	£208
LCTO24	- For LUXOCT2400	- 900w (2x)	£190
LCTR48	- For 4800w Rectangular Meeting	- 900w (4x)	£380
LCTR44	- For 4400w Rectangular Meeting	- 800w (4x)	£356
LCTR40	- For 4000w Rectangular Meeting	- 1500w (2x)	£250
LCTR36	- For 3600w Rectangular Meeting	- 1300w (2x)	£234
LCTR32	- For 3200w Rectangular Meeting	- 1100w (2x)	£218
LCTR30	- For 3000w Rectangular Meeting	- 1000w (2x)	£208
LCTR28	- For 2800w Rectangular Meeting	- 1100w (2x)	£218
LCTR26	- For 2600w Rectangular Meeting	- 1000w (2x)	£208
LCTR24	- For 2400w Rectangular Meeting	- 900w (2x)	£190
LCTR22	- For 2200w Rectangular Meeting	- 800w (2x)	£178
LCTR20	- For 2000w Rectangular Meeting	- 1500w	£125
LCTR18	- For 1800w Rectangular Meeting	- 1300w	£117
LCTR16	- For 1600w Rectangular Meeting	- 1100w	£109
LCTR14	- For 1400w Rectangular Meeting	- 900w	£95
LCTR12	- For 1200w Rectangular Meeting	- 700w	£81
LCTS20	- For 2000w Square Meeting	- 1500w	£125
LCTS18	- For 1800w Square Meeting	- 1300w	£117
LCTS16	- For 1600w Square Meeting	- 1100w	£109
LCTS14	- For 1400w Square Meeting	- 900w	£95
LCTS12	- For 1200w Square Meeting	- 700w	£81
LCTS10	- For 1000w Square Meeting	- 500w	£64
LCTC18	- For 2000w and 1800w Circular Meeting	- 900w	£95
LCTC16	- For 1600w Circular Meeting	- 800w	£89
LCTC14	- For 1400w Circular Meeting	- 600w	£72
LCTC12	- For 1200w Circular Meeting	- 500w	£64

Lead Time: 2 Weeks

Wood: Available in MFC (Ash, Autumn Cherry, Beech, Chester Oak, English Walnut, Grey, Grey Nebraska Oak, Laurentii Wenge, Natural Nebraska Oak and White)
 Top Panel Edge Detail available on 25mm White MFC (Wenge and Black - Add £32 Retail Per Top) (Plywood - Add £42 Retail Per Top)
 Available in Veneer (Oak and Walnut) on a 3 Week Lead Time

Metalwork: Available in Silver RAL 9006 (Standard), Black Graphite RAL 9004, White RAL 9003, Chrome Effect (Add 15%) and Raw finish (Add 5%)
 Also available in Blue RAL 5001, Coral RAL 2001, Green RAL 6016, Light Grey RAL 7038, Teal RAL 5018 and Yellow RAL 1021 (Add 12% for all)



ROCT3000



ROCT2800

Reflex Octagonal Conference Table

- 2 week lead time. • 25mm top panel. • Shared centre legs on ROCT3000.
- Tapered angled legs with steel sub-frame. • Adjustable levelling feet.

ROCT3000 - 3000w x 1400d x 740h	£3,332	-
• 1x 3000mm Section • Seating up to 10 People		
ROCT2800 - 2800w x 1200d x 740h	£2,308	-
• 1x 2800mm Section • Seating up to 10 People		
ROCT2600 - 2600w x 1200d x 740h	£2,220	£2,663
• 1x 2600mm Section • Seating up to 8 People		
ROCT2400 - 2400w x 1000d x 740h	£2,151	£2,579
• 1x 2400mm Section • Seating up to 8 People		

Veneer (3 Week Lead Time)
MFC



RMT32/12

Reflex Rectangular Meeting Table

- 2 week lead time. • 2x 25mm top panels. • Shared centre legs.
- Tapered angled legs with steel sub-frame. • Adjustable levelling feet.

RMT48/14 - 2x Sections - 4800w x 1400d x 740h	£3,725	£4,470
RMT44/14 - 2x Sections - 4400w x 1400d x 740h	£3,596	£4,312
RMT40/14 - 2x Sections - 4000w x 1400d x 740h	£3,464	£4,158
RMT36/14 - 2x Sections - 3600w x 1400d x 740h	£3,334	£4,000
RMT32/14 - 2x Sections - 3200w x 1400d x 740h	£3,202	£3,844
RMT30/14 - 2x Sections - 3000w x 1400d x 740h	£3,139	£3,766
RMT48/12 - 2x Sections - 4800w x 1200d x 740h	£3,582	£4,298
RMT44/12 - 2x Sections - 4400w x 1200d x 740h	£3,451	£4,141
RMT40/12 - 2x Sections - 4000w x 1200d x 740h	£3,320	£3,986
RMT36/12 - 2x Sections - 3600w x 1200d x 740h	£3,191	£3,831
RMT32/12 - 2x Sections - 3200w x 1200d x 740h	£3,060	£3,672
RMT30/12 - 2x Sections - 3000w x 1200d x 740h	£2,981	£3,594
RMT48/10 - 2x Sections - 4800w x 1000d x 740h	£3,439	£4,126
RMT44/10 - 2x Sections - 4400w x 1000d x 740h	£3,308	£3,969
RMT40/10 - 2x Sections - 4000w x 1000d x 740h	£3,178	£3,814
RMT36/10 - 2x Sections - 3600w x 1000d x 740h	£3,046	£3,656
RMT32/10 - 2x Sections - 3200w x 1000d x 740h	£2,917	£3,500
RMT30/10 - 2x Sections - 3000w x 1000d x 740h	£2,852	£3,422

Veneer (3 Week Lead Time)
MFC



Lead Time: 2 Weeks

Wood: Available in MFC (Ash, Autumn Cherry, Beech, Chester Oak, English Walnut, Grey, Grey Nebraska Oak, Laurentii Wenge, Natural Nebraska Oak and White)
Top Panel Edge Detail available on 25mm White MFC (Wenge and Black - Add £32 Retail Per Top) (Plywood - Add £42 Retail Per Top)
Available in Veneer (Oak and Walnut) on a 3 Week Lead Time

Metalwork: Available in Silver RAL 9006 (Standard), Black Graphite RAL 9004, White RAL 9003, Chrome Effect (Add 15%) and Raw finish (Add 5%)
Also available in Blue RAL 5001, Coral RAL 2001, Green RAL 6016, Light Grey RAL 7038, Teal RAL 5018 and Yellow RAL 1021 (Add 12% for all)



RMT16/12

Reflex Rectangular Meeting Table

- 2 week lead time. • 25mm top panel.
- Tapered angled legs with steel sub-frame. • Adjustable levelling feet.

	MFC	Veneer (3 Week Lead Time)
RMT28/14 - 1x Section - 2800w x 1400d x 740h	£2,344	-
RMT26/14 - 1x Section - 2600w x 1400d x 740h	£2,272	£2,725
RMT24/14 - 1x Section - 2400w x 1400d x 740h	£2,197	£2,636
RMT22/14 - 1x Section - 2200w x 1400d x 740h	£2,051	£2,459
RMT20/14 - 1x Section - 2000w x 1400d x 740h	£1,906	£2,287
RMT18/14 - 1x Section - 1800w x 1400d x 740h	£1,757	£2,110
RMT16/14 - 1x Section - 1600w x 1400d x 740h	£1,611	£1,933
RMT28/12 - 1x Section - 2800w x 1200d x 740h	£2,278	-
RMT26/12 - 1x Section - 2600w x 1200d x 740h	£2,205	£2,647
RMT24/12 - 1x Section - 2400w x 1200d x 740h	£2,134	£2,561
RMT22/12 - 1x Section - 2200w x 1200d x 740h	£1,988	£2,383
RMT20/12 - 1x Section - 2000w x 1200d x 740h	£1,839	£2,209
RMT18/12 - 1x Section - 1800w x 1200d x 740h	£1,692	£2,030
RMT16/12 - 1x Section - 1600w x 1200d x 740h	£1,548	£1,855
RMT14/12 - 1x Section - 1400w x 1200d x 740h	£1,482	£1,778
RMT28/10 - 1x Section - 2800w x 1000d x 740h	£2,213	-
RMT26/10 - 1x Section - 2600w x 1000d x 740h	£2,139	£2,569
RMT24/10 - 1x Section - 2400w x 1000d x 740h	£2,067	£2,480
RMT22/10 - 1x Section - 2200w x 1000d x 740h	£1,918	£2,302
RMT20/10 - 1x Section - 2000w x 1000d x 740h	£1,776	£2,130
RMT18/10 - 1x Section - 1800w x 1000d x 740h	£1,628	£1,954
RMT16/10 - 1x Section - 1600w x 1000d x 740h	£1,482	£1,778
RMT14/10 - 1x Section - 1400w x 1000d x 740h	£1,418	£1,701
RMT12/10 - 1x Section - 1200w x 1000d x 740h	£1,350	£1,621



RMT16/16

Reflex Square Meeting Table

- 2 week lead time. • 25mm top panel.
- Tapered angled legs with steel sub-frame. • Adjustable levelling feet.

	MFC	Veneer (3 Week Lead Time)
RMT20/20 - 2000w x 2000d x 740h	£2,014	£2,415
RMT18/18 - 1800w x 1800d x 740h	£1,868	£2,240
RMT16/16 - 1600w x 1600d x 740h	£1,719	£2,063
RMT14/14 - 1400w x 1400d x 740h	£1,572	£1,887
RMT12/12 - 1200w x 1200d x 740h	£1,426	£1,710
RMT10/10 - 1000w x 1000d x 740h	£1,279	£1,537



RMT/CIR16

Reflex Circular Meeting Table

- 2 week lead time. • 25mm top panel.
- Tapered angled legs with steel sub-frame. • Adjustable levelling feet.

	MFC	Veneer (3 Week Lead Time)
RMT/CIR20 - 2000w (dia) x 740h	£2,114	£2,536
RMT/CIR18 - 1800w (dia) x 740h	£1,963	£2,355
RMT/CIR16 - 1600w (dia) x 740h	£1,800	£2,161
RMT/CIR14 - 1400w (dia) x 740h	£1,675	£2,010
RMT/CIR12 - 1200w (dia) x 740h	£1,426	£1,710
RMT/CIR10 - 1000w (dia) x 740h	£1,311	£1,572

Conference / Meeting Reflex

Lead Time: Standard (All products are manufactured to order and when 'Standard Lead Time' is quoted (7 – 10 days), this may vary dependant on volume ordered, factory capacity and distribution requirements at the time of ordering. For more information please contact your Dealer Business Manager or the Customer Services Team for clarification.)

Metalwork: Available in Silver RAL 9006 (Standard), Black Graphite RAL 9004, White RAL 9003, Chrome Effect (Add 15%) and Raw finish (Add 5%)
Also available in Blue RAL 5001, Coral RAL 2001, Green RAL 6016, Light Grey RAL 7038, Teal RAL 5018 and Yellow RAL 1021 (Add 12% for all - 2 Week Lead Time)



LCTR16
Illustrated in red

Reflex Meeting Cable Tray

- Compatible with all Reflex conference / meeting tables.
- High capacity cable management system neatly conceals power, data and telecom cables through a hinged cable management tray.
- Cable trays are 180mm deep and 80mm high.

Metalwork

LCTO30	- For ROCT3000	- 1200w (2x)	£226
LCTO28	- For ROCT2800	- 1100w (2x)	£218
LCTO26	- For ROCT2600	- 1000w (2x)	£208
LCTO24	- For ROCT2400	- 900w (2x)	£190
LCTR48	- For 4800w Rectangular Meeting	- 900w (4x)	£382
LCTR44	- For 4400w Rectangular Meeting	- 800w (4x)	£356
LCTR40	- For 4000w Rectangular Meeting	- 1500w (2x)	£250
LCTR36	- For 3600w Rectangular Meeting	- 1300w (2x)	£234
LCTR32	- For 3200w Rectangular Meeting	- 1100w (2x)	£218
LCTR30	- For 3000w Rectangular Meeting	- 1000w (2x)	£208
LCTR28	- For 2800w Rectangular Meeting	- 1100w (2x)	£218
LCTR26	- For 2600w Rectangular Meeting	- 1000w (2x)	£208
LCTR24	- For 2400w Rectangular Meeting	- 900w (2x)	£190
LCTR22	- For 2200w Rectangular Meeting	- 800w (2x)	£178
LCTR20	- For 2000w Rectangular Meeting	- 1500w	£125
LCTR18	- For 1800w Rectangular Meeting	- 1300w	£117
LCTR16	- For 1600w Rectangular Meeting	- 1100w	£109
LCTR14	- For 1400w Rectangular Meeting	- 900w	£95
LCTR12	- For 1200w Rectangular Meeting	- 700w	£81
LCTS20	- For 2000w Square Meeting	- 1500w	£125
LCTS18	- For 1800w Square Meeting	- 1300w	£117
LCTS16	- For 1600w Square Meeting	- 1100w	£109
LCTS14	- For 1400w Square Meeting	- 900w	£95
LCTS12	- For 1200w Square Meeting	- 700w	£81
LCTS10	- For 1000w Square Meeting	- 500w	£64
LCTC18	- For 2000w and 1800w Circular Meeting	- 900w	£95
LCTC16	- For 1600w Circular Meeting	- 800w	£89
LCTC14	- For 1400w Circular Meeting	- 600w	£72
LCTC12	- For 1200w Circular Meeting	- 500w	£64



Conference / Meeting Qube

Lead Time: Standard (All products are manufactured to order and when 'Standard Lead Time' is quoted (7 – 10 days), this may vary dependant on volume ordered, factory capacity and distribution requirements at the time of ordering. For more information please contact your Dealer Business Manager or the Customer Services Team for clarification.)

Wood: Available in MFC (Ash, Autumn Cherry, Beech, Chester Oak, English Walnut, Grey, Grey Nebraska Oak, Laurentii Wenge, Natural Nebraska Oak and White)
Top Panel Edge Detail available on 25mm White MFC (Wenge and Black - Add £32 Retail Per Top) (Plywood - Add £42 Retail Per Top)
Available in Veneer (Oak and Walnut) on a 3 Week Lead Time

Metalwork: Available in Silver RAL 9006 (Standard), Black Graphite RAL 9004 and White RAL 9003



QUBR28/12

Qube Rectangular Meeting Table with Double Square Base

- 25mm top panel. • Column base finished in the same MFC as specified for table top.
- Wire managed base, 2x 80mm apertures, located within the column. • Metal corner upright.

	MFC	Veneer (3 Week Lead Time)
QUBR32/16 - 3200w x 1600d x 740h	£1,661	-
QUBR28/16 - 2800w x 1600d x 740h	£1,570	-
QUBR24/16 - 2400w x 1600d x 740h	£1,506	£1,959
QUBR32/14 - 3200w x 1400d x 740h	£1,430	-
QUBR28/14 - 2800w x 1400d x 740h	£1,353	-
QUBR24/14 - 2400w x 1400d x 740h	£1,276	£1,661
QUBR32/12 - 3200w x 1200d x 740h	£1,214	-
QUBR28/12 - 2800w x 1200d x 740h	£1,149	-
QUBR24/12 - 2400w x 1200d x 740h	£1,085	£1,410
QUBR32/10 - 3200w x 1000d x 740h	£994	-
QUBR28/10 - 2800w x 1000d x 740h	£937	-
QUBR24/10 - 2400w x 1000d x 740h	£888	£1,154



QUBR20/12

Qube Rectangular Meeting Table

- 25mm top panel. • Column base finished in the same MFC as specified for table top.
- Wire managed base, 80mm aperture, located within the column. • Metal corner upright.

	MFC	Veneer (3 Week Lead Time)
QUBR20/16 - 2000w x 1600d x 740h	£1,252	£1,627
QUBR20/14 - 2000w x 1400d x 740h	£1,137	£1,478
QUBR20/12 - 2000w x 1200d x 740h	£1,034	£1,344
QUBR20/10 - 2000w x 1000d x 740h	£905	£1,180



QUBS16/16

Qube Square Meeting Table

- 25mm top panel. • Column base finished in the same MFC as specified for table top.
- Wire managed base, 80mm aperture, located within the column. • Metal corner upright.

	MFC	Veneer (3 Week Lead Time)
QUBS16/16 - 1600w x 1600d x 740h	£829	£1,079
QUBS14/14 - 1400w x 1400d x 740h	£741	£962
QUBS12/12 - 1200w x 1200d x 740h	£586	£764
QUBS10/10 - 1000w x 1000d x 740h	£458	£598



Lead Time: 6 Weeks (Conference / Meeting)

Wood: Available in MFC (Ash, Autumn Cherry, Beech, Chester Oak, English Walnut, Grey, Grey Nebraska Oak, Laurentii Wenge, Natural Nebraska Oak and White)
Top Panel Edge Detail available on 25mm White MFC (Wenge and Black - Add £32 Retail Per Top) (Plywood - Add £42 Retail Per Top)
Available in Veneer (Oak and Walnut)

Metalwork: Available in Silver RAL 9006 (Standard) and White RAL 9003
Also available in Blue RAL 5001, Coral RAL 2001, Green RAL 6016, Light Grey RAL 7038, Teal RAL 5018 and Yellow RAL 1021 (Add 12% for all)



PCONF2

Progress Fixed Height Rectangular Conference Table

- 25mm top panel. • 6 week lead time.

PCONF2 - 3400w x 1200d x 740h
• 2x 1700mm Sections • Seating up to 10 People

PCONF1B - 2400w x 1200d x 740h
• 1x 2400mm Sections • Seating up to 8 People

PCONF1A - 2000w x 1200d x 740h
• 1x 2000mm Sections • Seating up to 8 People

MFC Veneer

£2,084 £2,605

£1,230 £1,539

£1,056 £1,321



PCONF1A



PRMT20/10

Progress Fixed Height Rectangular Meeting Table

- 25mm top panel. • 6 week lead time.

PRMT22/10 - 2200w x 1000d x 740h

PRMT20/10 - 2000w x 1000d x 740h

PRMT20/8 - 2000w x 800d x 740h

MFC Veneer

£1,092 £1,364

£1,030 £1,286

£973 £1,216



PRCT20
Illustrated in red

Progress Meeting Cable Tray

- Compatible with Progress conference and meeting tables only.
- Meeting cable trays are 100mm deep and 110mm high.

PRCT34 - For PCONF2 - Sold in 2x Sections - 2x 900w

PRCT24 - For PCONF1B - 1300w

PRCT22 - For 2200w Meeting Tables - 1100w

PRCT20 - For PCONF1A and 2000w Meeting Tables - 900w

Metalwork

£227

£147

£129

£113

Conference / Meeting Linnea

Lead Time: Standard (All products are manufactured to order and when 'Standard Lead Time' is quoted (7 – 10 days), this may vary dependant on volume ordered, factory capacity and distribution requirements at the time of ordering. For more information please contact your Dealer Business Manager or the Customer Services Team for clarification.)

Wood: Available in MFC (Ash, Autumn Cherry, Beech, Chester Oak, English Walnut, Grey, Grey Nebraska Oak, Laurentii Wenge, Natural Nebraska Oak and White) Top Panel Edge Detail available on 25mm White MFC (Wenge and Black - Add £32 Retail Per Top) (Plywood - Add £42 Retail Per Top) Available in Veneer (Oak and Walnut) on a 3 Week Lead Time

Metalwork: Available in Silver RAL 9006 (Standard), Black Graphite RAL 9004, White RAL 9003, Chrome Effect (Add 15%) and Raw finish (Add 5%) Also available in Blue RAL 5001, Coral RAL 2001, Green RAL 6016, Light Grey RAL 7038, Teal RAL 5018 and Yellow RAL 1021 (Add 12% for all - 2 Week Lead Time)



LMT16/12

Linnea Meeting Table

• 25mm top panel. • Available with 90 degree Linnea leg, suffix .../90 (see page 75).

	MFC	Veneer (3 Week Lead Time)
LMT20/16 - 2000w x 1600d x 740h	£1,061	£1,589
LMT18/16 - 1800w x 1600d x 740h	£1,012	£1,517
LMT16/16 - 1600w x 1600d x 740h	£964	£1,446
LMT20/12 - 2000w x 1200d x 740h	£958	£1,439
LMT18/12 - 1800w x 1200d x 740h	£948	£1,421
LMT16/12 - 1600w x 1200d x 740h	£932	£1,399
LMT14/12 - 1400w x 1200d x 740h	£918	£1,379
LMT12/12 - 1200w x 1200d x 740h	£905	£1,355
LMT20/10 - 2000w x 1000d x 740h	£725	£1,087
LMT18/10 - 1800w x 1000d x 740h	£708	£1,065
LMT16/10 - 1600w x 1000d x 740h	£697	£1,046
LMT14/10 - 1400w x 1000d x 740h	£688	£1,029
LMT12/10 - 1200w x 1000d x 740h	£672	£1,012
LMT10/10 - 1000w x 1000d x 740h	£663	£991
LMT20/8 - 2000w x 800d x 740h	£709	£1,066
LMT18/8 - 1800w x 800d x 740h	£699	£1,048
LMT16/8 - 1600w x 800d x 740h	£688	£1,029
LMT14/8 - 1400w x 800d x 740h	£670	£1,006
LMT12/8 - 1200w x 800d x 740h	£659	£987
LMT10/8 - 1000w x 800d x 740h	£644	£970



LMT16/12/INT

Linnea Meeting Table

• 25mm top panel. • Available with 90 degree Linnea leg, suffix .../90 (see page 75).

	MFC	Veneer (3 Week Lead Time)
LMT20/16/INT - 2000w x 1600d x 740h	£1,011	£1,540
LMT18/16/INT - 1800w x 1600d x 740h	£962	£1,468
LMT16/16/INT - 1600w x 1600d x 740h	£915	£1,397
LMT20/12/INT - 2000w x 1200d x 740h	£911	£1,391
LMT18/12/INT - 1800w x 1200d x 740h	£898	£1,372
LMT16/12/INT - 1600w x 1200d x 740h	£883	£1,350
LMT14/12/INT - 1400w x 1200d x 740h	£868	£1,329
LMT12/12/INT - 1200w x 1200d x 740h	£858	£1,307
LMT20/10/INT - 2000w x 1000d x 740h	£676	£1,037
LMT18/10/INT - 1800w x 1000d x 740h	£659	£1,015
LMT16/10/INT - 1600w x 1000d x 740h	£650	£995
LMT14/10/INT - 1400w x 1000d x 740h	£638	£979
LMT12/10/INT - 1200w x 1000d x 740h	£622	£962
LMT10/10/INT - 1000w x 1000d x 740h	£615	£942



LCONF44



LCONF24

Linnea Double 'D' Ended Conference Table

• 25mm top panel. • Available with 90 degree Linnea leg, suffix .../90 (see page 75).

	MFC	Veneer (3 Week Lead Time)
LCONF48 - 4800w x 1200d x 740h • 2x 1700mm and 1x 1400mm Sections • Seating up to 16 People	£2,937	£4,405
LCONF44 - 4400w x 1200d x 740h • 2x 2200mm Sections • Seating up to 14 People	£2,619	£3,927
LCONF34 - 3400w x 1200d x 740h • 2x 1700mm Sections • Seating up to 10 People	£2,215	£3,325
LCONF24 - 2400w x 1200d x 740h • 1x 2400mm Section • Seating up to 8 People	£1,542	£2,315
LCONF20 - 2000w x 1200d x 740h • 1x 2000mm Section • Seating up to 6 People	£1,276	£1,914

Conference / Meeting Linnea

Lead Time: Standard (All products are manufactured to order and when 'Standard Lead Time' is quoted (7 – 10 days), this may vary dependant on volume ordered, factory capacity and distribution requirements at the time of ordering. For more information please contact your Dealer Business Manager or the Customer Services Team for clarification.)

Metalwork: Available in Silver RAL 9006 (Standard), Black Graphite RAL 9004, White RAL 9003, Chrome Effect (Add 15%) and Raw finish (Add 5%)
Also available in Blue RAL 5001, Coral RAL 2001, Green RAL 6016, Light Grey RAL 7038, Teal RAL 5018 and Yellow RAL 1021 (Add 12% for all - 2 Week Lead Time)



LINCTC24
Illustrated in red

Linnea Conference / Meeting Cable Tray

- Tray can be positioned to the users side of the workstation or towards the middle.
- Cable trays are 100mm deep and 110mm high.

						Metalwork
LINCTC48	- For LCONF48	- 1030w (3x)	_____			£333
LINCTC44	- For LCONF44	- 1630w (2x)	_____			£326
LINCTC34	- For LCONF34	- 1030w (2x)	_____			£222
LINCTC24	- For LCONF24	- 1430w	_____			£148
LINCTC20	- For LCONF20	- 1030w	_____			£111
LINCTM20	- For 2000w and 1600d, 1200d and 1000d Meeting Tables	- 1630w	_____			£163
LINCTM18	- For 1800w and 1600d, 1200d and 1000d Meeting Tables	- 1430w	_____			£148
LINCTM16	- For 1600w and 1600d, 1200d and 1000d Meeting Tables	- 1230w	_____			£129
LINCTM14	- For 1400w and 1600d, 1200d and 1000d Meeting Tables	- 1030w	_____			£111
LINCTM12	- For 1200w and 1600d, 1200d and 1000d Meeting Tables	- 830w	_____			£100
LINCTM10	- For 1000w and 1600d, 1200d and 1000d Meeting Tables	- 630w	_____			£85



LRCT16
Illustrated in red

Linnea Meeting Cable Tray

- Cable trays can be accessed from the front or back of the desk via the easy slot and hook design.
- Cable trays are 222mm deep and 56mm high.
- Cable trays will only accept 2 gang sockets such as **SK2/S** (see page 319).

						Metalwork
LRCT20	- For 2000w and 800d Meeting Tables	- 1470w	_____			£163
LRCT18	- For 1800w and 800d Meeting Tables	- 1270w	_____			£148
LRCT16	- For 1600w and 800d Meeting Tables	- 1070w	_____			£129
LRCT14	- For 1400w and 800d Meeting Tables	- 870w	_____			£111
LRCT12	- For 1200w and 800d Meeting Tables	- 670w	_____			£100
LRCT10	- For 1000w and 800d Meeting Tables	- 470w	_____			£85



Conference / Meeting Matrix

Lead Time: Standard (All products are manufactured to order and when 'Standard Lead Time' is quoted (7 – 10 days), this may vary dependant on volume ordered, factory capacity and distribution requirements at the time of ordering. For more information please contact your Dealer Business Manager or the Customer Services Team for clarification.)

Wood: Available in MFC (Ash, Autumn Cherry, Beech, Chester Oak, English Walnut, Grey, Grey Nebraska Oak, Laurentii Wenge, Natural Nebraska Oak and White)
Top Panel Edge Detail available on 25mm White MFC (Wenge and Black - Add £32 Retail Per Top) (Plywood - Add £42 Retail Per Top)

Metalwork: Available in Silver RAL 9006 (Standard), Black Graphite RAL 9004, White RAL 9003, Chrome Effect (Add 15%) and Raw finish (Add 5%)
Also available in Blue RAL 5001, Coral RAL 2001, Green RAL 6016, Light Grey RAL 7038, Teal RAL 5018 and Yellow RAL 1021 (Add 12% for all - 2 Week Lead Time)



AMT16/10

Matrix Height Settable Meeting Table

- 25mm top panel.
- Sit / sit height adjustment of 650mm-850mm via single leg fixing.

Model	Dimensions	Price
AMT20/10	2000w x 1000d x 650-850h	£725
AMT18/10	1800w x 1000d x 650-850h	£708
AMT16/10	1600w x 1000d x 650-850h	£697
AMT14/10	1400w x 1000d x 650-850h	£688
AMT12/10	1200w x 1000d x 650-850h	£672
AMT10/10	1000w x 1000d x 650-850h	£663
AMT20/8	2000w x 800d x 650-850h	£709
AMT18/8	1800w x 800d x 650-850h	£699
AMT16/8	1600w x 800d x 650-850h	£688
AMT14/8	1400w x 800d x 650-850h	£670
AMT12/8	1200w x 800d x 650-850h	£659
AMT10/8	1000w x 800d x 650-850h	£644



MCONF34

Matrix Fixed Height Rectangular Conference Table

- 25mm top panel.

Model	Dimensions	Price
MCONF34	3400w x 1200d x 740h	£1,630



MMT16/12

Matrix Fixed Height Meeting Table

- 25mm top panel.

Model	Dimensions	Price
MMT20/16	2000w x 1600d x 740h	£845
MMT18/16	1800w x 1600d x 740h	£829
MMT16/16	1600w x 1600d x 740h	£816
MMT20/14	2000w x 1400d x 740h	£827
MMT18/14	1800w x 1400d x 740h	£811
MMT16/14	1600w x 1400d x 740h	£799
MMT14/14	1400w x 1400d x 740h	£791
MMT20/12	2000w x 1200d x 740h	£808
MMT18/12	1800w x 1200d x 740h	£794
MMT16/12	1600w x 1200d x 740h	£779
MMT14/12	1400w x 1200d x 740h	£771
MMT12/12	1200w x 1200d x 740h	£765
MMT20/10	2000w x 1000d x 740h	£579
MMT18/10	1800w x 1000d x 740h	£573
MMT16/10	1600w x 1000d x 740h	£566
MMT14/10	1400w x 1000d x 740h	£561
MMT12/10	1200w x 1000d x 740h	£554
MMT10/10	1000w x 1000d x 740h	£546
MMT20/8	2000w x 800d x 740h	£557
MMT18/8	1800w x 800d x 740h	£546
MMT16/8	1600w x 800d x 740h	£540
MMT14/8	1400w x 800d x 740h	£532
MMT12/8	1200w x 800d x 740h	£526
MMT10/8	1000w x 800d x 740h	£518



MA7D
Illustrated in red

Matrix Conference / Meeting Cable Tray

- High capacity cable management system neatly conceals power, data and telecom cables through a hinged cable management tray.
- Cable trays are 222mm deep and 92mm high.

Model	Dimensions	Price
MA8D	For MCONF34 - 1400w	£126
MA10D	For 2000w and 1600, 1400 and 1200d Meeting Tables - 1700w	£151
MA9D	For 1800w and 1600, 1400 and 1200d Meeting Tables - 1500w	£133
MA7D	For 1600w and 1600, 1400 and 1200d Meeting Tables - 1300w	£119
MA5D	For 1400w and 1600, 1400 and 1200d Meeting Tables - 1100w	£101
MA3D	For 1200w and 1600, 1400 and 1200d Meeting Tables - 900w	£92
MA2D	For 1000w and 1600, 1400 and 1200d Meeting Tables - 700w	£76

Conference / Meeting Optima Plus

Lead Time: Standard (All products are manufactured to order and when 'Standard Lead Time' is quoted (7 – 10 days), this may vary dependant on volume ordered, factory capacity and distribution requirements at the time of ordering. For more information please contact your Dealer Business Manager or the Customer Services Team for clarification.)

Wood: Available in MFC (Ash, Autumn Cherry, Beech, Chester Oak, English Walnut, Grey, Grey Nebraska Oak, Laurentii Wenge, Natural Nebraska Oak and White) Top Panel Edge Detail available on 25mm White MFC (Wenge and Black - Add £32 Retail Per Top) (Plywood - Add £42 Retail Per Top) Available in Veneer (Oak and Walnut) on a 3 Week Lead Time

Metalwork: Available in Silver RAL 9006 (Standard), Black Graphite RAL 9004, White RAL 9003 and Chrome Effect (Add 15%) Also available in Blue RAL 5001, Coral RAL 2001, Green RAL 6016, Light Grey RAL 7038, Teal RAL 5018 and Yellow RAL 1021 (Add 12% for all - 2 Week Lead Time)



OPCONF2

Optima Plus Double 'D' Ended Conference Table

• 25mm top panel. • 'I' frame leg configuration with modesty panel.

OPCONF3 - 4800w x 1200d x 740h
• 2x 1700mm and 1x 1400mm Sections • Seating up to 14 People

OPCONF2 - 3400w x 1200d x 740h
• 2x 1700mm Sections • Seating up to 10 People

OPCONF1B - 2400w x 1200d x 740h
• 1x 2400mm Section • Seating up to 8 People

OPCONF1A - 2000w x 1200d x 740h
• 1x 2000mm Section • Seating up to 8 People

MFC
Veneer (3 Week Lead Time)

£2,643 £4,099

£2,068 £3,207

£1,239 £1,925

£1,034 £1,602



OPCONF1A

Optima Plus Double 'D' Ended Conference Table

• 25mm top panel. • 120mm diameter legs on 685mm diameter bases.

OPCONF1CB - 2400w x 1200d x 725h
• 1x 2400mm Section • Seating up to 8 People

OPCONF1CA - 2000w x 1200d x 725h
• 1x 2000mm Section • Seating up to 8 People

MFC
Veneer (3 Week Lead Time)

£1,239 £1,925

£1,034 £1,602



OPCONF1CA

Optima Plus Rectangular Conference Table

• 25mm top panel. • Supplied with MT01 bases.
• Wire managed base, 80mm aperture, located within the column. • 100mm square column.
• Heavy duty weighted 505mm square x 15mm deep base. • Levelling feet.

OPCONF1SB - 2400w x 1200d x 740h
• 1x 2400mm Section • Seating up to 8 People

OPCONF1SA - 2000w x 1200d x 740h
• 1x 2000mm Section • Seating up to 8 People

MFC
Veneer (3 Week Lead Time)

£1,239 £1,925

£1,034 £1,602



OPCONF1SA

Optima Plus Double 'D' Ended Meeting Table

• 25mm top panel. • 'I' frame leg configuration with modesty panel.

OPDDMT26 - 2600w x 800d x 740h

OPDDMT24 - 2400w x 800d x 740h

OPDDMT22 - 2200w x 800d x 740h

OPDDMT20 - 2000w x 800d x 740h

MFC
Veneer (3 Week Lead Time)

£906 -

£886 £1,280

£872 £1,262

£851 £1,233



OPDDMT24

Optima Plus 'D' Ended Meeting Table

• 25mm top panel. • 'I' frame leg configuration with modesty panel.

OPDMT22 - 2200w x 800d x 740h

OPDMT20 - 2000w x 800d x 740h

OPDMT18 - 1800w x 800d x 740h

OPDMT16 - 1600w x 800d x 740h

MFC
Veneer (3 Week Lead Time)

£828 £1,196

£809 £1,177

£794 £1,146

£776 £1,124



OPDMT20

Optima Plus Rectangular Meeting Table

• 25mm top panel. • 'I' frame leg configuration with modesty panel.

OPRMT18 - 1800w x 800d x 740h

OPRMT16 - 1600w x 800d x 740h

OPRMT14 - 1400w x 800d x 740h

OPRMT12 - 1200w x 800d x 740h

MFC
Veneer (3 Week Lead Time)

£626 £906

£607 £881

£593 £858

£572 £831



OPRMT16

Conference / Meeting Callisto and Windsor

Lead Time: Standard (All products are manufactured to order and when 'Standard Lead Time' is quoted (7 – 10 days), this may vary dependant on volume ordered, factory capacity and distribution requirements at the time of ordering. For more information please contact your Dealer Business Manager or the Customer Services Team for clarification.)

Wood: Available in MFC (Ash, Autumn Cherry, Beech, Chester Oak, English Walnut, Grey, Grey Nebraska Oak, Laurentii Wenge, Natural Nebraska Oak and White)
Top Panel Edge Detail available on 25mm White MFC (Wenge and Black - Add £32 Retail Per Top) (Plywood - Add £42 Retail Per Top)
Available in Veneer (Oak and Walnut) on a 3 Week Lead Time

Metalwork: **Callisto:** Available in Silver RAL 9006 (Standard), Black Graphite RAL 9004, White RAL 9003 and Chrome Effect (Add 15%)
Also available in Blue RAL 5001, Coral RAL 2001, Green RAL 6016, Light Grey RAL 7038, Teal RAL 5018 and Yellow RAL 1021 (Add 12% for all - 2 Week Lead Time)
Windsor: Available in Silver RAL 9006 (Standard), Black Graphite RAL 9004 and White RAL 9003



CSCT

Callisto Segué Conference Table

• 25mm top panel. • 'A' frame style leg configuration. • Optional infill panel.

CSCT - 4830w (extreme) x 2470d (extreme) x 740h
• 6x Curved Sections and 2x Curved Corner Sections • Seating up to 16 People

CSCTI - Infill Panel Only

MFC
Veneer (3 Week Lead Time)

£3,927 £5,679

£629 £907



CSMT

Callisto Segué Meeting Table

• 25mm top panel. • 'A' frame style leg configuration. • Optional infill panel.

CSMT - 2830w (extreme) x 2755d (extreme) x 740h
• 3x Curved Sections and 3x Curved Corner Sections • Seating up to 12 People

CSMTI - Infill Panel Only

MFC
Veneer (3 Week Lead Time)

£3,517 £5,091

£514 £749



COCT24

Callisto Oval Conference Table

• 25mm top panel. • 'A' frame style leg configuration.

COCT24 - 2400w x 1200d x 740h
• 1x 2400mm Section • Seating up to 8 People

MFC
Veneer (3 Week Lead Time)

£1,466 £2,124



CONF2AL

Windsor Double 'D' Ended Conference Table

• 25mm top panel. • Arrowhead leg configuration with modesty panel.

CONF2AL - 3400w x 1200d x 740h
• 2x 1700mm Sections • Seating up to 10 People

DDT24 - 2400w x 1200d x 740h
• 1x 2400mm Section • Seating up to 8 People

MFC
Veneer (3 Week Lead Time)

£2,180 £3,384

£1,531 £2,372



DDT24



OVT24

Windsor Oval Conference Table

• 25mm top panel. • Arrowhead leg configuration with modesty panel.

OVT24 - 2400w x 1200d x 740h
• 1x 2400mm Section • Seating up to 8 People

MFC
Veneer (3 Week Lead Time)

£1,531 £2,372



BST24

Windsor Barrel Conference Table

• 25mm top panel. • Arrowhead leg configuration with modesty panel.

BST24 - 2400w x 1200d x 740h
• 1x 2400mm Section • Seating up to 8 People

MFC
Veneer (3 Week Lead Time)

£1,531 £2,372

Conference / Meeting Flare Boardroom Storage Units

Lead Time: Standard (All products are manufactured to order and when 'Standard Lead Time' is quoted (7 – 10 days), this may vary dependant on volume ordered, factory capacity and distribution requirements at the time of ordering. For more information please contact your Dealer Business Manager or the Customer Services Team for clarification.)

Wood: Available in MFC (Ash, Autumn Cherry, Beech, Chester Oak, English Walnut, Grey, Grey Nebraska Oak, Laurentii Wenge, Natural Nebraska Oak and White)
Top Panel Edge Detail available on 25mm White MFC (Wenge and Black - Add £30 Retail Per Top) (Plywood - Add £40 Retail Per Top)
Available in Nanotech (Black)
Available in Veneer (Oak and Walnut) on a 3 Week Lead Time
Specific items also available in Coloured MFC (Paraline, Petrol, Red, Sea Blue, Turquoise and Yellow)

Metalwork: Available in the finishes detailed below

Flare Boardroom Storage Unit

- 25mm top panel.
- 2 / 3 / 4x hinged doors.
- Lockable, includes 2x keys.
- All units supplied with 1 piece top and bottom.
- Contrasting doors available on MFC and Black Nanotech only.
- Alternative handles available (see page 234-235).
- Additional shelves available (see page 186).



FLA7/5/D4



FLA7/5/D3



FLA7/5/D2

				MFC	Black Nanotech	Veneer (3 Week Lead Time)
FLA7/6/D4...	- 4 Doors	- 2x Adjustable Shelves	- 2000w x 600d x 740h	£1,277	£1,819	£1,885
FLA7/5/D4...	- 4 Doors	- 2x Adjustable Shelves	- 2000w x 500d x 740h	£1,199	£1,674	£1,760
FLA7/6/D3...	- 3 Doors	- 2x Adjustable Shelves	- 1500w x 600d x 740h	£1,024	£1,429	£1,490
FLA7/5/D3...	- 3 Doors	- 2x Adjustable Shelves	- 1500w x 500d x 740h	£962	£1,324	£1,393
FLA7/6/D2...	- 2 Doors	- 1x Adjustable Shelf	- 1000w x 600d x 740h	£739	£1,038	£1,049
FLA7/5/D2...	- 2 Doors	- 1x Adjustable Shelf	- 1000w x 500d x 740h	£699	£966	£986

- Silver (.../SF) as Standard
- Add £0 for Black Graphite (.../BGF) or White (.../WF)
- Add £20 for Raw Metalwork (.../RF)
- Add £48 for Black (.../BF), Blue (.../BUF), Coral (.../CRF), Green (.../GNF), Light Grey (.../LGF), Teal (.../TLF) or Yellow (.../YEF)
- Add £69 for Chrome Effect (.../CF)
- Add £0 (on MFC) or £0 (on Black Nanotech) per door for Standard MFC Contrasting Door Finish (.../CON)
- Add £24 (on MFC) or £0 (on Black Nanotech) per door for Coloured MFC Contrasting Door Finish (.../CON)
- Add £27 (on MFC) or £0 (on Black Nanotech) per door for Black Nanotech Contrasting Door Finish (.../CON)
Further information required, contact Customer Services for a specification form.
- For Fridge Cut-Out on 600d only, add £90 per Cut-Out and suffix FDG codes (see page 239)



Conference / Meeting Combined Storage Units

Lead Time: Standard (All products are manufactured to order and when 'Standard Lead Time' is quoted (7 – 10 days), this may vary dependant on volume ordered, factory capacity and distribution requirements at the time of ordering. For more information please contact your Dealer Business Manager or the Customer Services Team for clarification.)

Wood: Available in MFC (Ash, Autumn Cherry, Beech, Chester Oak, English Walnut, Grey, Grey Nebraska Oak, Laurentii Wenge, Natural Nebraska Oak and White)
Top Panel Edge Detail available on 25mm White MFC (Wenge and Black - Add £32 Retail Per Top) (Plywood - Add £42 Retail Per Top)
Available in Nanotech (Black)
Available in Veneer (Oak and Walnut) on a 3 Week Lead Time
Specific items also available in Coloured MFC (Paraline, Petrol, Red, Sea Blue, Turquoise and Yellow)

Combined Storage Unit

- 25mm top panel. • 2/3/4x hinged doors. • Lockable, includes 2x keys.
- 1000w and 1500w units supplied with 1 piece top and bottom.
- 2000w units supplied with 1 piece top and 2 piece bottom.
- Contrasting doors available on MFC and Black Nanotech only.
- Alternative handles available (see page 234-235).
- Additional shelves available (see below).



CSU7/5/D4



CSU7/5/D3



CSU7/5/D2

	MFC	Black Nanotech	Veneer (3 Week Lead Time)
CSU7/6/D4 - 4 Doors - 2x Adjustable Shelves - 2000w x 600d x 740h	£1,106	£1,647	£1,712
CSU7/5/D4 - 4 Doors - 2x Adjustable Shelves - 2000w x 500d x 740h	£1,027	£1,502	£1,588
CSU7/6/D3 - 3 Doors - 2x Adjustable Shelves - 1500w x 600d x 740h	£851	£1,257	£1,318
CSU7/5/D3 - 3 Doors - 2x Adjustable Shelves - 1500w x 500d x 740h	£791	£1,152	£1,221
CSU7/6/D2 - 2 Doors - 1x Adjustable Shelf - 1000w x 600d x 740h	£567	£866	£878
CSU7/5/D2 - 2 Doors - 1x Adjustable Shelf - 1000w x 500d x 740h	£527	£793	£813

- Add £0 (on MFC) or £0 (on Black Nanotech) per door for Standard MFC Contrasting Door Finish (.../CON)
 - Add £24 (on MFC) or £0 (on Black Nanotech) per door for Coloured MFC Contrasting Door Finish (.../CON)
 - Add £27 (on MFC) or £0 (on Black Nanotech) per door for Nanotech MDF Contrasting Door Finish (.../CON)
- Further information required, contact Customer Services for a specification form.

- For Fridge Cut-Out on 600d only, add £90 per Cut-Out and suffix FDG codes below

Flare Boardroom and Combined Storage Unit Cut-Out for Fridge

- Applies a cut-out to the chosen back section of the 600d unit only and extra panels are added to divide the remaining internal space.
- To apply a fridge cut-out to the 600d Flare Boardroom and Combined Storage Units, suffix .../FDG to your chosen unit and refer to the '123' guide below. • Section numbers always start from left-hand section.

	Price
.../FDG1 - Cut-Out in Section 1 on 2, 3 and 4 Door Units	£90
.../FDG2 - Cut-Out in Section 2 on 2, 3 and 4 Door Units	£90
.../FDG3 - Cut-Out in Section 3 on 4 Door Units	£90
.../FDG4 - Cut-Out in Section 4 on 4 Door Units	£90



- 1 Section 1
- 2 Section 2
- 3 Section 3
- 4 Section 4

Flare Boardroom and Combined Storage Unit Adjustable Shelves



CSU/5/S/D2

	MFC	Black Nanotech	Veneer (3 Week Lead Time)
CSU/5/S/D1 - For Single Section 3 Door 500d Units - 472w x 408d x 18h	£22	£32	£34
CSU/5/S/D2 - For 2 / 4 Door 500d Units - 963w x 408d x 18h	£41	£61	£67
CSU/5/S/D3 - For Double Section 3 Door 500d Units - 972w x 408d x 18h	£41	£61	£67
CSU/6/S/D1 - For Single Section 3 Door 600d Units - 472w x 508d x 18h	£24	£34	£36
CSU/6/S/D2 - For 2 / 4 Door 600d Units - 963w x 508d x 18h	£48	£67	£71
CSU/6/S/D3 - For Double Section 3 Door 600d Units - 972w x 508d x 18h	£48	£67	£71

Modular Meeting Mobile Whiteboard Unit

Lead Time: Standard (All products are manufactured to order and when 'Standard Lead Time' is quoted (7 – 10 days), this may vary dependant on volume ordered, factory capacity and distribution requirements at the time of ordering. For more information please contact your Dealer Business Manager or the Customer Services Team for clarification.)

Metalwork: Available in Silver RAL 9006 (Standard), Black Graphite RAL 9004 and White RAL 9003
Also available in Blue RAL 5001, Coral RAL 2001, Green RAL 6016, Light Grey RAL 7038, Teal RAL 5018 and Yellow RAL 1021 (Add 12% for all - 2 Week Lead Time)



MWBP

Mobile Portrait Whiteboard Unit

- 25mm top panel. • Mobile drywipe whiteboard.
- Portrait (900w x 1200h) or landscape (1200w x 900h) options.
- 360 degree rotation. • Magnetic. • Storage tray. • 2x locking castors.

Price

MWBP - 1000w x 620d x 1850h

£785



MWBL

Mobile Landscape Whiteboard Unit

- 25mm top panel. • Mobile drywipe whiteboard.
- Portrait (900w x 1200h) or landscape (1200w x 900h) options.
- 360 degree rotation. • Magnetic. • Storage tray. • 2x locking castors.

Price

MWBL - 1300w x 620d x 1700h

£813



Conference / Meeting Power Modules

Lead Time: Standard (All products are manufactured to order and when 'Standard Lead Time' is quoted (7 – 10 days), this may vary dependant on volume ordered, factory capacity and distribution requirements at the time of ordering. For more information please contact your Dealer Business Manager or the Customer Services Team for clarification.)

Finish: Kaspia: Available with Silver Body with Black Inserts, Black Body with Black Inserts and Matt White Body with Black Inserts

Finish: Prime: Available with Silver Body with Black Inserts, Black Body with Black Inserts and Matt White Body with Black Inserts

Guarantee: 1 Year Guarantee on All Electrical Items



POW/KAS/1P1T/S

Kaspa Power and Media Module

- 1x or 2x 3.15 amp individually fused sockets.
- 1x USB twin charger (type A+A).
- Integral colour coded fuse clips.
- 200mm power and connection lead to 3 pole connector.
- Fixing via 135w x 53d (1 gang) or 189w x 53d (2 gang) aperture.
- Requires a separate mains lead if connecting directly into a socket (see page 195).

									Price
POW/KAS/1P1T/S	- 1x Power, 1x USB Twin Charger	- Silver	- 151w x 70d						£197
POW/KAS/1P1T/B	- 1x Power, 1x USB Twin Charger	- Black	- 151w x 70d						£197
POW/KAS/1P1T/W	- 1x Power, 1x USB Twin Charger	- White	- 151w x 70d						£197
POW/KAS/2P1T/S	- 2x Power, 1x USB Twin Charger	- Silver	- 204w x 70d						£220
POW/KAS/2P1T/B	- 2x Power, 1x USB Twin Charger	- Black	- 204w x 70d						£220
POW/KAS/2P1T/W	- 2x Power, 1x USB Twin Charger	- White	- 204w x 70d						£220



POW/KAS/1P1T/S
Silver Body with Black Inserts



POW/KAS/1P1T/B
Black Body with Black Inserts



POW/KAS/1P1T/W
Matt White Body with Black Inserts



POW/PRI/2P1T/S
Showing 3x Power Version

Prime Power and Media Module

- 2x 3.15 amp individually fused sockets.
- 1x USB twin charger (type A+A).
- 200mm power and connection lead to 3 pole connector.
- Fixing via 225w x 60d aperture.
- Requires a separate mains lead if connecting directly into a socket (see page 195).

									Price
POW/PRI/2P1T/S	- 2x Power, 1x USB Twin Charger	- Without Cover	- Silver	- 241w x 73d	-				£235
POW/PRI/2P1T/B	- 2x Power, 1x USB Twin Charger	- Without Cover	- Black	- 241w x 73d	-				£235
POW/PRI/2P1T/W	- 2x Power, 1x USB Twin Charger	- Without Cover	- White	- 241w x 73d	-				£235



POW/PRI/2P1T/S
Silver Body with Black Inserts



POW/PRI/2P1T/B
Black Body with Black Inserts



POW/PRI/2P1T/W
Matt White Body with Black Inserts



POW/PRI/2P1T/C/S

Prime Power and Media Module With Cover

- 2x 3.15 amp individually fused sockets.
- 1x USB twin charger (type A+A).
- 200mm power and connection lead to 3 pole connector.
- Fixing via 225w x 60d aperture.
- Casing provided to discretely protect cables and sockets.
- Requires a separate mains lead if connecting directly into a socket (see page 195).

									Price
POW/PRI/2P1T/C/S	- 2x Power, 1x USB Twin Charger	- With Cover	- Silver	- 257w x 88d	-				£333
POW/PRI/2P1T/C/B	- 2x Power, 1x USB Twin Charger	- With Cover	- Black	- 257w x 88d	-				£333
POW/PRI/2P1T/C/W	- 2x Power, 1x USB Twin Charger	- With Cover	- White	- 257w x 88d	-				£333



POW/PRI/2P1T/C/S
Silver Body with Black Inserts



POW/PRI/2P1T/C/B
Black Body with Black Inserts



POW/PRI/2P1T/C/W
Matt White Body with Black Inserts

Lead Time: 3 Weeks (Black with Black Trim and White with Grey Trim) and Standard (Silver with Grey Trim) (All products are manufactured to order and when 'Standard Lead Time' is quoted (7 – 10 days), this may vary dependant on volume ordered, factory capacity and distribution requirements at the time of ordering. For more information please contact your Dealer Business Manager or the Customer Services Team for clarification.)

Finish: **Boardroom:** Available with Silver Body with Grey Trim, Black Body with Black Trim (3 Week Lead Time) and White Body with Grey Trim (3 Week Lead Time)

Guarantee: 1 Year Guarantee on All Electrical Items



PPM2/S



PPM4/S

Boardroom Power Module

- 3 week lead time on black with black trim and white with grey trim power modules.
- 2x or 4x 3.15 amp individually fused sockets.
- Fixing via 272w x 132d (2 gang) or 430w x 132d (4 gang) aperture.
- Requires a separate mains lead if connecting directly into a socket (see page 195).

									Price
PPM2/S	- 2x Power	- Grey	- 300w x 150d						£298
PPM2/B	- 2x Power	- Black	- 300w x 150d	- 3 Week Lead Time					£385
PPM2/W	- 2x Power	- White	- 300w x 150d	- 3 Week Lead Time					£385
PPM4/S	- 4x Power	- Grey	- 460w x 150d						£413
PPM4/B	- 4x Power	- Black	- 460w x 150d	- 3 Week Lead Time					£534
PPM4/W	- 4x Power	- White	- 460w x 150d	- 3 Week Lead Time					£534



PPMD2/S



PPMD4/S

Boardroom Power and Data Module

- 3 week lead time on black with black trim and white with grey trim power modules.
- 2x or 4x 3.15 amp individually fused sockets.
- 2x Cat5e data sockets, includes 3 metre data cable.
- Fixing via 272w x 132d (2 gang) or 430w x 132d (4 gang) aperture.
- Requires a separate mains lead if connecting directly into a socket (see page 195).

									Price
PPMD2/S	- 2x Power, Data	- Grey	- 300w x 150d						£391
PPMD2/B	- 2x Power, Data	- Black	- 300w x 150d	- 3 Week Lead Time					£473
PPMD2/W	- 2x Power, Data	- White	- 300w x 150d	- 3 Week Lead Time					£473
PPMD4/S	- 4x Power, Data	- Grey	- 460w x 150d						£500
PPMD4/B	- 4x Power, Data	- Black	- 460w x 150d	- 3 Week Lead Time					£618
PPMD4/W	- 4x Power, Data	- White	- 460w x 150d	- 3 Week Lead Time					£618



PPMMD2/S



PPMMD4/S

Boardroom Power, Media and Data Module

- 3 week lead time on black with black trim and white with grey trim power modules.
- 2x or 4x 3.15 amp individually fused sockets. • 1x USB twin charger (type A+C).
- 1x VGA and 1x 3.5mm stereo. • 1x HDMI-1.3. • 1x Cat5e data socket.
- Includes ratchet clips and earthing kit.
- Fixing via 272w x 132d (2 gang) or 430w x 132d (4 gang) aperture.
- Requires a separate mains lead if connecting directly into a socket (see page 195).

									Price
PPMMD2/S	- 2x Power, Media, Data	- Grey	- 300w x 150d						£1,020
PPMMD2/B	- 2x Power, Media, Data	- Black	- 300w x 150d	- 3 Week Lead Time					£1,091
PPMMD2/W	- 2x Power, Media, Data	- White	- 300w x 150d	- 3 Week Lead Time					£1,091
PPMMD4/S	- 4x Power, Media, Data	- Grey	- 460w x 150d						£1,126
PPMMD4/B	- 4x Power, Media, Data	- Black	- 460w x 150d	- 3 Week Lead Time					£1,233
PPMMD4/W	- 4x Power, Media, Data	- White	- 460w x 150d	- 3 Week Lead Time					£1,233



PPM2/S
Silver Body with Grey Trim



PPM2/B
Black Body with Black Trim
(3 Week Lead Time)



PPM2/W
White Body with Grey Trim
(3 Week Lead Time)

Lead Time: Standard (All products are manufactured to order and when 'Standard Lead Time' is quoted (7 – 10 days), this may vary dependant on volume ordered, factory capacity and distribution requirements at the time of ordering. For more information please contact your Dealer Business Manager or the Customer Services Team for clarification.)

Finish: Conus: Available with Silver Body with Black Inserts, Black Body with Black Inserts and Matt White Body with Black Inserts (All with a 3 Week Lead Time)

Guarantee: 1 Year Guarantee on All Electrical Items



POW/CON/2P1D/S...

Conus Boardroom Power Module

- 2x or 4x 3.15 amp individually fused sockets.
- 1x or 2x various additional data options (HDMI (.../OP1), VGA / Jack (.../OP2), USB twin charger (.../OP3), 2x CAT6A (.../OP4) and Blank Front (.../OP5).
- Suffix 1x data option onto 2 Gang versions (e.g. POW/CON/2P1D/S/OP2) and 2x data options onto 4 Gang versions (e.g. POW/CON/4P2D/S/OP1/OP3).
- 200mm power and connection lead to 3 pole connector.
- Fixing via 230w x 138d (2 gang) or 369w x 138d (4 gang) aperture.
- Requires a separate mains lead if connecting directly into a socket (see page 195).

									Price
POW/CON/2P1D/S...	- 2x Power, 1x Data Option	- Silver	- 255w x 151d						£295
POW/CON/2P1D/B...	- 2x Power, 1x Data Option	- Black	- 255w x 151d						£295
POW/CON/2P1D/W...	- 2x Power, 1x Data Option	- White	- 255w x 151d						£295
POW/CON/4P2D/S...	- 4x Power, 2x Data Option	- Silver	- 387w x 151d						£366
POW/CON/4P2D/B...	- 4x Power, 2x Data Option	- Black	- 387w x 151d						£366
POW/CON/4P2D/W...	- 4x Power, 2x Data Option	- White	- 387w x 151d						£366



POW/CON/2P1D/S
Silver Body with Black Inserts



POW/CON/2P1D/B
Black Body with Black Inserts



POW/CON/2P1D/W
Matt White Body with Black Inserts



.../OP2



.../OP3



.../OP5

Conus Data Options

- Suffix 1x data option onto 2 Gang versions (e.g. POW/CON/2P1D/S/OP2) and 2x data options onto 4 Gang versions (e.g. POW/CON/4P2D/S/OP1/OP3).
- HDMI (.../OP1). • VGA / Jack (.../OP2). • USB Twin Charger (.../OP3).
- 2x CAT6A (.../OP4). • Blank Front (.../OP5).

									Price
.../OP1	- HDMI with 3m Tails								£94
.../OP2	- VGA / Jack with 3m Tails								£124
.../OP3	- USB Twin Charger (Type A+C)								£96
.../OP4	- 2x CAT6A with 3m Tails								£104
.../OP5	- Blank Front								£4



Lead Time: 3 Weeks (Peak) or Standard (Escalate) (All products are manufactured to order and when 'Standard Lead Time' is quoted (7 - 10 days), this may vary dependant on volume ordered, factory capacity and distribution requirements at the time of ordering. For more information please contact your Dealer Business Manager or the Customer Services Team for clarification.)

Finish: Peak: Available with Stainless Steel Silver Body with Black Inserts, Black Body with Black Inserts and Matt White Body with Grey Inserts (All with a 3 Week Lead Time)

Finish: Escalate: Available with Silver Body

Guarantee: 1 Year Guarantee on All Electrical Items



PEAPM60/S



PEAPM80/W



PEAPM60/S
Stainless Steel Silver Body with Black Inserts



PEAPM80/B
Black Body with Black Inserts



PEAPM80/W
Matt White Body with Grey Inserts

Peak Power and Media Module

- 3 week lead time.
- 4x or 6x 3.15 amp individually fused sockets.
- 2x USB twin chargers (type A+C).
- Integral colour coded fuse clips.
- Hardwired 800mm lead to GST18/3 male/b.
- Includes 4x screw clamps.
- Fixing via 194w x 134d (4 gang) or 274w x 134d (6 gang) aperture.
- Requires a separate mains lead if connecting directly into a socket (see page 195).

PEAPM60/S	- 4x Power, 2x USB Twin Charger	- Silver	- 220w x 155d	_____	£797
PEAPM60/B	- 4x Power, 2x USB Twin Charger	- Black	- 220w x 155d	_____	£826
PEAPM60/W	- 4x Power, 2x USB Twin Charger	- White	- 220w x 155d	_____	£826

PEAPM80/S	- 6x Power, 2x USB Twin Charger	- Silver	- 300w x 155d	_____	£851
PEAPM80/B	- 6x Power, 2x USB Twin Charger	- Black	- 300w x 155d	_____	£885
PEAPM80/W	- 6x Power, 2x USB Twin Charger	- White	- 300w x 155d	_____	£885

Price



Escalate Power and Media Module

- 1x 3.15 amp individually fused socket.
- 1x USB twin charger (type A+A).
- 500mm power and connection lead to 3 pole connector.
- Fixing via 80w porthole aperture.
- Requires a separate mains lead if connecting directly into a socket (see page 195).

POW/ESC/1P1T/S	- 1x Power, 1x USB Twin Charger	- Silver	- 95w (dia) x 230h	_____	£202
-----------------------	---------------------------------	----------	--------------------	-------	------

Price



POW/ESC/1P1T/S



POW/ESC/1P1T/S

Conference / Meeting Power Modules

Lead Time: Standard (All products are manufactured to order and when 'Standard Lead Time' is quoted (7 – 10 days), this may vary dependant on volume ordered, factory capacity and distribution requirements at the time of ordering. For more information please contact your Dealer Business Manager or the Customer Services Team for clarification.)

Finish: **Wireless Charging Unit:** Available with Black Body and Trim, Black Body and Aluminium Trim, White Body and Trim and White Body and Aluminium Trim

Guarantee: 1 Year Guarantee on All Electrical Items



WCU/BB

Wireless Charging Unit

- Charge smartphones and tablets wirelessly.
- Fixing via 80w porthole aperture.
- Charging unit complete with USB power plug.
- Wireless Charging Receiver required when device does not support wireless charging.

					Price
WCU/BB	- Charging Unit	- Black	- 85w (dia)	_____	£194
WCU/WW	- Charging Unit	- White	- 85w (dia)	_____	£194
WCU/AB	- Charging Unit	- Aluminium / Black	- 85w (dia)	_____	£236
WCU/AW	- Charging Unit	- Aluminium / White	- 85w (dia)	_____	£236
WCU/BG	- Charging Unit	- Black Glass	- 85w (dia)	_____	£250
WCU/WG	- Charging Unit	- White Glass	- 85w (dia)	_____	£250



WCU/BB
Black Body and Trim



WCU/WW
White Body and Trim



WCU/AB
Black Body and Aluminium Trim



WCU/AW
White Body and Aluminium Trim



WCU/BG
Black Glass Body and Trim



WCU/WG
White Glass Body and Trim



WCU/DP/BGB

Dual Pro Wireless Charging Unit

- Lid cover slides to reveal 3x USB chargers (type A+A+C).
- Charge smartphones and tablets wirelessly.
- 65W laptop charging without a traditional brick power cord.
- Fixing via 80w porthole aperture.
- Charging unit complete with USB power plug.
- Wireless Charging Receiver required when device does not support wireless charging.

					Price
WCU/DP/BGS	- Dual Pro Charging Unit	- Black Glass with Silver Base	- 203w x 93d x 8h	_____	£283
WCU/DP/WGS	- Dual Pro Charging Unit	- White Glass with Silver Base	- 203w x 93d x 8h	_____	£283
WCU/DP/BGB	- Dual Pro Charging Unit	- Black Glass with Black Base	- 203w x 93d x 8h	_____	£283
WCU/DP/WGB	- Dual Pro Charging Unit	- White Glass with Black Base	- 203w x 93d x 8h	_____	£283



WCU/DP/BGS
Black Glass with Silver Base



WCU/DP/WGS
White Glass with Silver Base



WCU/DP/BGB
Black Glass with Black Base



WCU/DP/WGB
White Glass with Black Base



WCU/WCR

Wireless Charging Receiver

- Charge smartphones and tablets wirelessly.
- Wireless Charging Unit required to support wireless charging.

				Price
WCU/WCR	- Wireless Charging Receiver	_____	_____	£119

Conference / Meeting Power Modules

Lead Time: Standard (All products are manufactured to order and when 'Standard Lead Time' is quoted (7 – 10 days), this may vary dependant on volume ordered, factory capacity and distribution requirements at the time of ordering. For more information please contact your Dealer Business Manager or the Customer Services Team for clarification.)

Finish: Port Hole: Available with Grey Body, Black Body or White Body

Finish: Pix: Available with Black Body with Silver Trim or White Body with White Trim

Guarantee: 1 Year Guarantee on All Electrical Items - Flex Modules Conform to BS5733 and BS6396:2008 Guidelines



PHPM/G

Port Hole Power and Media Module

- 1x 3.15 amp individually fused socket. • 1x USB twin charger (type A+A).
- 1m connection lead. • Fixing via 80w porthole aperture.
- Requires a separate mains lead if connecting directly into a socket (see page 195).
- USB twin charger (type A+A) will be changing to type A+C during 2021-2022.

Price

PHPM/G	- 1x Power, 1x USB Twin Charger	- Grey	- 95w (dia)	_____	£192
PHPM/B	- 1x Power, 1x USB Twin Charger	- Black	- 95w (dia)	_____	£192
PHPM/W	- 1x Power, 1x USB Twin Charger	- White	- 95w (dia)	_____	£192



PHPM/G
Grey



PHPM/B
Black



PHPM/W
White



POW/PIX/1P1T/B

Pix Power and Media Module

- 1x 3.15 amp individually fused socket. • 1x USB twin charger (type A+C).
- 800mm connection lead. • Fixing via 80w porthole aperture.
- Requires a separate mains lead if connecting directly into a socket (see page 319).

Price

POW/PIX/1P1T/B	- 1x Power, 1x USB Twin Charger	- Black	- 90w (dia) x 16h	_____	£237
POW/PIX/1P1T/W	- 1x Power, 1x USB Twin Charger	- White	- 90w (dia) x 16h	_____	£237



POW/PIX/1P1T/B
Black



POW/PIX/1P1T/W
White



Conference / Meeting Power Modules

Lead Time: Standard (All products are manufactured to order and when 'Standard Lead Time' is quoted (7 – 10 days), this may vary dependant on volume ordered, factory capacity and distribution requirements at the time of ordering. For more information please contact your Dealer Business Manager or the Customer Services Team for clarification.)

Finish: Pluto: Available with Grey Body with Black Inserts, Black Body with Grey Inserts and White Body with Grey Inserts

Finish: Inca: Available with Grey Body, Black Body or White Body

Guarantee: 1 Year Guarantee on All Electrical Items



PLU/3P/G

Pluto Power Module

- 3x 3.15 amp individually fused sockets. • Fixing via 80w porthole aperture.
- Requires a separate mains lead if connecting directly into a socket (see page 195).

		Price
PLU/3P/G	- 3x Power - Grey Body / Black Inserts - 140w (dia) x 73h	£230
PLU/3P/B	- 3x Power - Black Body / Grey Inserts - 140w (dia) x 73h	£230
PLU/3P/W	- 3x Power - White Body / Grey Inserts - 140w (dia) x 73h	£230



PLU/2P/1USB/G

Pluto Power and Media Module

- 2x 3.15 amp individually fused sockets. • 1x USB twin charger (type A+C).
- Fixing via 80w porthole aperture.
- Requires a separate mains lead if connecting directly into a socket (see page 195).

		Price
PLU/2P/1USB/G	- 2x Power, 1x USB Twin Charger - Grey Body / Black Inserts - 140w (dia) x 73h	£374
PLU/2P/1USB/B	- 2x Power, 1x USB Twin Charger - Black Body / Grey Inserts - 140w (dia) x 73h	£374
PLU/2P/1USB/W	- 2x Power, 1x USB Twin Charger - White Body / Grey Inserts - 140w (dia) x 73h	£374



PLU2P/1USB/G
Grey Body with Black Inserts



PLU2P/1USB/B
Black Body with Grey Inserts



PLU2P/1USB/W
White Body with Grey Inserts



IPM/G

Inca Power and Media Module

- 2x 3.15 amp individually fused sockets. • 2x USB twin chargers (type A+A).
- Hardwired 1000mm mains lead to male Wieland. • Fixing via 80w porthole aperture.
- Requires a separate mains lead if connecting directly into a socket (see page 195).
- USB twin charger (type A+A) will be changing to type A+C during 2021-2022.

		Price
IPM/G	- 2x Power, 2x USB Twin Charger - Grey - 140w x 140d x 72h	£417
IPM/B	- 2x Power, 2x USB Twin Charger - Black - 140w x 140d x 72h	£417
IPM/W	- 2x Power, 2x USB Twin Charger - White - 140w x 140d x 72h	£417



IPM/G
Grey



IPM/B
Black



IPM/W
White



Conference / Meeting Accessories

Lead Time: Standard (All products are manufactured to order and when 'Standard Lead Time' is quoted (7 – 10 days), this may vary dependant on volume ordered, factory capacity and distribution requirements at the time of ordering. For more information please contact your Dealer Business Manager or the Customer Services Team for clarification.)

Guarantee: 1 Year Guarantee on All Electrical Items



5M

Wieland Mains Cable

• Black plug.

	Price
7M - 7000w	£31
5M - 5000w	£24
3M - 3000w	£19
2M - 2000w	£17



CL10

Wieland Interconnection Cable

• Black interconnection plugs.

	Price
CL20 - 2000w	£15
CL10 - 1000w	£13
CL5 - 500w	£12

Conference / Meeting Accessory Compatibility

- **BLACK** - Compatible
- **RED** - May not support larger modules
- **GREEN** - Unspecified

	Power and Data Modules	Kaspa and Prime, page 309	Boardroom, Conus and Peak, page 310-312	Escalate, page 312	Wireless Charging Unit, page 313	Port Hole and Pix, page 314	Pluto and Inca, page 315
Progress Plus - Height Adjustable Conference / Meeting		●	●	●	●	●	●
Aerofoil - Conference		●	●	●	●	●	●
Lux - Conference / Meeting (Excluding 1000w Circular)		●	●	●	●	●	●
Lux - 1000w Circular		●	●	●	●	●	●
Reflex - Conference / Meeting (Excluding 1000w Circular)		●	●	●	●	●	●
Reflex - 1000w Circular		●	●	●	●	●	●
Qube - 1400d and Above		●	●	●	●	●	●
Qube - 1200d		●	●	●	●	●	●
Qube - 1000d		●	●	●	●	●	●
Progress - Conference / Meeting		●	●	●	●	●	●
Linnea - Conference / Meeting		●	●	●	●	●	●
Matrix - Height Settable Meeting		●	●	●	●	●	●
Matrix - Conference / Meeting		●	●	●	●	●	●
Optima Plus - Conference / Meeting		●	●	●	●	●	●
Callisto - Conference / Meeting		●	●	●	●	●	●
Windsor - Conference		●	●	●	●	●	●

Modular Meeting

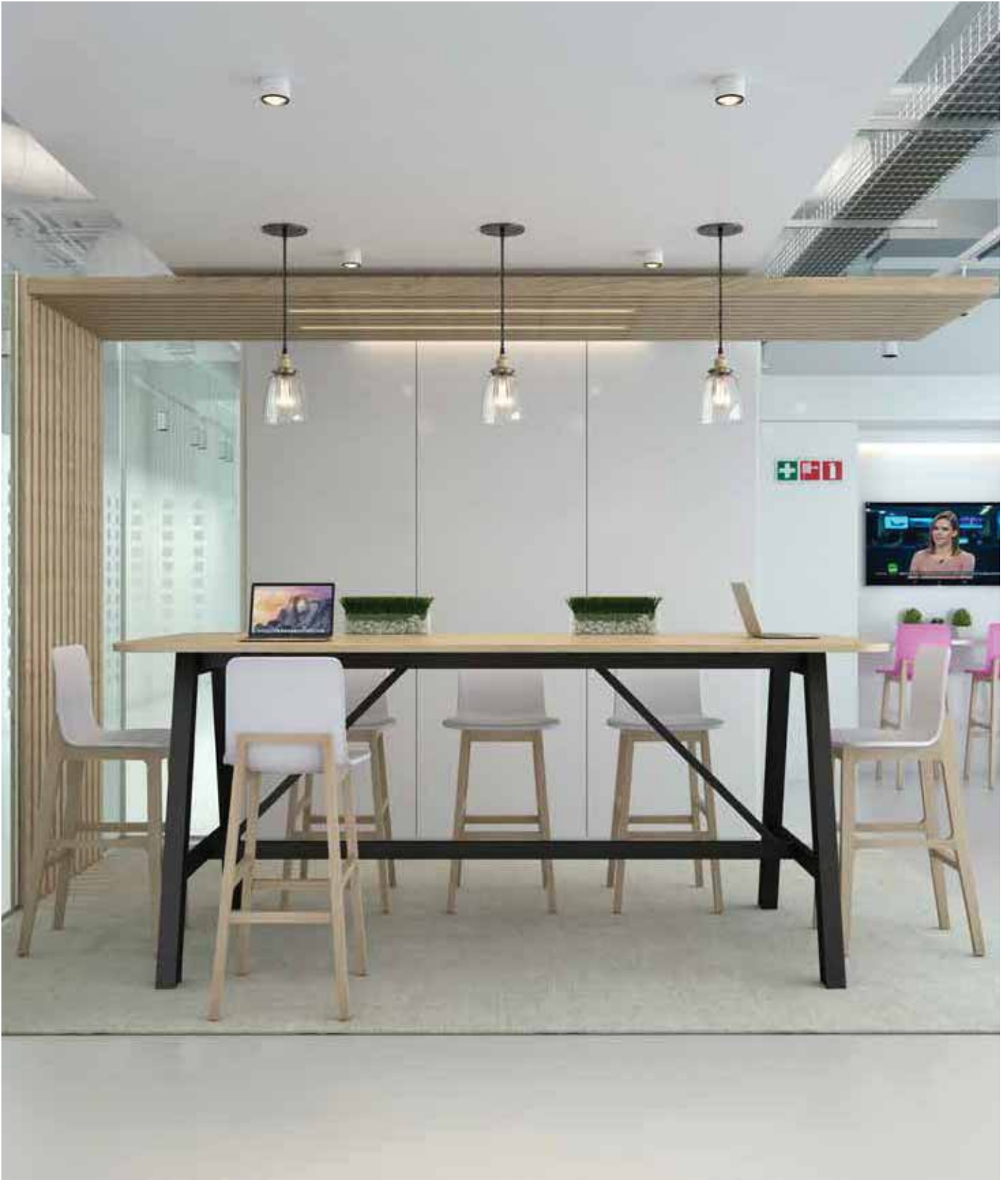

Collaboration and agile working environments are an important aspect of the modern workspace, where flexible ways of working drive business requirements. Elite's modular table portfolio provides flexible solutions, ranging from high-level benches to modular flip-top tables for transient meeting spaces. An extensive range of high and mid-level benches allow for informal meeting and breakout areas while maintaining a professional appearance. A wide range of coffee tables, varying in style, has been designed to complement Elite's breakout seating creating a more cohesive environment.

Modular Meeting Alto and Harmony Bench Tables

Lead Time: 3 Weeks (Veneer and Solid Oak) and Standard (MFC) (All products are manufactured to order and when 'Standard Lead Time' is quoted (7 – 10 days), this may vary dependant on volume ordered, factory capacity and distribution requirements at the time of ordering. For more information please contact your Dealer Business Manager or the Customer Services Team for clarification.)

Wood: Available in MFC (Ash, Autumn Cherry, Beech, Chester Oak, English Walnut, Grey, Grey Nebraska Oak, Laurentii Wenge, Natural Nebraska Oak and White)
Top Panel Edge Detail available on 25mm White MFC (Wenge and Black - Add £32 Retail Per Top) (Plywood - Add £42 Retail Per Top)
Available in Veneer (Oak and Walnut) and Solid Oak on a 3 Week Lead Time

Metalwork: Available in Silver RAL 9006 (Standard), Black Graphite RAL 9004, White RAL 9003, Chrome Effect (Add 15%) and Raw finish (Add 5%)
Also available in Blue RAL 5001, Coral RAL 2001, Green RAL 6016, Light Grey RAL 7038, Teal RAL 5018 and Yellow RAL 1021 (Add 12% for all - 2 Week Lead Time)



AB24/12

Alto Bench with Support Frame

- 3 week lead time on Benches with Solid Oak.
- 25mm MFC and Veneer top panels and 32mm Solid Oak top panels.
- Heavy duty 'A' frame legs with cross bracing frame.
- Benches with MFC and Veneer are supplied 1050h with radiused corners.
- Benches with Solid Oak are supplied 1057h with 90 degree corners.

	MFC	Veneer (3 Week Lead Time)	Solid Oak (3 Week Lead Time)
AB30/12 - 3000w x 1200d x 1050/1057h	£1,596	-	£3,315
AB28/12 - 2800w x 1200d x 1050/1057h	£1,532	-	£3,134
AB26/12 - 2600w x 1200d x 1050/1057h	£1,468	£2,286	£2,958
AB24/12 - 2400w x 1200d x 1050/1057h	£1,405	£2,159	£2,777
AB22/12 - 2200w x 1200d x 1050/1057h	£1,341	£2,033	£2,601



HB20/9

Harmony Bench with Support Frame

- 3 week lead time on Benches with Solid Oak.
- 25mm MFC and Veneer top panels and 32mm Solid Oak top panels.
- 'A' frame legs with cross bracing frame.
- Benches with MFC and Veneer are supplied 1050h with radiused corners.
- Benches with Solid Oak are supplied 1057h with 90 degree corners.

	MFC	Veneer (3 Week Lead Time)	Solid Oak (3 Week Lead Time)
HB20/9 - 2000w x 900d x 1050/1057h	£936	£1,409	£1,796



HB16/9

Harmony Bench

- 3 week lead time on Benches with Solid Oak. • 'A' frame legs.
- 25mm MFC and Veneer top panels and 32mm Solid Oak top panels.
- Benches with MFC and Veneer are supplied 1050h with radiused corners.
- Benches with Solid Oak are supplied 1057h with 90 degree corners.

	MFC	Veneer (3 Week Lead Time)	Solid Oak (3 Week Lead Time)
HB18/9 - 1800w x 900d x 1050/1057h	£902	£1,327	£1,640
HB16/9 - 1600w x 900d x 1050/1057h	£868	£1,248	£1,524
HB14/9 - 1400w x 900d x 1050/1057h	£836	£1,165	£1,408



LB16/8

Loco Bench

- 3 week lead time on Benches with Solid Oak. • 'A' frame legs.
- 25mm MFC and Veneer top panels and 32mm Solid Oak top panels.
- Benches with MFC and Veneer are supplied 740h with radiused corners.
- Benches with Solid Oak are supplied 747h with 90 degree corners.

	MFC	Veneer (3 Week Lead Time)	Solid Oak (3 Week Lead Time)
LB20/8 - 2000w x 800d x 740/747h	£836	£1,253	£1,600
LB18/8 - 1800w x 800d x 740/747h	£803	£1,182	£1,460
LB16/8 - 1600w x 800d x 740/747h	£769	£1,105	£1,354
LB14/8 - 1400w x 800d x 740/747h	£736	£1,029	£1,247



LBS15

Loco Seat

- 3 week lead time on Benches with Solid Oak. • 'A' frame legs.
- 25mm MFC and Veneer top panels and 32mm Solid Oak top panels.
- Benches with MFC and Veneer are supplied 465h with radiused corners.
- Benches with Solid Oak are supplied 472h with 90 degree corners.

	MFC	Veneer (3 Week Lead Time)	Solid Oak (3 Week Lead Time)
LBS19 - 1900w x 330d x 465/472h	£635	£800	£1,029
LBS17 - 1700w x 330d x 465/472h	£610	£755	£952
LBS15 - 1500w x 330d x 465/472h	£582	£711	£884
LBS13 - 1300w x 330d x 465/472h	£557	£668	£818

Modular Meeting Loco Bench Tables

Lead Time: Standard (All products are manufactured to order and when 'Standard Lead Time' is quoted (7 – 10 days), this may vary dependant on volume ordered, factory capacity and distribution requirements at the time of ordering. For more information please contact your Dealer Business Manager or the Customer Services Team for clarification.)

Wood: Available in MFC (Ash, Autumn Cherry, Beech, Chester Oak, English Walnut, Grey, Grey Nebraska Oak, Laurentii Wenge, Natural Nebraska Oak and White)
Top Panel Edge Detail available on 25mm White MFC (Wenge and Black - Add £32 Retail Per Top) (Plywood - Add £42 Retail Per Top)

Metalwork: Available in Silver RAL 9006 (Standard), Black Graphite RAL 9004, White RAL 9003, Chrome Effect (Add 15%) and Raw finish (Add 5%)
Also available in Blue RAL 5001, Coral RAL 2001, Green RAL 6016, Light Grey RAL 7038, Teal RAL 5018 and Yellow RAL 1021 (Add 12% for all - 2 Week Lead Time)

Fabric: Group 1-7



LBS15/FSP15

Loco Seat with Full Length Seat Pad

- 'A' frame legs. • Tops supplied with radiused corners. • Full length seat pads for the Loco seat.
- Prices shown in MFC only. • Contact Customer Services for Veneer and Solid Oak.

	Group 1	Group 2	Group 3	Group 4	Group 5	Group 6	Group 7
LBS19/FSP19 - 1900w x 330d x 495h	£883	£909	£938	£968	£994	£1,040	£1,137
LBS17/FSP17 - 1700w x 330d x 495h	£844	£870	£899	£929	£955	£1,001	£1,098
LBS15/FSP15 - 1500w x 330d x 495h	£802	£829	£858	£887	£914	£959	£1,057
LBS13/FSP13 - 1300w x 330d x 495h	£754	£780	£809	£838	£865	£911	£1,008



LBS15/ISP15

Loco Seat with Individual Seat Pads

- 'A' frame legs. • Tops supplied with radiused corners. • Individual seat pads for the Loco seat.
- Prices shown in MFC only. • Contact Customer Services for Veneer and Solid Oak.

	Group 1	Group 2	Group 3	Group 4	Group 5	Group 6	Group 7
LBS19/ISP19 - 1900w x 330d x 495h	£896	£922	£951	£981	£1,007	£1,053	£1,150
LBS17/ISP17 - 1700w x 330d x 495h	£855	£882	£911	£940	£967	£1,012	£1,110
LBS15/ISP15 - 1500w x 330d x 495h	£813	£840	£868	£898	£924	£970	£1,067
LBS13/ISP13 - 1300w x 330d x 495h	£765	£792	£820	£850	£877	£922	£1,020



HBCR
Illustrated in red

Bench Cable Riser

- Single channel cable riser.

	Metalwork
ABCR - For Alto Benches	£56
HBCR - For Harmony Benches	£54
LBRCR - For Loco Benches	£48



HBCT16/9
Illustrated in red

Horizontal Cable Tray

- Tray can be positioned to the users side of the workstation or towards the rear.
- Cable trays are 100mm deep and 110mm high.

	Metalwork
ABCT30/12 - For AB30/12 - 2200w	£211
ABCT28/12 - For AB28/12 - 2000w	£195
ABCT26/12 - For AB26/12 - 1800w	£179
ABCT24/12 - For AB24/12 - 1600w	£163
ABCT22/12 - For AB22/12 - 1400w	£148
HBCT20/9 - For HB20/9 - 1600w	£163
HBCT18/9 - For HB18/9 - 1400w	£148
HBCT16/9 - For HB16/9 - 1200w	£129
HBCT14/9 - For HB14/9 - 1000w	£111



CWMT16
Illustrated in red

Horizontal Cable Tray

- High capacity cable management system neatly conceals power, data and telecom cables through a hinged cable management tray.
- Cable trays are 130mm deep and 75mm high.

	Metalwork
CWMT20 - For LB20/8 - 1600w	£148
CWMT18 - For LB18/8 - 1400w	£129
CWMT16 - For LB16/8 - 1200w	£114
CWMT14 - For LB14/8 - 1000w	£96

Modular Meeting Cubeform Bench Tables

Lead Time: Standard (All products are manufactured to order and when 'Standard Lead Time' is quoted (7 – 10 days), this may vary dependant on volume ordered, factory capacity and distribution requirements at the time of ordering. For more information please contact your Dealer Business Manager or the Customer Services Team for clarification.)

Wood: Available in MFC (Ash, Autumn Cherry, Beech, Chester Oak, English Walnut, Grey, Grey Nebraska Oak, Laurentii Wenge, Natural Nebraska Oak and White)
Top Panel Edge Detail available on 25mm White MFC (Wenge and Black - Add £32 Retail Per Top) (Plywood - Add £42 Retail Per Top)
Available in Nanotech (Black)

Metalwork: Available in Silver RAL 9006 (Standard), Black Graphite RAL 9004, White RAL 9003 and Raw finish (Add 5%)
Also available in Blue RAL 5001, Coral RAL 2001, Green RAL 6016, Light Grey RAL 7038, Teal RAL 5018 and Yellow RAL 1021 (Add 12% for all - 2 Week Lead Time)



CF/RB16/8

Cubeform Rectangular Bench

- 25mm top panel.
- Central support rail.

CF/RB16/8 - 1600w x 800d x 740h

CF/RB14/8 - 1400w x 800d x 740h

CF/RB12/8 - 1200w x 800d x 740h

CF/RB16/6 - 1600w x 600d x 740h

CF/RB14/6 - 1400w x 600d x 740h

CF/RB12/6 - 1200w x 600d x 740h

	MFC	Black Nanotech
CF/RB16/8	£428	£548
CF/RB14/8	£406	£510
CF/RB12/8	£382	£471
CF/RB16/6	£406	£495
CF/RB14/6	£382	£458
CF/RB12/6	£357	£423



Modular Meeting Cubeform Bench Seats

Lead Time: Standard (All products are manufactured to order and when 'Standard Lead Time' is quoted (7 – 10 days), this may vary dependant on volume ordered, factory capacity and distribution requirements at the time of ordering. For more information please contact your Dealer Business Manager or the Customer Services Team for clarification.)

Wood: Available in MFC (Ash, Autumn Cherry, Beech, Chester Oak, English Walnut, Grey, Grey Nebraska Oak, Laurentii Wenge, Natural Nebraska Oak and White)
Top Panel Edge Detail available on 25mm White MFC (Wenge and Black - Add £32 Retail Per Top) (Plywood - Add £42 Retail Per Top)
Available in Nanotech (Black)

Metalwork: Available in Silver RAL 9006 (Standard), Black Graphite RAL 9004, White RAL 9003 and Raw finish (Add 5%)
Also available in Blue RAL 5001, Coral RAL 2001, Green RAL 6016, Light Grey RAL 7038, Teal RAL 5018 and Yellow RAL 1021 (Add 12% for all - 2 Week Lead Time)

Fabric: Group 1-7



CF/RSS5

Cubeform Rectangular Single Seat with MFC Seat

- Complete with MFC seat. • 25mm top panel.

	MFC	Black Nanotech
CF/RSS8 - 800w x 350d x 465h	£393	£420
CF/RSS5 - 475w x 350d x 465h	£363	£379



CF/RSS5/F

Cubeform Rectangular Single Seat with Fully Upholstered Seat

- Complete with upholstered seat.

		Fabric
CF/RSS8/F - 800w x 350d x 530h	Group 1	£545
	Group 2	£562
	Group 3	£579
	Group 4	£598
	Group 5	£618
	Group 6	£638
	Group 7	£688
CF/RSS5/F - 475w x 350d x 530h	Group 1	£474
	Group 2	£489
	Group 3	£504
	Group 4	£517
	Group 5	£532
	Group 6	£550
	Group 7	£595



CF/RDS14

Cubeform Rectangular Bench Seat with MFC Seat

- Complete with MFC seat. • 25mm top panel.

	MFC	Black Nanotech
CF/RDS14 - 1400w x 350d x 465h	£442	£485
CF/RDS12 - 1200w x 350d x 465h	£411	£451
CF/RDS10 - 1000w x 350d x 465h	£382	£414



CF/RDS14/F

Cubeform Rectangular Bench Seat with Fully Upholstered Seat

- Complete with upholstered seat.

		Fabric
CF/RDS14/F - 1400w x 350d x 530h	Group 1	£664
	Group 2	£691
	Group 3	£720
	Group 4	£749
	Group 5	£780
	Group 6	£810
	Group 7	£882
CF/RDS12/F - 1200w x 350d x 530h	Group 1	£611
	Group 2	£635
	Group 3	£661
	Group 4	£688
	Group 5	£713
	Group 6	£742
	Group 7	£812
CF/RDS10/F - 1000w x 350d x 530h	Group 1	£558
	Group 2	£579
	Group 3	£603
	Group 4	£626
	Group 5	£651
	Group 6	£676
	Group 7	£742

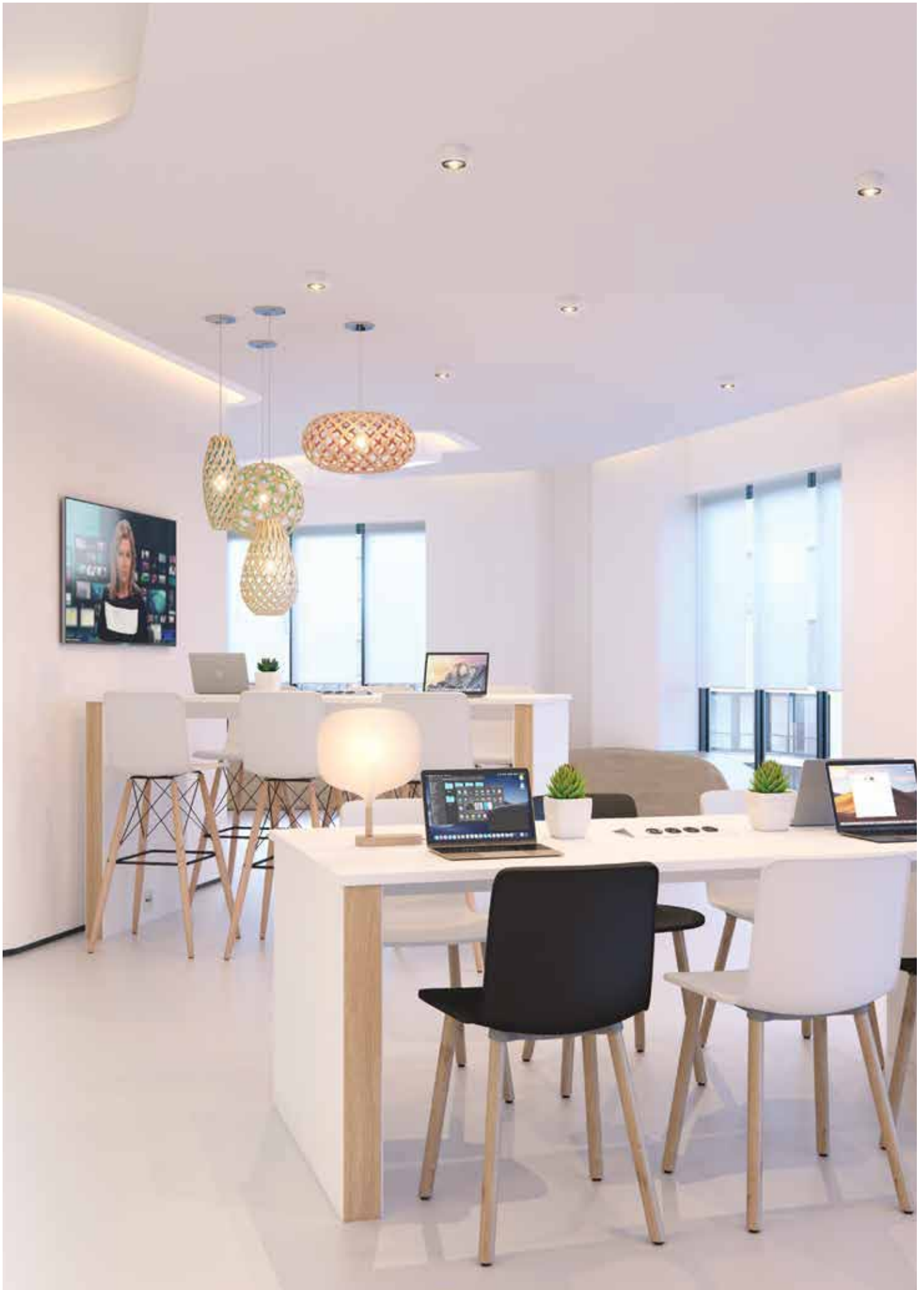

Lead Time: 2 Weeks

Wood: Available in MFC (Ash, Autumn Cherry, Beech, Chester Oak, English Walnut, Grey, Grey Nebraska Oak, Laurentii Wenge, Natural Nebraska Oak and White)
 Top Panel Edge Detail available on 25mm White MFC (Wenge and Black - Add £32 Retail Per Top) (Plywood - Add £42 Retail Per Top)
 Available in Veneer (Oak and Walnut) on a 3 Week Lead Time

Metalwork: Available in Silver RAL 9006 only



FORHB20/9

Forte High Bench Table

- 2 week lead time. • 25mm top panel.
- Panel ended benches. • Horizontal Cable tray included.
- Vertical cable management access within each panel end via a 80mm cable port.

• For Contrasting Edge Finishes, see **Contrasting Finish** section below
 Further information required, contact Customer Services for specification form.

		MFC	Veneer (3 Week Lead Time)
FORHB22/10	- 2200w x 1000d x 1050h	£1,511	£2,342
FORHB20/10	- 2000w x 1000d x 1050h	£1,448	£2,245
FORHB18/10	- 1800w x 1000d x 1050h	£1,388	£2,152
FORHB16/10	- 1600w x 1000d x 1050h	£1,325	£2,055
FORHB22/9	- 2200w x 900d x 1050h	£1,388	£2,152
FORHB20/9	- 2000w x 900d x 1050h	£1,325	£2,055
FORHB18/9	- 1800w x 900d x 1050h	£1,265	£1,961
FORHB16/9	- 1600w x 900d x 1050h	£1,202	£1,867



FORB20/9

Forte Bench Table

- 2 week lead time. • 25mm top panel.
- Panel ended benches. • Horizontal Cable tray included.
- Vertical cable management access within each panel end via a 80mm cable port.

• For Contrasting Edge Finishes, see **Contrasting Finish** section below
 Further information required, contact Customer Services for specification form.

		MFC	Veneer (3 Week Lead Time)
FORB22/10	- 2200w x 1000d x 740h	£1,303	£2,017
FORB20/10	- 2000w x 1000d x 740h	£1,240	£1,924
FORB18/10	- 1800w x 1000d x 740h	£1,180	£1,827
FORB16/10	- 1600w x 1000d x 740h	£1,116	£1,731
FORB22/9	- 2200w x 900d x 740h	£1,265	£1,961
FORB20/9	- 2000w x 900d x 740h	£1,202	£1,867
FORB18/9	- 1800w x 900d x 740h	£1,142	£1,770
FORB16/9	- 1600w x 900d x 740h	£1,080	£1,674

Contrasting Finish

- Standard Top Panel Edge Detail applied as normal.
- Contrasting Finish to be chosen from Standard Dual Board MFC Finishes only.
- To apply a contrasting finish from the Desktop Surface (A) to the Leg (C), add **£25** and suffix **.../CONAC** to your chosen unit, and submit a Forte Specification Form.
- To apply a contrasting finish from the Legs Main Surface (C) to its Edge (D), add **£25** and suffix **.../CONCD** to your chosen unit, and submit a Forte Specification Form.
- To apply a contrasting finish from the Desktop Surface (A) to the Leg (C), and from the Legs Main Surface (C) to its Edge (D), add **£50** and suffix **.../CONACD** to your chosen unit, and submit a Forte Specification Form.

		Price
.../CONAC	- 'A' contrasting to 'C'	£25
.../CONCD	- 'C' contrasting to 'D'	£25
.../CONACD	- 'A' contrasting to 'C' and 'C' contrasting to 'D'	£50

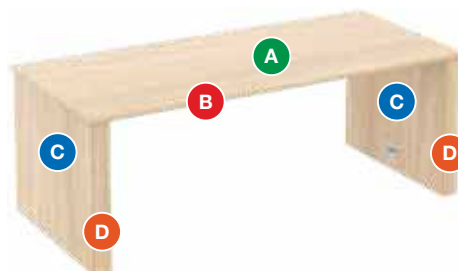

- A** Desktop Surface
- B** Desktop Edge
- C** Leg Main Surface
- D** Leg Main Edge



Lead Time: 2 Weeks

Wood: Available in MFC (Ash, Autumn Cherry, Beech, Chester Oak, English Walnut, Grey, Grey Nebraska Oak, Laurentii Wenge, Natural Nebraska Oak and White)
Top Panel Edge Detail available on 25mm White MFC (Wenge and Black - Add £32 Retail Per Top) (Plywood - Add £42 Retail Per Top)
Available in Veneer (Oak and Walnut) on a 3 Week Lead Time

Metalwork: Available in Silver RAL 9006 (Standard), Black Graphite RAL 9004 and White RAL 9003

Finishes: Available in the finishes detailed below



LUXHB32/12/ASL

Lux High Bench Table

• 2 week lead time. • 2x 25mm top panels. • Tapered legs with adjustable levelling feet and steel sub-frame. • Available with radiused corners, suffix .../RC (see below).

	MFC	Veneer (3 Week Lead Time)
LUXHB40/12... - 2x Sections - 4000w x 1200d x 1050h	£3,999	£4,662
LUXHB36/12... - 2x Sections - 3600w x 1200d x 1050h	£3,870	£4,507
LUXHB32/12... - 2x Sections - 3200w x 1200d x 1050h	£3,738	£4,349
LUXHB30/12... - 2x Sections - 3000w x 1200d x 1050h	£3,658	£4,271
LUXHB40/10... - 2x Sections - 4000w x 1000d x 1050h	£3,854	£4,491
LUXHB36/10... - 2x Sections - 3600w x 1000d x 1050h	£3,725	£4,333
LUXHB32/10... - 2x Sections - 3200w x 1000d x 1050h	£3,597	£4,177
LUXHB30/10... - 2x Sections - 3000w x 1000d x 1050h	£3,529	£4,099

- Add £0 for Ash (.../ASL)
- Add £111 for Stained Walnut (.../WAL)
- Add £129 for Stained Espresso (.../ESL), Wenge (.../WEL) and Black (.../BKL)
- Add £174 for White (.../WHL)



LUXHB16/12/ASL

Lux High Bench Table

• 2 week lead time. • 25mm top panel. • Tapered legs with adjustable levelling feet and steel sub-frame. • Available with radiused corners, suffix .../RC (see below).

	MFC	Veneer (3 Week Lead Time)
LUXHB24/12... - 1x Section - 2400w x 1200d x 1050h	£2,585	£3,013
LUXHB22/12... - 1x Section - 2200w x 1200d x 1050h	£2,439	£2,833
LUXHB20/12... - 1x Section - 2000w x 1200d x 1050h	£2,291	£2,660
LUXHB18/12... - 1x Section - 1800w x 1200d x 1050h	£2,142	£2,483
LUXHB16/12... - 1x Section - 1600w x 1200d x 1050h	£1,999	£2,307
LUXHB14/12... - 1x Section - 1400w x 1200d x 1050h	£1,933	£2,229
LUXHB24/10... - 1x Section - 2400w x 1000d x 1050h	£2,521	£2,933
LUXHB22/10... - 1x Section - 2200w x 1000d x 1050h	£2,371	£2,754
LUXHB20/10... - 1x Section - 2000w x 1000d x 1050h	£2,227	£2,582
LUXHB18/10... - 1x Section - 1800w x 1000d x 1050h	£2,080	£2,405
LUXHB16/10... - 1x Section - 1600w x 1000d x 1050h	£1,933	£2,229
LUXHB14/10... - 1x Section - 1400w x 1000d x 1050h	£1,870	£2,153

- Add £0 for Ash (.../ASL)
- Add £74 for Stained Walnut (.../WAL)
- Add £86 for Stained Espresso (.../ESL), Wenge (.../WEL) and Black (.../BKL)
- Add £116 for White (.../WHL)



.../RC

Lux Optional Radiused Corners

• Adds a radius to 4 corners of specific Lux high benches.
• Suffix .../RC to the end of relevant Lux codes.

.../RC - Radiused Corners	Price
.../RC	£64



LCTR20
Illustrated in red

Lux Cable Tray

• Compatible with all Lux high benches.
• High capacity cable management system neatly conceals power, data and telecom cables through a hinged cable management tray. • Cable trays are 180mm deep and 80mm high.

	Metalwork
LCTR40 - For 4000w High Bench Tables - 1500w (2x)	£250
LCTR36 - For 3600w High Bench Tables - 1300w (2x)	£234
LCTR32 - For 3200w High Bench Tables - 1100w (2x)	£218
LCTR30 - For 3000w High Bench Tables - 1000w (2x)	£208
LCTR24 - For 2400w High Bench Tables - 900w (2x)	£190
LCTR22 - For 2200w High Bench Tables - 800w (2x)	£178
LCTR20 - For 2000w High Bench Tables - 1500w	£125
LCTR18 - For 1800w High Bench Tables - 1300w	£117
LCTR16 - For 1600w High Bench Tables - 1100w	£109
LCTR14 - For 1400w High Bench Tables - 900w	£95

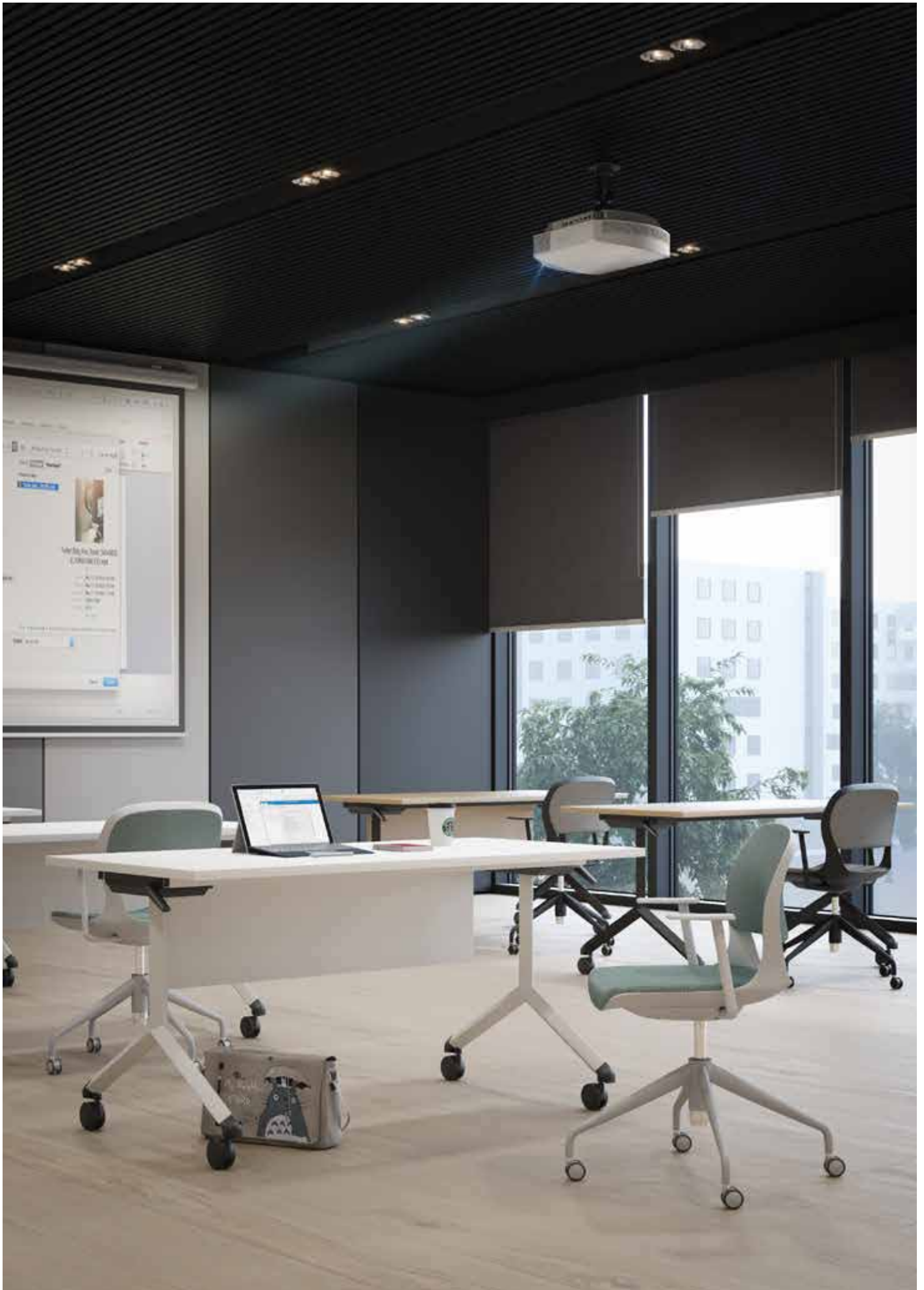

Modular Meeting Tilt Tables

2 Week Lead Time

Lead Time: 2 Weeks

Wood: Available in MFC (Ash, Autumn Cherry, Beech, Chester Oak, English Walnut, Grey, Grey Nebraska Oak, Laurentii Wenge, Natural Nebraska Oak and White)
Top Panel Edge Detail available on 25mm White MFC (Wenge and Black - Add £32 Retail Per Top) (Plywood - Add £42 Retail Per Top)
Available in Veneer (Oak and Walnut) on a 3 Week Lead Time

Metalwork: Available in Silver RAL 9006 (Standard), Black Graphite RAL 9004, White RAL 9003 and Raw finish (Add 5%)
Also available in Blue RAL 5001, Coral RAL 2001, Green RAL 6016, Light Grey RAL 7038, Teal RAL 5018 and Yellow RAL 1021 (Add 12% for all)



TIL15/7



TIL15/7



6x TIL15/7

Tilt Fliptop Rectangular Table

- 2 week lead time.
- 25mm top panel.
- Chevron leg frame.
- Folds via quick release lever.
- Enables horizontal nesting of frames.

	MFC	Veneer (3 Week Lead Time)
TIL18/7 - 1800w x 750d x 755h	£761	£1,199
TIL15/7 - 1500w x 750d x 755h	£711	£1,079
TIL12/7 - 1200w x 750d x 755h	£683	£985
TIL18/6 - 1800w x 600d x 755h	£729	£1,062
TIL15/6 - 1500w x 600d x 755h	£683	£964
TIL12/6 - 1200w x 600d x 755h	£653	£890



TIL/MP15

Tilt Fliptop Modesty Panel Option

- 2 week lead time.
- Retrofits option.
- Folds into vertical position when the release lever is activated.

	MFC	Veneer (3 Week Lead Time)
TIL/MP18 - 1400w x 300h	£116	£174
TIL/MP15 - 1100w x 300h	£110	£165
TIL/MP12 - 800w x 300h	£104	£156



FTLP

Tilt Table Link Plate

- Table tops are pre-drilled for ease of fitting.
- The red markers below indicate the pre-drilled positions on the above tables.

FTLP	Price
	£30



Rectangular Table

Modular Meeting Fliptop Tables

Lead Time: Standard (All products are manufactured to order and when 'Standard Lead Time' is quoted (7 – 10 days), this may vary dependant on volume ordered, factory capacity and distribution requirements at the time of ordering. For more information please contact your Dealer Business Manager or the Customer Services Team for clarification.)

Wood: Available in MFC (Ash, Autumn Cherry, Beech, Chester Oak, English Walnut, Grey, Grey Nebraska Oak, Laurentii Wenge, Natural Nebraska Oak and White)
Top Panel Edge Detail available on 25mm White MFC (Wenge and Black - Add £32 Retail Per Top) (Plywood - Add £42 Retail Per Top)
Available in Veneer (Oak and Walnut) on a 3 Week Lead Time

Metalwork: Available in Silver RAL 9006 Only



FTT16

Fliptop Rectangular Table

- 25mm top panel.
- Silver tubular upright and cross frame.
- Brushed aluminium support feet.
- Heavy duty release and flip mechanism.
- 2x lockable castors.
- Available in Silver RAL 9006 only.

FTT16 - 1600w x 800d x 740h

FTT14 - 1400w x 800d x 740h

FTT12 - 1200w x 800d x 740h

	MFC	Veneer (3 Week Lead Time)
FTT16	£731	£1,115
FTT14	£679	£1,015
FTT12	£632	£932



FTT08C

Fliptop Circular Table

- 25mm top panel.
- Silver tubular upright and cross frame.
- Brushed aluminium support feet.
- Heavy duty release and flip mechanism.
- Protective glides.
- Available in Silver RAL 9006 only.

FTT08C - 800w (dia) x 725h

	MFC	Veneer (3 Week Lead Time)
FTT08C	£720	£921



FTT16SC

Fliptop Semi-circular Table

- 25mm top panel.
- Silver tubular upright and cross frame.
- Brushed aluminium support feet.
- Heavy duty release and flip mechanism.
- 2x lockable castors.
- Available in Silver RAL 9006 only.

FTT16SC - 1600w (dia) x 725h

	MFC	Veneer (3 Week Lead Time)
FTT16SC	£826	£1,185



FTLP

Fliptop Table Link Plate

- Table tops are pre-drilled for ease of fitting.
- The red markers below indicate the pre-drilled positions on the above tables.

FTLP

Price

£30



Rectangular Table

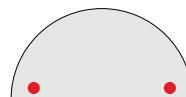

Semi-circular Table

Modular Meeting Folding and Training Tables

Lead Time: Standard (All products are manufactured to order and when 'Standard Lead Time' is quoted (7 – 10 days), this may vary dependant on volume ordered, factory capacity and distribution requirements at the time of ordering. For more information please contact your Dealer Business Manager or the Customer Services Team for clarification.)

Wood: Available in MFC (Ash, Autumn Cherry, Beech, Chester Oak, English Walnut, Grey, Grey Nebraska Oak, Laurentii Wenge, Natural Nebraska Oak and White)
Top Panel Edge Detail available on 25mm White MFC (Wenge and Black - Add £32 Retail Per Top) (Plywood - Add £42 Retail Per Top)

Metalwork: Available in Veneer (Oak and Walnut) on a 3 Week Lead Time
Folding Tables: Available in Silver RAL 9006 Only
Training Tables: Available in Silver RAL 9006 (Standard), Black Graphite RAL 9004, White RAL 9003, Chrome Effect (Add 15%) and Raw finish (Add 5%)
Also available in Blue RAL 5001, Coral RAL 2001, Green RAL 6016, Light Grey RAL 7038, Teal RAL 5018 and Yellow RAL 1021 (Add 12% for all - 2 Week Lead Time)



FT16

Folding Rectangular Table

- 25mm top panel. • 30mm diameter leg frames. • Folded height 130mm.
- Adjustable feet for levelling purposes. • Available in Silver RAL 9006 only.

		MFC	Veneer (3 Week Lead Time)
FT18	- Straight Leg - 1800w x 800d x 735h	£524	£955
FT16	- Straight Leg - 1600w x 800d x 735h	£499	£885
FT14	- Straight Leg - 1400w x 800d x 735h	£476	£812
FT12	- Straight Leg - 1200w x 800d x 735h	£454	£757



TR16

Rectangular Training Table

- 25mm top panel.
- Welded underframe on 40mm diameter tubular legs.
- Adjustable feet for levelling purposes.



		MFC	Veneer (3 Week Lead Time)
TR18	- 1800w x 800d x 740h	£434	£865
TR16	- 1600w x 800d x 740h	£400	£784
TR14	- 1400w x 800d x 740h	£374	£708
TR12	- 1200w x 800d x 740h	£341	£643
TR10	- 1000w x 800d x 740h	£326	£567
TR08	- 800w x 800d x 740h	£314	£514
TR18/6	- 1800w x 600d x 740h	£412	£738
TR16/6	- 1600w x 600d x 740h	£379	£669
TR14/6	- 1400w x 600d x 740h	£353	£603
TR12/6	- 1200w x 600d x 740h	£321	£537
TR10/6	- 1000w x 600d x 740h	£311	£490
TR08/6	- 800w x 600d x 740h	£299	£449



TSC16

Semi-circular Training Table

- 25mm top panel.
- Welded underframe on 40mm diameter tubular legs.
- Adjustable feet for levelling purposes.



		MFC	Veneer (3 Week Lead Time)
TSC16	- 1600w x 800d x 740h	£650	£1,035



TT16

Trapezoidal Training Table

- 25mm top panel.
- Welded underframe on 40mm diameter tubular legs.
- Angled ends are 800mm wide.
- Adjustable feet for levelling purposes.



		MFC	Veneer (3 Week Lead Time)
TT16	- 1600w x 690d x 740h	£650	£1,035
TT14	- 1400w x 690d x 740h	£596	£932

Modular Meeting Training Tables

Lead Time: Standard (All products are manufactured to order and when 'Standard Lead Time' is quoted (7 – 10 days), this may vary dependant on volume ordered, factory capacity and distribution requirements at the time of ordering. For more information please contact your Dealer Business Manager or the Customer Services Team for clarification.)

Wood: Available in MFC (Ash, Autumn Cherry, Beech, Chester Oak, English Walnut, Grey, Grey Nebraska Oak, Laurentii Wenge, Natural Nebraska Oak and White)
Top Panel Edge Detail available on 25mm White MFC (Wenge and Black - Add £32 Retail Per Top) (Plywood - Add £42 Retail Per Top)
Available in Veneer (Oak and Walnut) on a 3 Week Lead Time

Metalwork: Available in Silver RAL 9006 (Standard), Black Graphite RAL 9004, White RAL 9003, Chrome Effect (Add 15%) and Raw finish (Add 5%)
Also available in Blue RAL 5001, Coral RAL 2001, Green RAL 6016, Light Grey RAL 7038, Teal RAL 5018 and Yellow RAL 1021 (Add 12% for all - 2 Week Lead Time)



TRSQ16

Rectangular Training Table with Square Legs

- 25mm top panel.
- Welded underframe on 35mm x 35mm square legs.
- Adjustable feet for levelling purposes.



Square Leg

		MFC	Veneer (3 Week Lead Time)
TRSQ18	- 1800w x 800d x 740h	£434	£865
TRSQ16	- 1600w x 800d x 740h	£400	£784
TRSQ14	- 1400w x 800d x 740h	£374	£708
TRSQ12	- 1200w x 800d x 740h	£341	£643
TRSQ10	- 1000w x 800d x 740h	£326	£567
TRSQ08	- 800w x 800d x 740h	£314	£514
TRSQ18/6	- 1800w x 600d x 740h	£412	£738
TRSQ16/6	- 1600w x 600d x 740h	£379	£669
TRSQ14/6	- 1400w x 600d x 740h	£353	£603
TRSQ12/6	- 1200w x 600d x 740h	£321	£537
TRSQ10/6	- 1000w x 600d x 740h	£311	£490
TRSQ08/6	- 800w x 600d x 740h	£299	£449



TSCSQ16

Semi-circular Training Table with Square Legs

- 25mm top panel.
- Welded underframe on 35mm x 35mm square legs.
- Adjustable feet for levelling purposes.



Square Leg

TSCSQ16	- 1600w x 800d x 740h	£650	£1,035
----------------	-----------------------	------	--------

MFC
**Veneer
(3 Week
Lead Time)**



TTSQ16

Trapezoidal Training Table with Square Legs

- 25mm top panel.
- Welded underframe on 35mm x 35mm square legs.
- Angled ends are 800mm wide.
- Adjustable feet for levelling purposes.



Square Leg

TTSQ16	- 1600w x 690d x 740h	£650	£1,035
TTSQ14	- 1400w x 690d x 740h	£596	£932

MFC
**Veneer
(3 Week
Lead Time)**

Modular Meeting Vista Meeting Tables

Lead Time: Standard (All products are manufactured to order and when 'Standard Lead Time' is quoted (7 – 10 days), this may vary dependant on volume ordered, factory capacity and distribution requirements at the time of ordering. For more information please contact your Dealer Business Manager or the Customer Services Team for clarification.)

Wood: Available in MFC (Ash, Autumn Cherry, Beech, Chester Oak, English Walnut, Grey, Grey Nebraska Oak, Laurentii Wenge, Natural Nebraska Oak and White)
Top Panel Edge Detail available on 25mm White MFC (Wenge and Black - Add £32 Retail Per Top) (Plywood - Add £42 Retail Per Top)
Available in Veneer (Oak and Walnut) on a 3 Week Lead Time

Metalwork: Available in Brushed Aluminium Only



VISR16/8

Vista Rectangular Training Table

- 25mm top panel.
- Brushed aluminium chevron leg frames supported by black steel subframe.
- Adjustable feet for levelling purposes.

	MFC	Veneer (3 Week Lead Time)
VISR18/9 - 1800w x 900d x 750h	£624	£971
VISR16/9 - 1600w x 900d x 750h	£611	£950
VISR14/9 - 1400w x 900d x 750h	£596	£928
VISR12/9 - 1200w x 900d x 750h	£582	£905
VISR18/8 - 1800w x 800d x 750h	£611	£950
VISR16/8 - 1600w x 800d x 750h	£596	£928
VISR14/8 - 1400w x 800d x 750h	£582	£905
VISR12/8 - 1200w x 800d x 750h	£567	£884
VISR18/7 - 1800w x 700d x 750h	£596	£928
VISR16/7 - 1600w x 700d x 750h	£582	£905
VISR14/7 - 1400w x 700d x 750h	£567	£884
VISR12/7 - 1200w x 700d x 750h	£554	£863



Lead Time: 3 Weeks
Wood: Available in MDF (White) with Undercut Edge
Finishes: Available in the finishes detailed below



PIA/REC16/09

Piazza Rectangular Meeting Table

- 3 week lead time.
- 30mm top panel.
- Solid ash square legs with protective glides.
- White epoxy powder coated leg plates.

MDF

PIA/REC16/09... - 1600w x 900d x 725h _____ | £806

- Add £0 for Ash (.../ASL)
- Add £54 for Walnut (.../WAL)
- Add £63 for Stained Espresso (.../ESL), Wenge (.../WEL) or Black (.../BKL)
- Add £83 for White (.../WHL)



PIA/SQR09

Piazza Square Meeting Table

- 3 week lead time.
- 30mm top panel.
- Solid ash square legs with protective glides.
- White epoxy powder coated leg plates.

MDF

PIA/SQR09... - 900w x 900d x 725h _____ | £689

- Add £0 for Ash (.../ASL)
- Add £54 for Walnut (.../WAL)
- Add £63 for Stained Espresso (.../ESL), Wenge (.../WEL) or Black (.../BKL)
- Add £83 for White (.../WHL)



PIA/CIR10

Piazza Circular Meeting Table

- 3 week lead time.
- 30mm top panel.
- Solid ash square legs with protective glides.
- White epoxy powder coated leg plates.

MDF

PIA/CIR12... - 1200w (dia) x 725h _____ | £787
PIA/CIR10... - 1000w (dia) x 725h _____ | £723
PIA/CIR08... - 800w (dia) x 725h _____ | £639

- Add £0 for Ash (.../ASL)
- Add £54 for Walnut (.../WAL)
- Add £63 for Stained Espresso (.../ESL), Wenge (.../WEL) or Black (.../BKL)
- Add £83 for White (.../WHL)



Modular Meeting Tondo Meeting Tables

Lead Time: Standard (All products are manufactured to order and when 'Standard Lead Time' is quoted (7 – 10 days), this may vary dependant on volume ordered, factory capacity and distribution requirements at the time of ordering. For more information please contact your Dealer Business Manager or the Customer Services Team for clarification.)

Wood: Available in MDF (White) with Undercut Edge

Finishes: Available in the finishes detailed below



TON/REC16/09

Tondo Rectangular Meeting Table

- 30mm top panel. • Solid beech round legs with protective glides.
- White epoxy powder coated leg plates.

MDF

TON/REC16/09... - 1600w x 900d x 720h

£660

- Add £0 for Beech (.../BEL)
- Add £40 for Walnut (.../WAL)
- Add £50 for Stained Espresso (.../ESL), Wenge (.../WEL) or Black (.../BKL)
- Add £69 for White (.../WHL)



TON/SQR09

Tondo Square Meeting Table

- 30mm top panel. • Solid beech round legs with protective glides.
- White epoxy powder coated leg plates.

MDF

TON/SQR09... - 900w x 900d x 720h

£542

- Add £0 for Beech (.../BEL)
- Add £40 for Walnut (.../WAL)
- Add £50 for Stained Espresso (.../ESL), Wenge (.../WEL) or Black (.../BKL)
- Add £69 for White (.../WHL)



TON/CIR10

Tondo Circular Meeting Table

- 30mm top panel. • Solid beech round legs with protective glides.
- White epoxy powder coated leg plates.

MDF

TON/CIR12... - 1200w (dia) x 720h

£639

TON/CIR10... - 1000w (dia) x 720h

£580

TON/CIR08... - 800w (dia) x 720h

£495

- Add £0 for Beech (.../BEL)
- Add £40 for Walnut (.../WAL)
- Add £50 for Stained Espresso (.../ESL), Wenge (.../WEL) or Black (.../BKL)
- Add £69 for White (.../WHL)



Modular Meeting Meeting Tables

Lead Time: Standard (All products are manufactured to order and when 'Standard Lead Time' is quoted (7 – 10 days), this may vary dependant on volume ordered, factory capacity and distribution requirements at the time of ordering. For more information please contact your Dealer Business Manager or the Customer Services Team for clarification.)

Wood: Available in MFC (Ash, Autumn Cherry, Beech, Chester Oak, English Walnut, Grey, Grey Nebraska Oak, Laurentii Wenge, Natural Nebraska Oak and White)
Top Panel Edge Detail available on 25mm White MFC (Wenge and Black - Add £32 Retail Per Top) (Plywood - Add £42 Retail Per Top)
Available in Veneer (Oak and Walnut) on a 3 Week Lead Time

Metalwork: MT01, MT02, MT03 and MT04: Available in Silver RAL 9006 (Standard), Black Graphite RAL 9004 and White RAL 9003
Also available in Blue RAL 5001, Coral RAL 2001, Green RAL 6016, Light Grey RAL 7038, Teal RAL 5018 and Yellow RAL 1021 (Add 12% for all - 2 Week Lead Time)
MT05: Available in Chrome Only



Square / Circular Meeting Table

- 25mm top panel. • Wire managed base, 80mm aperture, located within the column.
- 100mm square column. • Heavy duty weighted 505mm square x 15mm deep base.
- Levelling feet.

	MFC	Veneer (3 Week Lead Time)
MT01/SQR10 - Square Top - 1000w x 1000d x 740h	£638	£939
MT01/SQR08 - Square Top - 800w x 800d x 740h	£585	£787
MT01/CIR12 - Circular Top - 1200w (dia) x 740h	£802	£1,160
MT01/CIR10 - Circular Top - 1000w (dia) x 740h	£750	£1,052
MT01/CIR08 - Circular Top - 800w (dia) x 740h	£701	£901



Square / Circular Meeting Table

- 25mm top panel. • 80mm diameter column. • 500mm square x 5mm deep base.

	MFC	Veneer (3 Week Lead Time)
MT02/SQR08 - Square Top - 800w x 800d x 720h	£438	£638
MT02/SQR06 - Square Top - 600w x 600d x 720h	£418	£586
MT02/CIR10 - Circular Top - 1000w (dia) x 720h	£603	£903
MT02/CIR08 - Circular Top - 800w (dia) x 720h	£550	£750
MT02/CIR06 - Circular Top - 600w (dia) x 720h	£532	£703



Square / Circular Meeting Table

- 25mm top panel. • 80mm diameter column. • 600mm diameter x 5mm deep base.

	MFC	Veneer (3 Week Lead Time)
MT03/SQR08 - Square Top - 800w x 800d x 720h	£438	£638
MT03/SQR06 - Square Top - 600w x 600d x 720h	£418	£586
MT03/CIR10 - Circular Top - 1000w (dia) x 720h	£603	£903
MT03/CIR08 - Circular Top - 800w (dia) x 720h	£550	£750
MT03/CIR06 - Circular Top - 600w (dia) x 720h	£532	£703



Square / Circular Meeting Table

- 25mm top panel. • 120mm diameter column.
- Heavy duty weighted 685mm diameter domed base with rolled edge.

	MFC	Veneer (3 Week Lead Time)
MT04/SQR10 - Square Top - 1000w x 1000d x 725h	£559	£859
MT04/SQR08 - Square Top - 800w x 800d x 725h	£506	£706
MT04/CIR12 - Circular Top - 1200w (dia) x 725h	£736	£1,093
MT04/CIR10 - Circular Top - 1000w (dia) x 725h	£672	£973
MT04/CIR08 - Circular Top - 800w (dia) x 725h	£620	£822



Square / Circular Chrome Trumpet Based Meeting Table

- 25mm top panel. • 60mm diameter column. • Weighted 490mm diameter trumpet base.
- Protective feet. • Available in Chrome only.

	MFC	Veneer (3 Week Lead Time)
MT05/SQR08 - Square Top - 800w x 800d x 725h	£528	£729
MT05/SQR06 - Square Top - 600w x 600d x 725h	£509	£679
MT05/CIR10 - Circular Top - 1000w (dia) x 725h	£694	£994
MT05/CIR08 - Circular Top - 800w (dia) x 725h	£643	£844
MT05/CIR06 - Circular Top - 600w (dia) x 725h	£624	£793

Modular Meeting Meeting Tables

Lead Time: Standard (All products are manufactured to order and when 'Standard Lead Time' is quoted (7 – 10 days), this may vary dependant on volume ordered, factory capacity and distribution requirements at the time of ordering. For more information please contact your Dealer Business Manager or the Customer Services Team for clarification.)

Wood: Available in MFC (Ash, Autumn Cherry, Beech, Chester Oak, English Walnut, Grey, Grey Nebraska Oak, Laurentii Wenge, Natural Nebraska Oak and White)
Top Panel Edge Detail available on 25mm White MFC (Wenge and Black - Add £32 Retail Per Top) (Plywood - Add £42 Retail Per Top)
Available in Veneer (Oak and Walnut) on a 3 Week Lead Time

Metalwork: MT06, MT07 and MT08: Available in Silver RAL 9006 (Standard), Black Graphite RAL 9004 and White RAL 9003
Also available in Blue RAL 5001, Coral RAL 2001, Green RAL 6016, Light Grey RAL 7038, Teal RAL 5018 and Yellow RAL 1021 (Add 12% for all - 2 Week Lead Time)

MT09HA and MT10HA: Available in the finishes detailed below



MT06/SQR8

Square / Circular Pyramid Based Meeting Table

- 25mm top panel. • 60mm diameter column.
- 490mm square x 8mm deep pyramid base. • Levelling feet.

	MFC	Veneer (3 Week Lead Time)
MT06/SQR08 - Square Top - 800w x 800d x 725h	£514	£714
MT06/SQR06 - Square Top - 600w x 600d x 725h	£497	£664
MT06/CIR10 - Circular Top - 1000w (dia) x 725h	£682	£982
MT06/CIR08 - Circular Top - 800w (dia) x 725h	£629	£828
MT06/CIR06 - Circular Top - 600w (dia) x 725h	£611	£780



MT07/CIR10

Square / Circular Trumpet Based Meeting Table

- 25mm top panel. • 60mm diameter column.
- Weighted 470mm diameter x 5mm deep base. • Protective feet.

	MFC	Veneer (3 Week Lead Time)
MT07/SQR08 - Square Top - 800w x 800d x 725h	£444	£643
MT07/SQR06 - Square Top - 600w x 600d x 725h	£423	£593
MT07/CIR10 - Circular Top - 1000w (dia) x 725h	£610	£911
MT07/CIR08 - Circular Top - 800w (dia) x 725h	£559	£759
MT07/CIR06 - Circular Top - 600w (dia) x 725h	£538	£739



MT08/CIR10

Square / Circular Trumpet Based Meeting Table

- 25mm top panel. • 50mm diameter column.
- Weighted 480mm diameter trumpet base. • Levelling feet.

	MFC	Veneer (3 Week Lead Time)
MT08/SQR08 - Square Top - 800w x 800d x 725h	£616	£816
MT08/SQR06 - Square Top - 600w x 600d x 725h	£597	£765
MT08/CIR10 - Circular Top - 1000w (dia) x 725h	£781	£1,081
MT08/CIR08 - Circular Top - 800w (dia) x 725h	£729	£930
MT08/CIR06 - Circular Top - 600w (dia) x 725h	£709	£865



MT09HA/CIR10

Circular Sit / Stand Meeting Table

- 25mm top panel. • 725mm-1050mm height adjustment. • 95mm diameter gas lift column.
- Heavy duty weighted 675mm diameter domed base with rolled edge.
- Available in Silver RAL 9006 or White RAL 9003 only.

	MFC	Veneer (3 Week Lead Time)
MT09HA/CIR12... - Circular Top - 1200w (dia) x 725-1050h	£1,423	£1,779
MT09HA/CIR10... - Circular Top - 1000w (dia) x 725-1050h	£1,370	£1,671

- Add £0 for Silver
- Add £0 for White (.../W)



MT10HA/CIR10

Circular Mobile Sit / Stand Meeting Table

- 25mm top panel. • 725mm-1050mm height adjustment. • 95mm diameter gas lift column.
- Mobile 920mm diameter four-legged base with locking castors.
- Available in Silver RAL 9006 or White RAL 9003 only.

	MFC	Veneer (3 Week Lead Time)
MT10HA/CIR12... - Circular Top - 1200w (dia) x 725-1050h	£1,836	£2,194
MT10HA/CIR10... - Circular Top - 1000w (dia) x 725-1050h	£1,784	£2,084

- Add £0 for Silver
- Add £0 for White (.../W)

Modular Meeting Meeting Tables

Lead Time: Standard (All products are manufactured to order and when 'Standard Lead Time' is quoted (7 – 10 days), this may vary dependant on volume ordered, factory capacity and distribution requirements at the time of ordering. For more information please contact your Dealer Business Manager or the Customer Services Team for clarification.)

Wood: Available in MFC (Ash, Autumn Cherry, Beech, Chester Oak, English Walnut, Grey, Grey Nebraska Oak, Laurentii Wenge, Natural Nebraska Oak and White)
Top Panel Edge Detail available on 25mm White MFC (Wenge and Black - Add £32 Retail Per Top) (Plywood - Add £42 Retail Per Top)
Available in Veneer (Oak and Walnut) on a 3 Week Lead Time

Metalwork: MT11 and MT12: Available in Chrome Only
CTB: Available in the finishes detailed below
MT13: Available in Silver RAL 9006 (Standard), Black Graphite RAL 9004 and White RAL 9003
Also available in Blue RAL 5001, Coral RAL 2001, Green RAL 6016, Light Grey RAL 7038, Teal RAL 5018 and Yellow RAL 1021 (Add 12% for all - 2 Week Lead Time)



MT11/SQR10

Square / Circular Meeting Table for Cascara

- 25mm top panel. • 50mm diameter column.
- 655mm four-star base. • Available in Chrome only.
- Complements Cascara seating range (See the Elite Seating Guide).

	MFC	Veneer (3 Week Lead Time)
MT11/SQR10 - Square Top - 1000w x 1000d x 725h	£596	£897
MT11/SQR08 - Square Top - 800w x 800d x 725h	£542	£744
MT11/CIR10 - Circular Top - 1000w (dia) x 725h	£708	£1,010
MT11/CIR08 - Circular Top - 800w (dia) x 725h	£657	£859



CTB/CIR08/7/P4S

Canterbury Square / Circular Meeting Table

- 25mm top panel. • Polished or black aluminium four-star base.
- Complements Tempo, Elipsa, Cascara, Myla and Luma seating ranges (See the Elite Seating Guide).

	MFC	Veneer (3 Week Lead Time)
CTB/SQR10/7 - Square Top - 1000w x 1000d x 750h	£584	£884
CTB/SQR08/7 - Square Top - 800w x 800d x 750h	£530	£732
CTB/CIR10/7 - Circular Top - 1000w (dia) x 750h	£695	£996
CTB/CIR08/7 - Circular Top - 800w (dia) x 750h	£647	£846

- Add £0 for Polished Base (.../P4S)
- Add £15 for Black Base (.../B4S)



CTB/CIR08/7/B4S



MT12/SQR10

Square / Circular Meeting Table

- 25mm top panel. • 50mm diameter column. • 680mm four-star base.
- Levelling feet. • Available in Chrome only.

	MFC	Veneer (3 Week Lead Time)
MT12/SQR10 - Square Top - 1000w x 1000d x 725h	£580	£882
MT12/SQR08 - Square Top - 800w x 800d x 725h	£528	£729
MT12/CIR10 - Circular Top - 1000w (dia) x 725h	£694	£994
MT12/CIR08 - Circular Top - 800w (dia) x 725h	£643	£844



MT13/CIR15

Circular Meeting Table

- 25mm top panel. • 60mm diameter post legs.
- Fully welded four-legged frame. • Levelling feet.

	MFC	Veneer (3 Week Lead Time)
MT13/CIR15 - Circular Top - 1500w (dia) x 725h	£701	£1,273

Modular Meeting Bar Tables

Lead Time: Standard (All products are manufactured to order and when 'Standard Lead Time' is quoted (7 – 10 days), this may vary dependant on volume ordered, factory capacity and distribution requirements at the time of ordering. For more information please contact your Dealer Business Manager or the Customer Services Team for clarification.)

Wood: Available in MFC (Ash, Autumn Cherry, Beech, Chester Oak, English Walnut, Grey, Grey Nebraska Oak, Laurentii Wenge, Natural Nebraska Oak and White)
Top Panel Edge Detail available on 25mm White MFC (Wenge and Black - Add £32 Retail Per Top) (Plywood - Add £42 Retail Per Top)
Available in Veneer (Oak and Walnut) on a 3 Week Lead Time

Metalwork: BT02, BT03, BT06, BT07 and BT08: Available in Silver RAL 9006 (Standard), Black Graphite RAL 9004 and White RAL 9003
Also available in Blue RAL 5001, Coral RAL 2001, Green RAL 6016, Light Grey RAL 7038, Teal RAL 5018 and Yellow RAL 1021 (Add 12% for all - 2 Week Lead Time)
Available in Chrome Only

BT05:



BT02/SQR8

Square Bar Table

- 25mm top panel.
- 80mm diameter column.
- 500mm square x 5mm deep base.

MFC **Veneer (3 Week Lead Time)**

BT02/SQR08 - Square Top - 800w x 800d x 1100h

£455

£656

BT02/SQR06 - Square Top - 600w x 600d x 1100h

£441

£583



BT03/CIR8

Circular Bar Table

- 25mm top panel.
- 80mm diameter column.
- 600mm diameter x 5mm deep base.

MFC **Veneer (3 Week Lead Time)**

BT03/CIR08 - Circular Top - 800w (dia) x 1100h

£597

£782

BT03/CIR06 - Circular Top - 600w (dia) x 1100h

£580

£724



BT05/SQR06

Square / Circular Trumpet Based Bar Table

- 25mm top panel.
- 60mm diameter column.
- Weighted 490mm circular base.
- Protective feet.
- Available in Chrome only.

MFC **Veneer (3 Week Lead Time)**

BT05/SQR06 - Square Top - 600w x 600d x 1095h

£520

£663

BT05/CIR06 - Circular Top - 600w (dia) x 1095h

£564

£706



BT06/SQR06

Square / Circular Pyramid Based Bar Table

- 25mm top panel.
- 60mm diameter column.
- 475mm square x 8mm deep pyramid base.
- Levelling feet.

MFC **Veneer (3 Week Lead Time)**

BT06/SQR06 - Square Top - 600w x 600d x 1095h

£457

£600

BT06/CIR06 - Circular Top - 600w (dia) x 1095h

£500

£643



BT07/CIR06

Square / Circular Bar Table

- 25mm top panel.
- 60mm diameter column.
- Weighted 470mm diameter x 5mm deep base.
- Protective feet.

MFC **Veneer (3 Week Lead Time)**

BT07/SQR06 - Square Top - 600w x 600d x 1095h

£414

£559

BT07/CIR06 - Circular Top - 600w (dia) x 1095h

£457

£600



BT08/CIR06

Square / Circular Bar Table

- 25mm top panel.
- 50mm diameter column.
- Weighted 480mm diameter trumpet base.
- Levelling feet.

MFC **Veneer (3 Week Lead Time)**

BT08/SQR06 - Square Top - 600w x 600d x 1095h

£602

£745

BT08/CIR06 - Circular Top - 600w (dia) x 1095h

£644

£788

Modular Meeting Coffee Tables

Lead Time: Standard (All products are manufactured to order and when 'Standard Lead Time' is quoted (7 – 10 days), this may vary dependant on volume ordered, factory capacity and distribution requirements at the time of ordering. For more information please contact your Dealer Business Manager or the Customer Services Team for clarification.)

Wood: Available in MFC (Ash, Autumn Cherry, Beech, Chester Oak, English Walnut, Grey, Grey Nebraska Oak, Laurentii Wenge, Natural Nebraska Oak and White) Top Panel Edge Detail available on 25mm White MFC (Wenge and Black - Add £32 Retail Per Top) (Plywood - Add £42 Retail Per Top) Available in Veneer (Oak and Walnut) on a 3 Week Lead Time

Metalwork: CT02 and CT03: Available in Silver RAL 9006 (Standard), Black Graphite RAL 9004 and White RAL 9003 Also available in Blue RAL 5001, Coral RAL 2001, Green RAL 6016, Light Grey RAL 7038, Teal RAL 5018 and Yellow RAL 1021 (Add 12% for all - 2 Week Lead Time)

Others: Available in the finishes detailed below



CT02/SQR10

Square Coffee Table

• 25mm top panel. • 80mm diameter column. • 500mm square x 5mm deep base.

CT02/SQR10 - Square Top - 1000w x 1000d x 425h	£470	£772
CT02/SQR08 - Square Top - 800w x 800d x 425h	£444	£657

MFC **Veneer (3 Week Lead Time)**



CT03/CIR10

Circular Coffee Table

• 25mm top panel. • 80mm diameter column. • 600mm diameter x 5mm deep base.

CT03/CIR10 - Circular Top - 1000w (dia) x 425h	£585	£886
CT03/CIR08 - Circular Top - 800w (dia) x 425h	£559	£772

MFC **Veneer (3 Week Lead Time)**



ELLRCT

Rectangular / Square Coffee Table for Ella

• 25mm top panel. • 5mm steel sled legs. • Chrome effect paint as standard. • Epoxy powder coated finish. • Complements Ella seating range (See the Elite Seating Guide).

ELLRCTL... - Rectangular Top - 1200w x 550d x 405h	£518	£745
ELLRCT... - Rectangular Top - 800w x 550d x 405h	£489	£639
ELLSCTL... - Square Top - 800w x 800d x 405h	£504	£703
ELLSCT... - Square Top - 550w x 550d x 405h	£458	£572

MFC **Veneer (3 Week Lead Time)**

- Chrome Effect as Standard
- Add £0 for Silver (.../SF), Black Graphite (.../BGF) or White (.../WF)
- Add £48 for Black (.../BF), Blue (.../BUF), Coral (.../CRF), Green (.../GNF), Light Grey (.../LGF), Teal (.../TLF) or Yellow (.../YEF)

Rectangular / Square Coffee Table for Evo Plus

• 25mm top panel. • Chromed legs. • Complements Evo Plus seating range (See the Elite Seating Guide).

EVOPRCTL... - Rectangular Top - 1200w x 550d x 405h	£529	£824
EVOPRCT... - Rectangular Top - 800w x 550d x 405h	£484	£759
EVOPSCTL... - Square Top - 700w x 700d x 405h	£507	£809
EVOPSCT... - Square Top - 550w x 550d x 405h	£443	£682

MFC **Veneer (3 Week Lead Time)**

Frame Finishes for Standard Leg

- Chrome Effect as Standard
- Add £43 for Silver (.../SF), Black Graphite (.../BGF) or White (.../WF)
- Add £22 for Black Chrome (.../BCF)
- Add £56 for Black (.../BF), Blue (.../BUF), Coral (.../CRF), Green (.../GNF), Light Grey (.../LGF), Teal (.../TLF) or Yellow (.../YEF)



EVOPRCT

Frame Finishes for Cubeform Leg

- Add £127 for Silver (.../CFL/SF), Black Graphite (.../CFL/BGF) or White (.../CFL/WF)
- Add £213 for Chrome Effect (.../CFL/CF)
- Add £175 for Black (.../CFL/BF), Blue (.../CFL/BUF), Coral (.../CFL/CRF), Green (.../CFL/GNF), Light Grey (.../CFL/LGF), Teal (.../CFL/TLF) or Yellow (.../CFL/YEF)



EVOPRCT/CFL/SF

Modular Meeting Coffee Tables

Lead Time: Standard (All products are manufactured to order and when 'Standard Lead Time' is quoted (7 – 10 days), this may vary dependant on volume ordered, factory capacity and distribution requirements at the time of ordering. For more information please contact your Dealer Business Manager or the Customer Services Team for clarification.)

Wood: Available in MFC (Ash, Autumn Cherry, Beech, Chester Oak, English Walnut, Grey, Grey Nebraska Oak, Laurentii Wenge, Natural Nebraska Oak and White)
Top Panel Edge Detail available on 25mm White MFC (Wenge and Black - Add £32 Retail Per Top) (Plywood - Add £42 Retail Per Top)
Available in Veneer (Oak and Walnut) on a 3 Week Lead Time

Metalwork: CT11 and CT12: Available in Chrome Only
ESC: Available in Chrome (Standard), Silver RAL 9006, Black Graphite RAL 9004 and White RAL 9003
Also available in Blue RAL 5001, Coral RAL 2001, Green RAL 6016, Light Grey RAL 7038, Teal RAL 5018 and Yellow RAL 1021 (Add 12% for all - 2 Week Lead Time)

Others: Available in the finishes detailed below



CT11/SQC08

Squircle / Circular Coffee Table for Cascara

- 25mm top panel. • 50mm diameter column.
- 655mm four-star base. • Available in Chrome only.
- Complements Cascara seating range (See the Elite Seating Guide).

	MFC	Veneer (3 Week Lead Time)
CT11/SQC08 - Squircle Top - 800w x 800d x 425h	£570	-
CT11/SQC06 - Squircle Top - 600w x 600d x 425h	£559	-
CT11/CIR08 - Circular Top - 800w (dia) x 425h	£570	£772



CT12/CIR08

Squircle / Circular Coffee Table

- 25mm top panel. • 50mm diameter column. • 680mm four-star base.
- Levelling feet. • Available in Chrome only.

	MFC	Veneer (3 Week Lead Time)
CT12/SQC08 - Squircle Top - 800w x 800d x 425h	£542	-
CT12/SQC06 - Squircle Top - 600w x 600d x 425h	£528	-
CT12/CIR08 - Circular Top - 800w (dia) x 425h	£542	£744



ESCSQT

Squircle / Circular Coffee Table for Escape

- 25mm top panel. • 12mm chromed wire sled base. • Chrome as standard.
- Complements Escape seating range (See the Elite Seating Guide).

	MFC	Veneer (3 Week Lead Time)
ESCSCT - Squircle Top - 600w x 600d x 415h	£484	-
ESCCCT - Circular Top - 700w (dia) x 415h	£484	£687



CTB/CIR08/4/P4S

Canterbury Squircle / Circular Coffee Table

- 25mm top panel. • Polished or black aluminium four-star base.
- Complements Tempo, Elipsa, Cascara, Myla and Luma seating ranges (See the Elite Seating Guide).

	MFC	Veneer (3 Week Lead Time)
CTB/SQC08/5... - Squircle Top - 800w x 800d x 500h	£560	-
CTB/SQC06/5... - Squircle Top - 600w x 600d x 500h	£546	-
CTB/CIR08/5... - Circular Top - 800w (dia) x 500h	£560	£761
CTB/SQC08/4... - Squircle Top - 800w x 800d x 400h	£547	-
CTB/SQC06/4... - Squircle Top - 600w x 600d x 400h	£534	-
CTB/CIR08/4... - Circular Top - 800w (dia) x 400h	£547	£748

- Add £0 for Polished Base (.../P4S)
- Add £15 for Black Base (.../B4S)



CTB/SQC08/4/B4S

Lead Time: 3 Weeks

Wood: Available in MFC (Ash, Autumn Cherry, Beech, Chester Oak, English Walnut, Grey, Grey Nebraska Oak, Laurentii Wenge, Natural Nebraska Oak and White)
Top Panel Edge Detail available on 25mm White MFC (Wenge and Black - Add £32 Retail Per Top) (Plywood - Add £42 Retail Per Top)
Available in Veneer (Oak and Walnut) on a 3 Week Lead Time

Metalwork: Available in the finishes detailed below



HEN/SQC08/5

Henley Squircle / Circular Coffee Table

- 25mm top panel. • Wooden 4 star pyramid base. • Available at 500h and 400h.
- Complements Elipsa, Cascara, Myla and Luma seating ranges (See the Elite Seating Guide).

			MFC	Veneer (3 Week Lead Time)
HEN/SQC08/5...	- Squircle Top	- 800w x 800d x 500h	£507	-
HEN/SQC06/5...	- Squircle Top	- 600w x 600d x 500h	£493	-
HEN/CIR08/5...	- Circular Top	- 800w (dia) x 500h	£507	£708
HEN/CIR06/5...	- Circular Top	- 600w (dia) x 500h	£493	£685
HEN/SQC08/4...	- Squircle Top	- 800w x 800d x 400h	£489	-
HEN/SQC06/4...	- Squircle Top	- 600w x 600d x 400h	£474	-
HEN/CIR08/4...	- Circular Top	- 800w (dia) x 400h	£489	£690
HEN/CIR06/4...	- Circular Top	- 600w (dia) x 400h	£474	£667

- Add £0 for Ash (.../ASL)
- Add £31 for Stained Walnut (.../WAL)
- Add £36 for Stained Espresso (.../ESL), Wenge (.../WEL) and Black (.../BKL)
- Add £52 for White (.../WHL)



OXFRCT/ESL

Oxford Rounded Rectangular Coffee Table

- 3 week lead time. • 25mm top panel. • Below finishes apply to whole unit on veneered items.
- Complements Kouch seating range (See the Elite Seating Guide).

			MFC	Veneer (3 Week Lead Time)
OXFRCT...	- Rounded Rectangular Top	- 1100w x 700d x 330h	£598	£724

- Add £0 for Beech (.../BEL)
- Add £53 for Walnut (.../WAL)
- Add £67 for Stained Espresso (.../ESL), Wenge (.../WEL) or Black (.../BKL)
- Add £80 for White (.../WHL)



CBGCCT/ESL

Cambridge Circular Coffee Table

- 3 week lead time. • 25mm top panel. • Below finishes apply to whole unit on veneered items.
- Complements Kouch seating range (See the Elite Seating Guide).

			MFC	Veneer (3 Week Lead Time)
CBGCCT...	- Circular Top	- 600w (dia) x 400h	£366	£444

- Add £0 for Beech (.../BEL)
- Add £40 for Walnut (.../WAL)
- Add £53 for Stained Espresso (.../ESL), Wenge (.../WEL) or Black (.../BKL)
- Add £67 for White (.../WHL)

Modular Meeting Coffee Tables

Lead Time: Standard (All products are manufactured to order and when 'Standard Lead Time' is quoted (7 – 10 days), this may vary dependant on volume ordered, factory capacity and distribution requirements at the time of ordering. For more information please contact your Dealer Business Manager or the Customer Services Team for clarification.)

Wood: Available in MFC (Ash, Autumn Cherry, Beech, Chester Oak, English Walnut, Grey, Grey Nebraska Oak, Laurentii Wenge, Natural Nebraska Oak and White)
Top Panel Edge Detail available on 25mm White MFC (Wenge and Black - Add £32 Retail Per Top) (Plywood - Add £42 Retail Per Top)
Available in Nanotech (Black)

Metalwork: Available in Silver RAL 9006 (Standard), Black Graphite RAL 9004, White RAL 9003 and Raw finish (Add 5%)
Also available in Blue RAL 5001, Coral RAL 2001, Green RAL 6016, Light Grey RAL 7038, Teal RAL 5018 and Yellow RAL 1021 (Add 12% for all - 2 Week Lead Time)

Cubeform Rectangular / Square Coffee Table

• 25mm top panel.



CF/SCT1

CF/SCT1 - 475w x 475d x 400h

MFC

£393

Black Nanotech

£414



CF/SCT2

CF/SCT2 - 900w x 900d x 400h

£489

£564



CF/RCT1

CF/RCT1 - 900w x 475d x 400h

£442

£480

Cubeform Rectangular / Square Coffee Table with Base Panel

• 25mm top panel and 18mm base panel.



CF/SCT1/BP

CF/SCT1/BP - 475w x 475d x 400h

MFC

£453

Black Nanotech

£497



CF/SCT2/BP

CF/SCT2/BP - 900w x 900d x 400h

£548

£697



CF/RCT1/BP

CF/RCT1/BP - 900w x 475d x 400h

£501

£579



Modular Meeting Coffee Tables

Lead Time: Standard (All products are manufactured to order and when 'Standard Lead Time' is quoted (7 – 10 days), this may vary dependant on volume ordered, factory capacity and distribution requirements at the time of ordering. For more information please contact your Dealer Business Manager or the Customer Services Team for clarification.)

Wood: Available in MFC (Ash, Autumn Cherry, Beech, Chester Oak, English Walnut, Grey, Grey Nebraska Oak, Laurentii Wenge, Natural Nebraska Oak and White)
Top Panel Edge Detail available on 25mm White MFC (Wenge and Black - Add £32 Retail Per Top) (Plywood - Add £42 Retail Per Top)
Available in Veneer (Oak and Walnut) on a 3 Week Lead Time

Metalwork: SCT800, CCT750L and TCT900: Available in Silver RAL 9006 (Standard), Black Graphite RAL 9004, White RAL 9003 and Chrome Effect (Add 15%)
Also available in Blue RAL 5001, Coral RAL 2001, Green RAL 6016, Light Grey RAL 7038, Teal RAL 5018 and Yellow RAL 1021 (Add 12% for all - 2 Week Lead Time)

Others: Available in the finishes detailed below



RCT900

Rectangular Panel Ended Coffee Table

- 25mm top panel.
- 25mm panel end base.
- Middle support panel.

MFC | **Veneer (3 Week Lead Time)**

RCT900 - Rectangular Top - 900w x 530d x 385h | £368 | £655



CCT750

Circular Coffee Table

- 25mm top panel.
- 25mm panelled cross base.

MFC | **Veneer (3 Week Lead Time)**

CCT750 - Circular Top - 750w (dia) x 400h | £294 | £580



SCT800

Squircle / Circular / Triangular Coffee Table

- 25mm top panel.
- Squircle and circular table has 4 tapered legs.
- Triangular table has 3 tapered legs.

MFC | **Veneer (3 Week Lead Time)**

SCT800 - Squircle Top - 800w x 800d x 400h | £478 | -

CCT750L - Circular Top - 750w (dia) x 400h | £478 | £679

TCT900 - Triangular Top - 900w (dia) x 400h | £461 | -



TCT900



GCT9

Clear Glass Rectangular Coffee Table

- 10mm polished toughened glass.
- Brushed steel and silver rod design.

Price

GCT9 - Rectangular Top - 1200w x 600d x 420h | £453



GCT10

Clear Glass Circular Coffee Table

- 8mm polished toughened glass.
- Silver tubular base.

Price

GCT10 - Circular Top - 500w (dia) x 590h | £335

Modular Meeting TV and Computer Tables

Lead Time: Standard (All products are manufactured to order and when 'Standard Lead Time' is quoted (7 – 10 days), this may vary dependant on volume ordered, factory capacity and distribution requirements at the time of ordering. For more information please contact your Dealer Business Manager or the Customer Services Team for clarification.)

Wood: Available in MFC (Ash, Autumn Cherry, Beech, Chester Oak, English Walnut, Grey, Grey Nebraska Oak, Laurentii Wenge, Natural Nebraska Oak and White)
 Top Panel Edge Detail available on 25mm White MFC (Wenge and Black - Add £32 Retail Per Top) (Plywood - Add £42 Retail Per Top)
 Available in Veneer (Oak and Walnut) on a 3 Week Lead Time

Metalwork: MTVU: Available in Silver RAL 9006 (Standard), Black Graphite RAL 9004, White RAL 9003 and Chrome Effect (Add 15%)
 NOV: Available in Chrome Only
 LUN: Available in Silver RAL 9006 (Standard), Black Graphite RAL 9004, White RAL 9003, Chrome Effect (Add 15%) and Raw finish (Add 5%)
 Also available in Blue RAL 5001, Coral RAL 2001, Green RAL 6016, Light Grey RAL 7038, Teal RAL 5018 and Yellow RAL 1021 (Add 12% for all - 2 Week Lead Time)



MTVU

Mobile TV Unit

- 25mm top panel.
- Horizontal wire management tray (accommodates optional power modules).
- Vertical wire management access via removal of leg upright cover plates.
- Compatible with a TV up to 56".
- Locking castors.
- Universal bracket fixing.
- Maximum TV weight of 50KG.

MTVU - 900w x 800d x 1785h

	MFC	Veneer (3 Week Lead Time)
	£765	£800



LUNT and LUNO

Luna Laptop Table

- 18mm top panel.
- 10mm laser cut steel base.
- 50mm tubular column.
- Protective glides.

LUNT - Trapezoidal Top - 520w x 425d x 630h

LUNO - Oval Top - 600w x 500d x 630h

	MFC	Veneer (3 Week Lead Time)
LUNT	£430	-
LUNO	£430	£570

Modular Meeting Mobile Whiteboard Unit

Lead Time: Standard (All products are manufactured to order and when 'Standard Lead Time' is quoted (7 – 10 days), this may vary dependant on volume ordered, factory capacity and distribution requirements at the time of ordering. For more information please contact your Dealer Business Manager or the Customer Services Team for clarification.)

Metalwork: Available in Silver RAL 9006 (Standard), Black Graphite RAL 9004 and White RAL 9003
Also available in Blue RAL 5001, Coral RAL 2001, Green RAL 6016, Light Grey RAL 7038, Teal RAL 5018 and Yellow RAL 1021 (Add 12% for all - 2 Week Lead Time)



MWBP

Mobile Portrait Whiteboard Unit

- 25mm top panel. • Mobile drywipe whiteboard.
- Portrait (900w x 1200h) or landscape (1200w x 900h) options.
- 360 degree rotation. • Magnetic. • Storage tray. • 2x locking castors.

Price

MWBP - 1000w x 620d x 1850h | £785



MWBL

Mobile Landscape Whiteboard Unit

- 25mm top panel. • Mobile drywipe whiteboard.
- Portrait (900w x 1200h) or landscape (1200w x 900h) options.
- 360 degree rotation. • Magnetic. • Storage tray. • 2x locking castors.

Price

MWBL - 1300w x 620d x 1700h | £813

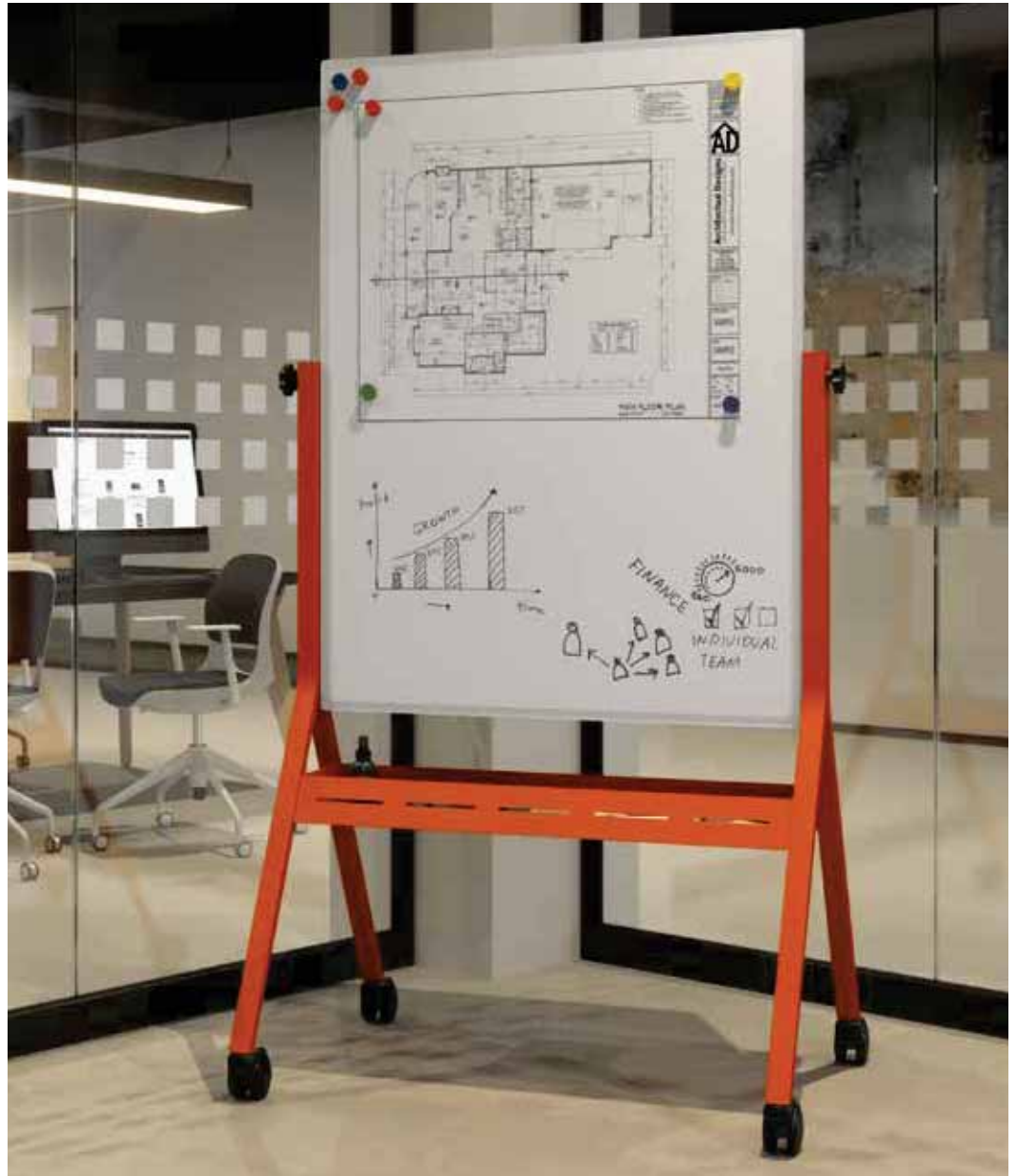

Modular Meeting Accessories

Modular Meeting Accessory Compatibility

- **BLACK** - Compatible
- **RED** - Will not support 4 Gang Modules

	Power and Data Modules	Kaspa and Prime, page 309	Boardroom, Conus and Peak, page 310-312	Escalate, page 312	Wireless Charging Unit, page 313	Port Hole and Pix, page 314	Pluto and Inca, page 315	Flex and Capsule, page 316-317	Plaza and Boost, page 318	Wieland Socket Boxes, page 319
Benches - Alto - 2600w and Above		●	●	●	●	●	●	●		
Benches - Alto - 2400w		●	●	●	●	●	●	●		
Benches - Alto - 2200w				●	●	●	●	●		
Benches - Harmony - 2000w		●	●	●	●	●	●	●		
Benches - Harmony - 1800w and Below		●	●	●	●	●	●	●		
Benches - Loco		●	●	●	●	●	●	●		
Benches - Cubeform Bench Table		●	●	●	●	●	●	●		
Benches - Forte Bench Table		●	●	●	●	●	●	●		
Benches - Lux Bench Table		●	●	●	●	●	●	●		
Fliptop - Rectangular and Semi-circular		●	●	●	●	●	●	●		
Fliptop - Circular									●	
Folding					●		●	●		
Training		●	●	●	●	●	●	●		
Vista		●			●	●	●	●		
Piazza		●	●	●	●	●	●	●		
Tondo		●	●	●	●	●	●	●		
Meeting - MT01					●	●	●	●		
Meeting - MT13		●	●	●	●	●	●	●		
Meeting - All Others									●	
Bar									●	
Coffee - ESC, ELL, EVOP, CCT750L, SCT800 and TCT900		●	●	●	●	●	●	●		
Coffee - Cubeform		●	●	●	●	●	●	●		
Coffee - All Others									●	
TV		●	●	●	●	●	●	●		●
Laptop									●	
Whiteboard										●

Pedestals and Personal Storage



The Elite pedestal portfolio is comprehensive and provides solutions for large volumes, mobile and personal storage. Traditional two-door, tambour fronted storage and pedestals are available in either MFC or Steel structures. Within the units, the internal system can be personalised to meet current and future filing or storage requirements.

Pedestals Low Underdesk Pedestal

Lead Time: Standard (All products are manufactured to order and when 'Standard Lead Time' is quoted (7 – 10 days), this may vary dependant on volume ordered, factory capacity and distribution requirements at the time of ordering. For more information please contact your Dealer Business Manager or the Customer Services Team for clarification.)

Wood: Available in MFC (Ash, Autumn Cherry, Beech, Chester Oak, English Walnut, Grey, Grey Nebraska Oak, Laurentii Wenge, Natural Nebraska Oak and White)
Available in Veneer (Oak and Walnut) on a 3 Week Lead Time

Fabric: Group 1-7



MPF - MPF/SP

2 Drawer Low Mobile Pedestal

- 18mm top panel. • Lockable, includes 2x keys.
- Optional seat pad is 62mm from top of the unit.
- Optional seat pad is supplied with self adhesive pads.
- Alternative handles available (see page 234-235).

MPF - 418w x 600d x 480h
• 1x Single and 1x Filing Drawer

MPF/SP - 418w x 600d x 542h

- 1x Single and 1x Filing Drawer • Supplied with Seat Pad

	MFC	Veneer (3 Week Lead Time)
	£299	£467
Group 1	£405	£572
Group 2	£421	£588
Group 3	£437	£604
Group 4	£455	£622
Group 5	£472	£639
Group 6	£492	£659
Group 7	£538	£705



MP3 - MP3/SP

3 Drawer Low Mobile Pedestal

- 18mm top panel. • Lockable, includes 2x keys.
- Optional seat pad is 62mm from top of the unit.
- Optional seat pad is supplied with self adhesive pads.
- Alternative handles available (see page 234-235).

MP3 - 418w x 600d x 480h
• 3x Single Drawers

MP3/SP - 418w x 600d x 542h

- 3x Single Drawers • Supplied with Seat Pad

	MFC	Veneer (3 Week Lead Time)
	£299	£467
Group 1	£405	£572
Group 2	£421	£588
Group 3	£437	£604
Group 4	£455	£622
Group 5	£472	£639
Group 6	£492	£659
Group 7	£538	£705



MPFM - MPFM/SP

2 Drawer Low Mobile Pedestal on Castors

- 18mm top panel. • Lockable, includes 2x keys.
- Optional seat pad is 62mm from top of the unit.
- Optional seat pad is supplied with self adhesive pads.
- Alternative handles available (see page 234-235).

MPFM - 418w x 600d x 547h
• 1x Single and 1x Filing Drawer

MPFM/SP - 418w x 600d x 609h

- 1x Single and 1x Filing Drawer • Supplied with Seat Pad

	MFC	Veneer (3 Week Lead Time)
	£371	£538
Group 1	£476	£643
Group 2	£492	£659
Group 3	£508	£675
Group 4	£526	£693
Group 5	£543	£710
Group 6	£563	£730
Group 7	£609	£776



MP3M - MP3M/SP

3 Drawer Low Mobile Pedestal on Castors

- 18mm top panel. • Lockable, includes 2x keys.
- Optional seat pad is 62mm from top of the unit.
- Optional seat pad is supplied with self adhesive pads.
- Alternative handles available (see page 234-235).

MP3M - 418w x 600d x 547h
• 3x Single Drawers

MP3M/SP - 418w x 600d x 609h

- 3x Single Drawers • Supplied with Seat Pad

	MFC	Veneer (3 Week Lead Time)
	£371	£538
Group 1	£476	£643
Group 2	£492	£659
Group 3	£508	£675
Group 4	£526	£693
Group 5	£543	£710
Group 6	£563	£730
Group 7	£609	£776

Pedestals Underdesk Pedestal

Lead Time: Standard (All products are manufactured to order and when 'Standard Lead Time' is quoted (7 – 10 days), this may vary dependant on volume ordered, factory capacity and distribution requirements at the time of ordering. For more information please contact your Dealer Business Manager or the Customer Services Team for clarification.)

Wood: Available in MFC (Ash, Autumn Cherry, Beech, Chester Oak, English Walnut, Grey, Grey Nebraska Oak, Laurentii Wenge, Natural Nebraska Oak and White)
Available in Veneer (Oak and Walnut)



MTFP

Mobile Tambour Filing Pedestal on Castors

- 18mm top panel. • Lockable, includes 2x keys. • 1x tambour compartment and filing drawer.
- Filing drawer will accommodate A4 and foolscap filing.
- Alternative handles available (see page 234-235).

MFC **Veneer (3 Week Lead Time)**

MTFP - 420w x 600d x 595h | £648 £936
• Tambour Front and 1x Filing Drawer



DMPO/N

Open Fronted Narrow Mobile Pedestal

- 18mm top panel. • Open fronted for PC tower storage. • Ventilated back panel.

MFC **Veneer (3 Week Lead Time)**

DMPO/N - 298w x 600d x 640h | £360 £563
• Open Fronted



DMPF/N

3 Drawer Narrow Mobile Pedestal

- 18mm top panel. • Lockable, includes 2x keys.
- Alternative handles available (see page 234-235).

MFC **Veneer (3 Week Lead Time)**

DMPF/N - 298w x 600d x 640h | £360 £563
• 2x Single and 1x Filing Drawer

SDMPF/N - 298w x 600d x 640h | £420 £656
• 2x Single and 1x Filing System Drawer



DMP4/N

4 Drawer Narrow Mobile Pedestal

- 18mm top panel. • Lockable, includes 2x keys.
- Alternative handles available (see page 234-235).

MFC **Veneer (3 Week Lead Time)**

DMP4/N - 298w x 600d x 640h | £360 £563
• 4x Single Drawers

SDMP4/N - 298w x 600d x 640h | £420 £656
• 4x Single Drawers



DMPF

3 Drawer Mobile Pedestal

- 18mm top panel. • Lockable, includes 2x keys.
- Alternative handles available (see page 234-235).

MFC **Veneer (3 Week Lead Time)**

DMPF - 418w x 600d x 640h | £382 £595
• 2x Single and 1x Filing Drawer

SDMPF - 418w x 600d x 640h | £453 £666
• 2x Single and 1x Filing System Drawer



DMP4

4 Drawer Mobile Pedestal

- 18mm top panel. • Lockable, includes 2x keys.
- Alternative handles available (see page 234-235).

MFC **Veneer (3 Week Lead Time)**

DMP4 - 418w x 600d x 640h | £382 £595
• 4x Single Drawers

SDMP4 - 418w x 600d x 640h | £453 £666
• 4x Single System Drawers

Pedestals Steel Pedestal

Lead Time: DMSF Pedestals:

Standard (All products are manufactured to order and when 'Standard Lead Time' is quoted (7 – 10 days), this may vary dependant on volume ordered, factory capacity and distribution requirements at the time of ordering. For more information please contact your Dealer Business Manager or the Customer Services Team for clarification.)

NW Pedestals:

4 Weeks

Metalwork: DMSF Pedestals:

Available in Silver RAL 9006 (Standard), Black Graphite RAL 9004 and White RAL 9003

NW Pedestals:

Available in Silver RAL 9006 (Standard), Black AV1 and White BC3



DMSF/N/F

3 Drawer Narrow Steel Flat Fronted Mobile Pedestal

- Lockable, includes 2x keys. • Supplied with pen tray.

Metalwork

DMSF/N/F	- Silver RAL 9006	- 300w x 520d x 600h	_____	£296
DMSF/N/FBG	- Black Graphite RAL 9004	- 300w x 520d x 600h	_____	£296
DMSF/N/FW	- White RAL 9003	- 300w x 520d x 600h	_____	£296

- 2x Single and 1x Filing Drawer



DMSF/F

3 Drawer Steel Flat Fronted Mobile Pedestal

- Lockable, includes 2x keys. • Supplied with pen tray.

Metalwork

DMSF/F	- Silver RAL 9006	- 390w x 520d x 600h	_____	£303
DMSF/FBG	- Black Graphite RAL 9004	- 390w x 520d x 600h	_____	£303
DMSF/FW	- White RAL 9003	- 390w x 520d x 600h	_____	£303

- 2x Single and 1x Filing Drawer



NW35AM711F

3 Drawer Elite Narrow Steel Flat Fronted Mobile Pedestal

- 4 week lead time. • Robust 'vertical wrap' welded steel frame.
- 100% extension file drawers. • Lockable, includes 2x keys. • Supplied with pen tray.

Metalwork

NW35AM711F	- 300w x 565d x 565h	_____	£339
-------------------	----------------------	-------	------

- 2x Single and 1x Filing Drawer



NWA5AM711F

3 Drawer Elite Steel Flat Fronted Mobile Pedestal

- 4 week lead time. • Robust 'vertical wrap' welded steel frame.
- 100% extension file drawers. • Lockable, includes 2x keys. • Supplied with pen tray.

Metalwork

NWA5AM711F	- 420w x 565d x 565h	_____	£339
-------------------	----------------------	-------	------

- 2x Single and 1x Filing Drawer

Pedestals Desk High Pedestal

Lead Time: Standard (All products are manufactured to order and when 'Standard Lead Time' is quoted (7 – 10 days), this may vary dependant on volume ordered, factory capacity and distribution requirements at the time of ordering. For more information please contact your Dealer Business Manager or the Customer Services Team for clarification.)

Wood: Available in MFC (Ash, Autumn Cherry, Beech, Chester Oak, English Walnut, Grey, Grey Nebraska Oak, Laurentii Wenge, Natural Nebraska Oak and White)
Top Panel Edge Detail available on 25mm White MFC (Wenge and Black - Add £32 Retail Per Top) (Plywood - Add £42 Retail Per Top)
Available in Veneer (Oak and Walnut)



DHP2/6

2 Drawer Desk High Pedestal

- 25mm top panel. • Lockable, includes 2x keys. • Anti-tilt device.
- Alternative handles available (see page 234-235).

DHP2/6 - 466w x 600d x 740h
• 2x Filing Drawers

MFC
Veneer (3 Week Lead Time)
£401 £623



DHPF

3 Drawer Desk High Pedestal

- 25mm top panel. • Lockable, includes 2x keys. • Alternative handles available (see page 234-235).

DHPF - 418w x 600d x 740h
• 2x Single and 1x Filing Drawer

SDHPF - 418w x 600d x 740h
• 2x Single and 1x Filing System Drawer

MFC
Veneer (3 Week Lead Time)
£401 £623
£474 £697



DHP4

4 Drawer Desk High Pedestal

- 25mm top panel. • Lockable, includes 2x keys.
- Alternative handles available (see page 234-235).

DHP4 - 418w x 600d x 740h
• 4x Single Drawers

SDHP4 - 418w x 600d x 740h
• 4x Single System Drawers

MFC
Veneer (3 Week Lead Time)
£401 £623
£474 £697



DHP2/8

2 Drawer Deep Desk High Pedestal

- 25mm top panel. • Lockable, includes 2x keys. • Anti-tilt device.
- Alternative handles available (see page 234-235).

DHP2/8 - 466w x 800d x 740h
• 2x Filing Drawers

MFC
Veneer (3 Week Lead Time)
£529 £817



DHPF/8

3 Drawer Deep Desk High Pedestal

- 25mm top panel. • Lockable, includes 2x keys.
- Alternative handles available (see page 234-235).

DHPF/8 - 418w x 800d x 740h
• 2x Single and 1x Filing Drawer

SDHPF/8 - 418w x 800d x 740h
• 2x Single and 1x Filing System Drawer

MFC
Veneer (3 Week Lead Time)
£529 £817
£598 £894



DHP4/8

4 Drawer Deep Desk High Pedestal

- 25mm top panel. • Lockable, includes 2x keys.
- Alternative handles available (see page 234-235).

DHP4/8 - 418w x 800d x 740h
• 4x Single Drawers

SDHP4/8 - 418w x 800d x 740h
• 4x Single System Drawers

MFC
Veneer (3 Week Lead Time)
£529 £817
£598 £894

Pedestals Desk High Pedestal

Lead Time: Standard (All products are manufactured to order and when 'Standard Lead Time' is quoted (7 – 10 days), this may vary dependant on volume ordered, factory capacity and distribution requirements at the time of ordering. For more information please contact your Dealer Business Manager or the Customer Services Team for clarification.)

Wood: Available in MFC (Ash, Autumn Cherry, Beech, Chester Oak, English Walnut, Grey, Grey Nebraska Oak, Laurentii Wenge, Natural Nebraska Oak and White)
Top Panel Edge Detail available on 25mm White MFC (Wenge and Black - Add £32 Retail Per Top) (Plywood - Add £42 Retail Per Top)
Available in Veneer (Oak and Walnut) on a 3 Week Lead Time



DHP2/6L

2 Drawer Desk High Pedestal with Straight Overhanging Top

- 25mm top panel. • Lockable, includes 2x keys. • Anti-tilt device.
- Alternative handles available (see page 234-235).

MFC **Veneer (3 Week Lead Time)**

DHP2/6L - 1000w x 600d x 740h _____

£519 £803

DHP2/6R - 1000w x 600d x 740h _____

£519 £803

- 2x Filing Drawers



DHPF/L

3 Drawer Desk High Pedestal with Straight Overhanging Top

- 25mm top panel. • Lockable, includes 2x keys.
- Alternative handles available (see page 234-235).

MFC **Veneer (3 Week Lead Time)**

DHPF/L - 1000w x 600d x 740h _____

£519 £803

DHPF/R - 1000w x 600d x 740h _____

£519 £803

- 2x Single and 1x Filing Drawer

SDHPF/L - 1000w x 600d x 740h _____

£586 £881

SDHPF/R - 1000w x 600d x 740h _____

£586 £881

- 2x Single and 1x Filing System Drawer



DHP4/L

4 Drawer Desk High Pedestal with Straight Overhanging Top

- 25mm top panel. • Lockable, includes 2x keys.
- Alternative handles available (see page 234-235).

MFC **Veneer (3 Week Lead Time)**

DHP4/L - 1000w x 600d x 740h _____

£519 £803

DHP4/R - 1000w x 600d x 740h _____

£519 £803

- 4x Single Drawers

SDHP4/L - 1000w x 600d x 740h _____

£586 £881

SDHP4/R - 1000w x 600d x 740h _____

£586 £881

- 4x Single System Drawers



DHP2/8L

2 Drawer Deep Desk High Pedestal with Curved Overhanging Top

- 25mm top panel. • Lockable, includes 2x keys. • Anti-tilt device.
- Alternative handles available (see page 234-235).

MFC **Veneer (3 Week Lead Time)**

DHP2/8L - 1000w x 800-600d x 740h _____

£710 £1,099

DHP2/8R - 1000w x 800-600d x 740h _____

£710 £1,099

- 2x Filing Drawers



DHPF/8L

3 Drawer Deep Desk High Pedestal with Curved Overhanging Top

- 25mm top panel. • Lockable, includes 2x keys.
- Alternative handles available (see page 234-235).

MFC **Veneer (3 Week Lead Time)**

DHPF/8L - 1000w x 800-600d x 740h _____

£710 £1,099

DHPF/8R - 1000w x 800-600d x 740h _____

£710 £1,099

- 2x Single and 1x Filing Drawer

SDHPF/8L - 1000w x 800-600d x 740h _____

£780 £1,173

SDHPF/8R - 1000w x 800-600d x 740h _____

£780 £1,173

- 2x Single and 1x Filing System Drawer



DHP4/8L

4 Drawer Deep Desk High Pedestal with Curved Overhanging Top

- 25mm top panel. • Lockable, includes 2x keys.
- Alternative handles available (see page 234-235).

MFC **Veneer (3 Week Lead Time)**

DHP4/8L - 1000w x 800-600d x 740h _____

£710 £1,099

DHP4/8R - 1000w x 800-600d x 740h _____

£710 £1,099

- 4x Single Drawers

SDHP4/8L - 1000w x 800-600d x 740h _____

£780 £1,173

SDHP4/8R - 1000w x 800-600d x 740h _____

£780 £1,173

- 4x Single System Drawers

Personal Storage Desktop Storage

Lead Time: Standard (All products are manufactured to order and when 'Standard Lead Time' is quoted (7 – 10 days), this may vary dependant on volume ordered, factory capacity and distribution requirements at the time of ordering. For more information please contact your Dealer Business Manager or the Customer Services Team for clarification.)

Wood: Available in MFC (Ash, Autumn Cherry, Beech, Chester Oak, English Walnut, Grey, Grey Nebraska Oak, Laurentii Wenge, Natural Nebraska Oak and White)
Top Panel Edge Detail available on 25mm White MFC (Wenge and Black - Add £32 Retail Per Top) (Plywood - Add £42 Retail Per Top)
Available in Veneer (Oak and Walnut) on a 3 Week Lead Time



DHPSU/8

Open Fronted Pedestal-top Storage Unit

- 25mm top panel.
- Suitable for A4 lever arch filing.

DHPSU/8 - 418w x 800d x 375h

- Open Fronted

MFC

**Veneer
(3 Week
Lead Time)**

£232

£359



DHPSU/8STRH

Tambour Fronted Pedestal-top Storage Unit

- 25mm top panel.
- Suitable for A4 lever arch filing.
- 1x lockable side opening tambour door, includes 2x keys.
- Silver door only.
- Alternative handles available (see page 234-235).

DHPSU/8STLH - 418w x 800d x 375h

DHPSU/8STRH - 418w x 800d x 375h

- Tambour Fronted

MFC

**Veneer
(3 Week
Lead Time)**

£398

£561

£398

£561



DTO16

Desktop Organiser

- 25mm top panel.
- Complete with shelving.

DTO18 - 1800w x 300d x 355h

DTO16 - 1600w x 300d x 355h

DTO14 - 1400w x 300d x 355h

DTO12 - 1200w x 300d x 355h

- Open Fronted

MFC

**Veneer
(3 Week
Lead Time)**

£353

£548

£341

£530

£331

£510

£318

£491

Personal Storage Low Under Desk Storage and Accessories

Lead Time: Standard (All products are manufactured to order and when 'Standard Lead Time' is quoted (7 – 10 days), this may vary dependant on volume ordered, factory capacity and distribution requirements at the time of ordering. For more information please contact your Dealer Business Manager or the Customer Services Team for clarification.)

Wood: Available in MFC (Ash, Autumn Cherry, Beech, Chester Oak, English Walnut, Grey, Grey Nebraska Oak, Laurentii Wenge, Natural Nebraska Oak and White)
Available in Veneer (Oak and Walnut) on a 3 Week Lead Time

Fabric: Group 1-7



MPP2DLH



MPP2DLH/SP

2 Drawer Single Sided Mobile Personal Storage Unit

- 18mm top panel. • Suitable for 1x row of A4 ringbinders.
- Complete with 1x adjustable shelf. • Lockable, includes 2x keys.
- Alternative handles available (see page 234-235).

MPP2DLH - 1000w x 600d x 570h _____

MPP2DRH - 1000w x 600d x 570h _____

- 1x Single and 1x Filing Drawer

MPP2DLH/SP - 1000w x 600d x 632h _____

- 1x Single and 1x Filing Drawer • Supplied with Seat Pad

MPP2DRH/SP - 1000w x 600d x 632h _____

- 1x Single and 1x Filing Drawer • Supplied with Seat Pad

	MFC	Veneer (3 Week Lead Time)
MPP2DLH	£785	£1,138
MPP2DRH	£785	£1,138

Group 1	£891	£1,243
Group 2	£907	£1,259
Group 3	£923	£1,275
Group 4	£941	£1,293
Group 5	£958	£1,310
Group 6	£978	£1,330
Group 7	£1,024	£1,376



MPP3DLH



MPP3DLH/SP

3 Drawer Single Sided Mobile Personal Storage Unit

- 18mm top panel. • Suitable for 1x row of A4 ringbinders.
- Complete with 1x adjustable shelf. • Lockable, includes 2x keys.
- Alternative handles available (see page 234-235).

MPP3DLH - 1000w x 600d x 570h _____

MPP3DRH - 1000w x 600d x 570h _____

- 3x Single Drawers

MPP3DLH/SP - 1000w x 600d x 632h _____

- 3x Single Drawers • Supplied with Seat Pad

MPP3DRH/SP - 1000w x 600d x 632h _____

- 3x Single Drawers • Supplied with Seat Pad

	MFC	Veneer (3 Week Lead Time)
MPP3DLH	£785	£1,138
MPP3DRH	£785	£1,138

Group 1	£891	£1,243
Group 2	£907	£1,259
Group 3	£923	£1,275
Group 4	£941	£1,293
Group 5	£958	£1,310
Group 6	£978	£1,330
Group 7	£1,024	£1,376



PT

Pen and Stationery Tray

- Black plastic overlay tray. • Comprises of 6x compartments.
- For use with 418mm wide pedestals.

PT - 335w x175d x 30h _____

- For Standard Pedestals

SPT - 360w x175d x 30h _____

- For System Pedestals

Price

£29

£29



SDDK

Drawer Divider Kit

- Kit comprises of 2x cross dividers, 2x small lateral dividers, 2x medium lateral dividers and 2x large lateral dividers.

SDDK _____

- For System Pedestals

Price

£33

Personal Storage Low Under Desk and Desk High Storage

Lead Time: Standard (All products are manufactured to order and when 'Standard Lead Time' is quoted (7 – 10 days), this may vary dependant on volume ordered, factory capacity and distribution requirements at the time of ordering. For more information please contact your Dealer Business Manager or the Customer Services Team for clarification.)

Wood: Available in MFC (Ash, Autumn Cherry, Beech, Chester Oak, English Walnut, Grey, Grey Nebraska Oak, Laurentii Wenge, Natural Nebraska Oak and White)
Top Panel Edge Detail available on 25mm White MFC (Wenge and Black - Add £32 Retail Per Top) (Plywood - Add £42 Retail Per Top)
Available in Veneer (Oak and Walnut) on a 3 Week Lead Time

Fabric: Group 1-7



SLSU



SLSU/SP

Single Sided Mobile Storage Unit

- 25mm top panel. • Suitable for 1x row of A4 ringbinders.
- Complete with 1x adjustable shelf. • Optional seat pad is 62mm from top of the unit.
- Optional seat pad is supplied with self adhesive pads.

SLSU - 1000w x 400d x 630h _____

- Open Fronted

SLSU/SP - 1000w x 400d x 692h _____

- Open Fronted • Supplied with Seat Pad

MFC **Veneer (3 Week Lead Time)**

£550	£859
£653	£960
£669	£976
£685	£992
£703	£1,010
£720	£1,027
£740	£1,047
£785	£1,093

Group 1
Group 2
Group 3
Group 4
Group 5
Group 6
Group 7

Double Sided Mobile Storage Unit

- 25mm top panel. • Suitable for 1x row of A4 ringbinders (1x each side).
- Complete with 2x adjustable shelves (1x each side).
- Optional seat pad is 62mm from top of the unit.
- Optional seat pad is supplied with self adhesive pads.

DLSU - 1000w x 600d x 630h _____

- Open Fronted

DLSU/SP - 1000w x 600d x 692h _____

- Open Fronted • Supplied with Seat Pad

MFC **Veneer (3 Week Lead Time)**

£642	£996
£747	£1,102
£763	£1,118
£779	£1,134
£797	£1,152
£814	£1,169
£834	£1,189
£880	£1,235

Group 1
Group 2
Group 3
Group 4
Group 5
Group 6
Group 7



DLSU



DLSU/SP

Single Sided Desk High Mobile Storage Unit

- 25mm top panel. • Suitable for 1x row of A4 ringbinders.
- Complete with 1x adjustable shelf.

SHSU - 1000w x 400d x 740h _____

SHSU/8 - 800w x 400d x 740h _____

- Open Fronted

MFC **Veneer (3 Week Lead Time)**

£582	£902
£469	£787



SHSU

Double Sided Desk High Mobile Storage Unit

- 25mm top panel. • Suitable for 1x row of A4 ringbinders (1x each side).
- Complete with 2x adjustable shelves (1x each side).

DHSU - 1000w x 600d x 740h _____

DHSU/8 - 800w x 600d x 740h _____

- Open Fronted

MFC **Veneer (3 Week Lead Time)**

£673	£1,042
£561	£925



DHSU

Pedestals and Personal Storage Accessories

Lead Time: Standard (All products are manufactured to order and when 'Standard Lead Time' is quoted (7 – 10 days), this may vary dependant on volume ordered, factory capacity and distribution requirements at the time of ordering. For more information please contact your Dealer Business Manager or the Customer Services Team for clarification.)

Metalwork: Available in Silver RAL 9006 (Standard), Black Graphite RAL 9004 and White RAL 9003



Standard Metal Handle

• 160mm centres. • Supplied as standard on all items requiring handles.

Metalwork

Silver RAL 9006	-	168w x 10d x 25h	_____	£0
Black Graphite RAL 9004	-	168w x 10d x 25h	_____	£0
White RAL 9003	-	168w x 10d x 25h	_____	£0



Metal Handle

• 160mm centres.

Metalwork

STD	-	Silver RAL 9006	-	168w x 10d x 25h	_____	£5
STD/BG	-	Black Graphite RAL 9004	-	168w x 10d x 25h	_____	£5
STD/W	-	White RAL 9003	-	168w x 10d x 25h	_____	£5



Pedestals and Personal Storage Accessories

Lead Time: Standard (All products are manufactured to order and when 'Standard Lead Time' is quoted (7 – 10 days), this may vary dependant on volume ordered, factory capacity and distribution requirements at the time of ordering. For more information please contact your Dealer Business Manager or the Customer Services Team for clarification.)

Metalwork: Available in Silver RAL 9006 (Standard), Black Graphite RAL 9004 and White RAL 9003



Metal Flush Handle

- 160mm centres.

Metalwork

HAN/FLU	- Silver RAL 9006	- 200w x 13d x 19h	_____	£5
HAN/FLU/BG	- Black Graphite RAL 9004	- 200w x 13d x 19h	_____	£5
HAN/FLU/W	- White RAL 9003	- 200w x 13d x 19h	_____	£5



BRG

Metal Bridge Handle

- 128mm centres. • Not retrofittable.

Metalwork

BRG	- Silver RAL 9006	- 140w x 10d x 25h	_____	£5
BRG/BG	- Black Graphite RAL 9004	- 140w x 10d x 25h	_____	£5
BRG/W	- White RAL 9003	- 140w x 10d x 25h	_____	£5



CAM

Metal Camber Handle

- 128mm centres. • Not retrofittable.

Metalwork

CAM	- Silver RAL 9006	- 155w x 5d x 25h	_____	£5
CAM/BG	- Black Graphite RAL 9004	- 155w x 5d x 25h	_____	£5
CAM/W	- White RAL 9003	- 155w x 5d x 25h	_____	£5



BAR

Metal T-Bar Handle

- 128mm centres. • Not retrofittable.

Metalwork

BAR	- Silver RAL 9006	- 168w x 10d x 34h	_____	£5
BAR/BG	- Black Graphite RAL 9004	- 168w x 10d x 34h	_____	£5
BAR/W	- White RAL 9003	- 168w x 10d x 34h	_____	£5



SLB

Metal Slab Handle

- 128mm centres. • Not retrofittable.

Metalwork

SLB	- Silver RAL 9006	- 188w x 10d x 30h	_____	£5
SLB/BG	- Black Graphite RAL 9004	- 188w x 10d x 30h	_____	£5
SLB/W	- White RAL 9003	- 188w x 10d x 30h	_____	£5



BOW

Metal Bow Handle

- 128mm centres. • Not retrofittable.

Metalwork

BOW	- Silver RAL 9006	- 160w x 8d x 26h	_____	£5
BOW/BG	- Black Graphite RAL 9004	- 160w x 8d x 26h	_____	£5
BOW/W	- White RAL 9003	- 160w x 8d x 26h	_____	£5

Storage



Elite's extensive storage options are specifically designed to complement the various desking ranges within our portfolio. A variety of heights and widths combine perfectly with open fronted, wooden door and side opening tambour door options. Storage units are very easily configured and designed to function with different styles of accessory options. System internals are available to personalise storage and meet filing demand and expectation. A range of lockers with mobile hand-held storage devices promote flexible working and are ideal for non-fixed workplace environments. Our storage portfolio also incorporates a unit capable of controlling recycling efforts, with 2 or 3 segments to separate different recycling materials. Cubeform is our latest introduction which hosts a family of storage and informal tables solutions. Easily configured with multiple internals, the storage system can flawlessly interject any space creating designated areas or act alone to fulfil any storage needs.

Storage Flare Boardroom Storage Units

Lead Time: Standard (All products are manufactured to order and when 'Standard Lead Time' is quoted (7 – 10 days), this may vary dependant on volume ordered, factory capacity and distribution requirements at the time of ordering. For more information please contact your Dealer Business Manager or the Customer Services Team for clarification.)

Wood: Available in MFC (Ash, Autumn Cherry, Beech, Chester Oak, English Walnut, Grey, Grey Nebraska Oak, Laurentii Wenge, Natural Nebraska Oak and White)
Top Panel Edge Detail available on 25mm White MFC (Wenge and Black - Add £32 Retail Per Top) (Plywood - Add £42 Retail Per Top)
Available in Nanotech (Black)
Available in Veneer (Oak and Walnut) on a 3 Week Lead Time
Specific items also available in Coloured MFC (Paraline, Petrol, Red, Sea Blue, Turquoise and Yellow)

Metalwork: Available in the finishes detailed below

Flare Boardroom Storage Unit

- 25mm top panel. • 2 / 3 / 4x hinged doors. • Lockable, includes 2x keys.
- All units supplied with 1 piece top and bottom.
- Contrasting doors available on MFC and Black Nanotech only.
- Alternative handles available (see page 234-235).
- Additional shelves available (see page 238).



FLA7/5/D4



FLA7/5/D3



FLA7/5/D2

				MFC	Black Nanotech	Veneer (3 Week Lead Time)
FLA7/6/D4...	- 4 Doors	- 2x Adjustable Shelves	- 2000w x 600d x 740h	£1,277	£1,819	£1,885
FLA7/5/D4...	- 4 Doors	- 2x Adjustable Shelves	- 2000w x 500d x 740h	£1,199	£1,674	£1,760
FLA7/6/D3...	- 3 Doors	- 2x Adjustable Shelves	- 1500w x 600d x 740h	£1,024	£1,429	£1,490
FLA7/5/D3...	- 3 Doors	- 2x Adjustable Shelves	- 1500w x 500d x 740h	£962	£1,324	£1,393
FLA7/6/D2...	- 2 Doors	- 1x Adjustable Shelf	- 1000w x 600d x 740h	£739	£1,038	£1,049
FLA7/5/D2...	- 2 Doors	- 1x Adjustable Shelf	- 1000w x 500d x 740h	£699	£966	£986

- Silver (.../SF) as Standard
- Add £0 for Black Graphite (.../BGF) or White (.../WF)
- Add £20 for Raw Metalwork (.../RF)
- Add £48 for Black (.../BF), Blue (.../BUF), Coral (.../CRF), Green (.../GNF), Light Grey (.../LGF), Teal (.../TLF) or Yellow (.../YEF)
- Add £69 for Chrome Effect (.../CF)

- Add £0 (on MFC) or £0 (on Black Nanotech) per door for Standard MFC Contrasting Door Finish (.../CON)
 - Add £24 (on MFC) or £0 (on Black Nanotech) per door for Coloured MFC Contrasting Door Finish (.../CON)
 - Add £27 (on MFC) or £0 (on Black Nanotech) per door for Black Nanotech Contrasting Door Finish (.../CON)
- Further information required, contact Customer Services for a specification form.

- For Fridge Cut-Out on 600d only, add £90 per Cut-Out and suffix FDG codes (see page 239)



Storage Combined Storage Units

Lead Time: Standard (All products are manufactured to order and when 'Standard Lead Time' is quoted (7 – 10 days), this may vary dependant on volume ordered, factory capacity and distribution requirements at the time of ordering. For more information please contact your Dealer Business Manager or the Customer Services Team for clarification.)

Wood: Available in MFC (Ash, Autumn Cherry, Beech, Chester Oak, English Walnut, Grey, Grey Nebraska Oak, Laurentii Wenge, Natural Nebraska Oak and White)
Top Panel Edge Detail available on 25mm White MFC (Wenge and Black - Add £32 Retail Per Top) (Plywood - Add £42 Retail Per Top)
Available in Nanotech (Black)
Available in Veneer (Oak and Walnut) on a 3 Week Lead Time
Specific items also available in Coloured MFC (Paraline, Petrol, Red, Sea Blue, Turquoise and Yellow)

Combined Storage Unit

- 25mm top panel. • 2/3/4x hinged doors. • Lockable, includes 2x keys.
- 1000w and 1500w units supplied with 1 piece top and bottom.
- 2000w units supplied with 1 piece top and 2 piece bottom.
- Contrasting doors available on MFC and Black Nanotech only.
- Alternative handles available (see page 234-235).
- Additional shelves available (see below).



CSU7/5/D4



CSU7/5/D3



CSU7/5/D2

	MFC	Black Nanotech	Veneer (3 Week Lead Time)
CSU7/6/D4 - 4 Doors - 2x Adjustable Shelves - 2000w x 600d x 740h	£1,106	£1,647	£1,712
CSU7/5/D4 - 4 Doors - 2x Adjustable Shelves - 2000w x 500d x 740h	£1,027	£1,502	£1,588
CSU7/6/D3 - 3 Doors - 2x Adjustable Shelves - 1500w x 600d x 740h	£851	£1,257	£1,318
CSU7/5/D3 - 3 Doors - 2x Adjustable Shelves - 1500w x 500d x 740h	£791	£1,152	£1,221
CSU7/6/D2 - 2 Doors - 1x Adjustable Shelf - 1000w x 600d x 740h	£567	£866	£878
CSU7/5/D2 - 2 Doors - 1x Adjustable Shelf - 1000w x 500d x 740h	£527	£793	£813

- Add £0 (on MFC) or £0 (on Black Nanotech) per door for Standard MFC Contrasting Door Finish (.../CON)
 - Add £24 (on MFC) or £0 (on Black Nanotech) per door for Coloured MFC Contrasting Door Finish (.../CON)
 - Add £27 (on MFC) or £0 (on Black Nanotech) per door for Nanotech MDF Contrasting Door Finish (.../CON)
- Further information required, contact Customer Services for a specification form.

- For Fridge Cut-Out on 600d only, add £90 per Cut-Out and suffix FDG codes below

Flare Boardroom and Combined Storage Unit Cut-Out for Fridge

- Applies a cut-out to the chosen back section of the 600d unit only and extra panels are added to divide the remaining internal space.
- To apply a fridge cut-out to the 600d Flare Boardroom and Combined Storage Units, suffix .../FDG to your chosen unit and refer to the '123' guide below. • Section numbers always start from left-hand section.

	Price
.../FDG1 - Cut-Out in Section 1 on 2, 3 and 4 Door Units	£90
.../FDG2 - Cut-Out in Section 2 on 2, 3 and 4 Door Units	£90
.../FDG3 - Cut-Out in Section 3 on 4 Door Units	£90
.../FDG4 - Cut-Out in Section 4 on 4 Door Units	£90



- 1 Section 1
- 2 Section 2
- 3 Section 3
- 4 Section 4

Flare Boardroom and Combined Storage Unit Adjustable Shelves



CSU/5/S/D2

	MFC	Black Nanotech	Veneer (3 Week Lead Time)
CSU/5/S/D1 - For Single Section 3 Door 500d Units - 472w x 408d x 18h	£22	£32	£34
CSU/5/S/D2 - For 2 / 4 Door 500d Units - 963w x 408d x 18h	£41	£61	£67
CSU/5/S/D3 - For Double Section 3 Door 500d Units - 972w x 408d x 18h	£41	£61	£67
CSU/6/S/D1 - For Single Section 3 Door 600d Units - 472w x 508d x 18h	£24	£34	£36
CSU/6/S/D2 - For 2 / 4 Door 600d Units - 963w x 508d x 18h	£48	£67	£71
CSU/6/S/D3 - For Double Section 3 Door 600d Units - 972w x 508d x 18h	£48	£67	£71

Storage Desk High Storage

Lead Time: Standard (All products are manufactured to order and when 'Standard Lead Time' is quoted (7 – 10 days), this may vary dependant on volume ordered, factory capacity and distribution requirements at the time of ordering. For more information please contact your Dealer Business Manager or the Customer Services Team for clarification.)

Wood: Available in MFC (Ash, Autumn Cherry, Beech, Chester Oak, English Walnut, Grey, Grey Nebraska Oak, Laurentii Wenge, Natural Nebraska Oak and White)
Top Panel Edge Detail available on 25mm White MFC (Wenge and Black - Add £32 Retail Per Top) (Plywood - Add £42 Retail Per Top)
Available in Veneer (Oak and Walnut) on a 3 Week Lead Time



NSU12/5

Desk High Storage Unit

- 25mm top panel. • 2x sliding doors. • 1600mm wide units with centre partition.
- Lockable, includes 2x keys. • Alternative handles available (see page 234-235).

		MFC	Veneer (3 Week Lead Time)
NSU16/6	- 2x Adjustable Shelves - 1600w x 600d x 740h	£859	£1,332
NSU12/6	- 1x Adjustable Shelf - 1200w x 600d x 740h	£706	£1,093
NSU8/6	- 1x Adjustable Shelf - 800w x 600d x 740h	£557	£862
NSU16/5	- 2x Adjustable Shelves - 1600w x 500d x 740h	£783	£1,217
NSU12/5	- 1x Adjustable Shelf - 1200w x 500d x 740h	£642	£995
NSU8/5	- 1x Adjustable Shelf - 800w x 500d x 740h	£501	£779
NSU16/4	- 2x Adjustable Shelves - 1600w x 400d x 740h	£710	£1,138
NSU12/4	- 1x Adjustable Shelf - 1200w x 400d x 740h	£583	£939
NSU8/4	- 1x Adjustable Shelf - 800w x 400d x 740h	£452	£748



NSUJ12/6

Desk High Credenza Storage Unit

- 25mm top panel. • 2x sliding doors.
- Ventilated on the left-hand side to accept NDS600 mini bar fridge (see below).
- Lockable, includes 2x keys. • Alternative handles available (see page 234-235).

		MFC	Veneer (3 Week Lead Time)
NSUZ16/6	- 1x Adjustable Shelf - 1600w x 600d x 740h	£859	£1,332
NSUZ12/6	- 1x Adjustable Shelf - 1200w x 600d x 740h	£706	£1,093



NDS600

Mini Bar Fridge

- 1.6 cu.ft / 46 litre capacity. • Energy rating of "A+". • Sleek gloss white frame.
- Includes 1x shelf and a bottle rack. • Noise level of 41 db (A).
- 1 year manufacturers warranty (must register with manufacturer upon purchase).

		Price
NDS600	- 472w x 450d x 492h	£276



NOSU12/5

Open Fronted Desk High Storage Unit

- 25mm top panel.

		MFC	Veneer (3 Week Lead Time)
NOSU12/6	- 1x Adjustable Shelf - 1200w x 600d x 740h	£588	£916
NOSU12/5	- 1x Adjustable Shelf - 1200w x 500d x 740h	£536	£831
NOSU12/4	- 1x Adjustable Shelf - 1200w x 400d x 740h	£478	£741



NSF2/6

Side Filing Unit

- 25mm top panel. • 2x filing drawers with built in anti-tilt mechanism. • Foolsap filing.
- Lockable, includes 2x keys. • Alternative handles available (see page 234-235).

		MFC	Veneer (3 Week Lead Time)
NSF2/6	- 800w x 600d x 740h	£807	£1,248
NSF2/5	- 800w x 500d x 740h	£765	£1,186



NSF2/6RH

Side Filing Unit with Overhanging Top

- 25mm top panel. • 220mm overhang. • 2x filing drawers with built in anti-tilt mechanism.
- Foolsap filing. • Lockable, includes 2x keys.
- Alternative handles available (see page 234-235).
- Optional CPU Holder available (see page 326).

		MFC	Veneer (3 Week Lead Time)
NSF2/6LH	- 1020w x 600d x 740h	£809	£1,272
NSF2/6RH	- 1020w x 600d x 740h	£809	£1,272

Storage Desk High Storage, Desktop Storage and Plan Chests

Lead Time: Standard (All products are manufactured to order and when 'Standard Lead Time' is quoted (7 – 10 days), this may vary dependant on volume ordered, factory capacity and distribution requirements at the time of ordering. For more information please contact your Dealer Business Manager or the Customer Services Team for clarification.)

Wood: Available in MFC (Ash, Autumn Cherry, Beech, Chester Oak, English Walnut, Grey, Grey Nebraska Oak, Laurentii Wenge, Natural Nebraska Oak and White)
Top Panel Edge Detail available on 25mm White MFC (Wenge and Black - Add £32 Retail Per Top) (Plywood - Add £42 Retail Per Top)
Available in Veneer (Oak and Walnut) on a 3 Week Lead Time



NSSC10

Storage Unit

- 25mm top panel.
- 2x hinged doors.
- Lockable, includes 2x keys.
- Alternative handles available (see page 234-235).

NSSC10 - 1x Adjustable Shelf - 1060w x 500d x 740h		MFC	Veneer (3 Week Lead Time)
		£647	£996



TCGH

Glass Fronted Desktop Storage Unit with Hinged Doors

- 25mm top panel.
- 2x 4mm toughened glass hinged doors.
- Lockable, includes 2x keys.
- Alternative handles available (see page 234-235).
- Suitable for NSSC10 (see above).

TCGH - 1x Adjustable Shelf - 1060w x 330d x 875h		MFC	Veneer (3 Week Lead Time)
		£667	£1,030



TC12

Open Fronted Desktop Storage Unit

- 25mm top panel.

TC12 - 1x Adjustable Shelf - 1200w x 350d x 725h		MFC	Veneer (3 Week Lead Time)
TC8 - 1x Adjustable Shelf - 800w x 350d x 725h		£356	£558
		£278	£427



PC8A0

A0 Plan Chest

- 25mm top panel.
- Available with 8x, 6x, 3x or 1x drawers.
- Will accommodate paper size A0 (1189mm x 841mm).
- 18mm top.
- Alternative handles available (see page 234-235).

PC8A0 - 8x Drawers - 1340w x 960d x 830h		MFC	Veneer (3 Week Lead Time)
PC6A0 - 6x Drawers - 1340w x 960d x 830h			£1,169
PC3A0 - 3x Drawers - 1340w x 960d x 830h			£896
PC1A0 - 1x Drawer - 1340w x 960d x 830h			£588
			£518



PC8A1

A1 Plan Chest

- 25mm top panel.
- Available with 8x, 6x, 3x or 1x drawers.
- Will accommodate paper size A1 (841mm x 594mm).
- 18mm top.
- Alternative handles available (see page 234-235).

PC8A1 - 8x Drawers - 992w x 707d x 830h		MFC	Veneer (3 Week Lead Time)
PC6A1 - 6x Drawers - 992w x 707d x 830h			£855
PC3A1 - 3x Drawers - 992w x 707d x 830h			£653
PC1A1 - 1x Drawer - 992w x 707d x 830h			£491
			£446

Storage Planter Storage Unit and Storage Planter Boxes

Lead Time: Standard (All products are manufactured to order and when 'Standard Lead Time' is quoted (7 – 10 days), this may vary dependant on volume ordered, factory capacity and distribution requirements at the time of ordering. For more information please contact your Dealer Business Manager or the Customer Services Team for clarification.)

Wood: Available in MFC (Ash, Autumn Cherry, Beech, Chester Oak, English Walnut, Grey, Grey Nebraska Oak, Laurentii Wenge, Natural Nebraska Oak and White)
Top Panel Edge Detail available on 25mm White MFC (Wenge and Black - Add £32 Retail Per Top) (Plywood - Add £42 Retail Per Top)



NSU8/4/P

Planter Storage Unit

- 25mm top panel. • 2x sliding doors. • Open display shelf.
- Recessed planter bed within top section of the storage unit.
- Lockable, includes 2x keys. • Alternative handles available (see page 234-235).
- 764w x 356d x 174h internal dimensions. • This unit is supplied without plants, plant tray or liner.
- The units require a waterproof membrane liner to protect against moisture and water ingress.

MFC

NSU8/4/P - 1x Adjustable Shelf - 800w x 400d x 1266h | £829



SPB12/6

Storage Planter Boxes

- 25mm top panel. • Retro-fittable planter bed. • Internal dimensions are w-36 x d-36 x h-18.
- This unit is supplied without plants, plant tray or liner.
- The units require a waterproof membrane liner to protect against moisture and water ingress.

MFC

SPB16/6 - For use with NSU16/6 - 1600w x 600d x 170h | £406
SPB12/6 - For use with NSU12/6 - 1200w x 600d x 170h | £346
SPB8/6 - For use with NSU8/6 - 800w x 600d x 170h | £286



SPB12/5

SPB16/5 - For use with NSU16/5 and NML/TB4 - 1600w x 500d x 170h | £382
SPB12/5 - For use with NSU12/5 and NML/TB3 - 1200w x 500d x 170h | £322
SPB8/5 - For use with NSU8/5 and NML/TB2 - 800w x 500d x 170h | £263
SPB4/5 - For use with NML/TB1 - 400w x 500d x 170h | £204

SPB16/4 - For use with NSU16/4 - 1600w x 400d x 170h | £357
SPB12/4 - For use with NSU12/4 - 1200w x 400d x 170h | £298
SPB8/4 - For use with NSU8/4 and SC7 - 800w x 400d x 170h | £239

SPB105/5 - For use with NSSC Tambours - 1050w x 500d x 170h | £298

SPB99/5 - For use with NSSC Cupboards - 990w x 500d x 170h | £298



SPB8/4



SPB105/5



SPB99/5



Storage Desk High Storage

Lead Time: Standard (All products are manufactured to order and when 'Standard Lead Time' is quoted (7 – 10 days), this may vary dependant on volume ordered, factory capacity and distribution requirements at the time of ordering. For more information please contact your Dealer Business Manager or the Customer Services Team for clarification.)

Wood: Available in MFC (Ash, Autumn Cherry, Beech, Chester Oak, English Walnut, Grey, Grey Nebraska Oak, Laurentii Wenge, Natural Nebraska Oak and White)
 Top Panel Edge Detail available on 25mm White MFC (Wenge and Black - Add £32 Retail Per Top) (Plywood - Add £42 Retail Per Top)
 Available in Veneer (Oak and Walnut) on a 3 Week Lead Time



OSUD16/6

Desk High Combi Storage Unit

- 25mm top panel.
- Combination unit comprising of 2x 4 drawer units and open fronted storage.
- Lockable, includes 2x keys. • Alternative handles available (see page 234-235).

OSUD16/6 - 1x Adjustable Shelf - 1600w x 600d x 740h		MFC	Veneer (3 Week Lead Time)
• 2x 4x Single Drawers		£1,256	£1,948



SU8X8

90 Degree Desk High Storage Unit

- 25mm top panel. • Open fronted. • Accepts 2x rows of A4 ring binders.

SU8X8 - 1x Shelf - 800w x 800d x 740h		MFC	Veneer (3 Week Lead Time)
SU6X6 - 1x Shelf - 600w x 600d x 740h		£464	£711
		£417	£648



SU8X8ST

90 Degree Desk High Tambour Storage Unit

- 25mm top panel. • 2x side opening tambour doors. • Accepts 2x rows of A4 ring binders.
- Alternative handles available (see page 234-235).

SU8X8ST - Silver Blinds - 1x Shelf - 800w x 800d x 740h		MFC	Veneer (3 Week Lead Time)
SU8X8ST/W - White Blinds - 1x Shelf - 800w x 800d x 740h		£583	£902
		£583	£902



Storage Filing Cabinets, Bookcases and Storage Units

Lead Time: Standard (All products are manufactured to order and when 'Standard Lead Time' is quoted (7 – 10 days), this may vary dependant on volume ordered, factory capacity and distribution requirements at the time of ordering. For more information please contact your Dealer Business Manager or the Customer Services Team for clarification.)

Wood: Available in MFC (Ash, Autumn Cherry, Beech, Chester Oak, English Walnut, Grey, Grey Nebraska Oak, Laurentii Wenge, Natural Nebraska Oak and White)
Top Panel Edge Detail available on 25mm White MFC (Wenge and Black - Add £32 Retail Per Top) (Plywood - Add £42 Retail Per Top)
Available in Veneer (Oak and Walnut) on a 3 Week Lead Time



FC2

2 Drawer Filing Cabinet

- 25mm top panel. • Central locking with anti-tilt mechanism. • Foolscape filing.
- Alternative handles available (see page 234-235).

FC2 - 466w x 600d x 740h
• 2x Filing Drawers

MFC	Veneer (3 Week Lead Time)
£413	£683



FC3

3 Drawer Filing Cabinet

- 25mm top panel. • Central locking with anti-tilt mechanism. • Foolscape filing.
- Alternative handles available (see page 234-235).

FC3 - 466w x 600d x 1069h
• 3x Filing Drawers

MFC	Veneer (3 Week Lead Time)
£519	£854



FC4

4 Drawer Filing Cabinet

- 25mm top panel. • Central locking with anti-tilt mechanism. • Foolscape filing.
- Alternative handles available (see page 234-235).

FC4 - 466w x 600d x 1398h
• 4x Filing Drawers

MFC	Veneer (3 Week Lead Time)
£616	£1,019



BS18

Bookcase

- 25mm top panel on 740h version. • 18mm top panel on all other versions.
- Delivered unassembled. • Additional shelves available (see below).

BS20 - 5x Adjustable Shelves	- 800w x 300d x 2000h	£469	£728
BS18 - 4x Adjustable Shelves	- 800w x 300d x 1800h	£383	£597
BS16 - 4x Adjustable Shelves	- 800w x 300d x 1600h	£366	£568
BS12 - 3x Adjustable Shelves	- 800w x 300d x 1200h	£341	£530
BS10 - 2x Adjustable Shelves	- 800w x 300d x 1000h	£281	£446
BS7 - 1x Adjustable Shelf	- 800w x 300d x 740h	£251	£395

MFC	Veneer (3 Week Lead Time)
£469	£728
£383	£597
£366	£568
£341	£530
£281	£446
£251	£395



SC18

Storage Unit

- 25mm top panel on 740h version. • 18mm top panel on all other versions.
- 400mm deep. • 2x hinged doors. • Lockable, includes 2x keys.
- Alternative handles available (see page 234-235).
- Additional shelves available (see below).

SC20 - 18mm Top	- 4x Adjustable Shelves	- 800w x 400d x 2000h	£766	£1,191
SC18 - 18mm Top	- 3x Adjustable Shelves	- 800w x 400d x 1800h	£690	£1,073
SC16 - 18mm Top	- 3x Adjustable Shelves	- 800w x 400d x 1600h	£616	£953
SC12 - 18mm Top	- 2x Adjustable Shelves	- 800w x 400d x 1200h	£538	£835
SC7 - 25mm Top	- 1x Adjustable Shelf	- 800w x 400d x 740h	£452	£699

MFC	Veneer (3 Week Lead Time)
£766	£1,191
£690	£1,073
£616	£953
£538	£835
£452	£699



SC7/S

Additional Adjustable Shelves

BS	- For Bookcases and SC12-SC20 Units	- 764w x 278d x 18h	£38	£61
SC7/S	- For SC7 Units	- 760w x 276d x 18h	£38	£61

MFC	Veneer (3 Week Lead Time)
£38	£61
£38	£61

Storage Storage Units and Accessories

Lead Time: Standard (All products are manufactured to order and when 'Standard Lead Time' is quoted (7 – 10 days), this may vary dependant on volume ordered, factory capacity and distribution requirements at the time of ordering. For more information please contact your Dealer Business Manager or the Customer Services Team for clarification.)

Wood: Available in MFC (Ash, Autumn Cherry, Beech, Chester Oak, English Walnut, Grey, Grey Nebraska Oak, Laurentii Wenge, Natural Nebraska Oak and White)
Top Panel Edge Detail available on 25mm White MFC (Wenge and Black - Add £32 Retail Per Top) (Plywood - Add £42 Retail Per Top)
Available in Veneer (Oak and Walnut) on a 3 Week Lead Time



NSSC18

System Storage Unit

- 25mm top panel. • 500mm and 600mm deep. • 2x hinged doors.
- Lockable, includes 2x keys. • Carcase only. • Alternative handles available (see page 234-235).
- Skins and fitted wardrobe kit available (see below).
- Additional shelves available (see below).

	MFC	Veneer (3 Week Lead Time)
NSSC20 - 990w x 500d x 2000h	£856	£1,322
NSSC18 - 990w x 500d x 1800h	£772	£1,196
NSSC16 - 990w x 500d x 1600h	£692	£1,080
NSSC12 - 990w x 500d x 1200h	£618	£958
NSSC7 - 990w x 500d x 740h	£542	£838
NSSC7/6 - 990w x 600d x 740h	£584	£904



NSSC

Additional Adjustable Shelves

	MFC	Veneer (3 Week Lead Time)
NSSC - For 500d NSSC Units - 950w x 408d x 18h	£41	£67
NSSC7/6S - For 600d NSSC7/6 Units - 950w x 500d x 18h	£48	£71



SSU/CR99/5

System Storage Unit Clothes Rail

- Complete with hanging rail and single shelf.
- Compatible with system storage units (see above).

	MFC	Veneer (3 Week Lead Time)
SSU/CR99/5 - 1x Clothes Rail and 1x Shelf - For NSSC20 and NSSC18 Units	£101	£126



NFWK18

System Storage Unit Fitted Wardrobe Kit

- Complete with hanging rail. • Compatible with system storage units (see above).

	MFC	Veneer (3 Week Lead Time)
NFWK20 - 4x Adjustable Shelves - For NSSC20 Units	£241	£369
NFWK18 - 4x Adjustable Shelves - For NSSC18 Units	£198	£307

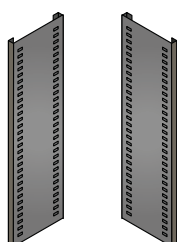

BTS18

System Storage Unit Skins

- Adapts system storage units (see above) to accept Elite internals.

	Price
BTS20 - For NSSC20 Units	£214
BTS18 - For NSSC18 Units	£207
BTS16 - For NSSC16 Units	£174
BTS12 - For NSSC12 Units	£152
BTS7 - For 740h NSSC Units	£131

Storage Tambour Storage Units

Lead Time: Standard (All products are manufactured to order and when 'Standard Lead Time' is quoted (7 – 10 days), this may vary dependant on volume ordered, factory capacity and distribution requirements at the time of ordering. For more information please contact your Dealer Business Manager or the Customer Services Team for clarification.)

Wood: Available in MFC (Ash, Autumn Cherry, Beech, Chester Oak, English Walnut, Grey, Grey Nebraska Oak, Laurentii Wenge, Natural Nebraska Oak and White)
Top Panel Edge Detail available on 25mm White MFC (Wenge and Black - Add £32 Retail Per Top) (Plywood - Add £42 Retail Per Top)
Available in Veneer (Oak and Walnut) on a 3 Week Lead Time



N SSC18ST



N SSC18ST/W

System Tambour Storage Unit

- 25mm top panel. • 500mm deep.
- 2x side opening silver or white blinds on tambour doors.
- Lockable, includes 2x keys. • Complete with system storage unit skins.
- Alternative handles available (see page 234-235).
- Additional shelves available (see below).

			MFC	Veneer (3 Week Lead Time)
N SSC20ST	- Silver Blinds	- 1050w x 500d x 2000h	£1,321	£1,685
N SSC18ST	- Silver Blinds	- 1050w x 500d x 1800h	£1,205	£1,558
N SSC16ST	- Silver Blinds	- 1050w x 500d x 1600h	£1,093	£1,417
N SSC12ST	- Silver Blinds	- 1050w x 500d x 1200h	£1,015	£1,318
N SSC7ST	- Silver Blinds	- 1050w x 500d x 740h	£863	£1,143
N SSC20ST/W	- White Blinds	- 1050w x 500d x 2000h	£1,321	£1,685
N SSC18ST/W	- White Blinds	- 1050w x 500d x 1800h	£1,205	£1,558
N SSC16ST/W	- White Blinds	- 1050w x 500d x 1600h	£1,093	£1,417
N SSC12ST/W	- White Blinds	- 1050w x 500d x 1200h	£1,015	£1,318
N SSC7ST/W	- White Blinds	- 1050w x 500d x 740h	£863	£1,143



N SSC7/6ST



N SSC7/6ST/W

System Tambour Storage Unit

- 25mm top panel. • 600mm deep.
- 2x side opening silver or white blinds on tambour doors.
- Lockable, includes 2x keys. • Complete with system storage unit skins.
- Alternative handles available (see page 234-235).
- Additional shelves available (see below).

			MFC	Veneer (3 Week Lead Time)
N SSC7/6ST	- Silver Blinds	- 1050w x 600d x 740h	£923	£1,227
N SSC7/6ST/W	- White Blinds	- 1050w x 600d x 740h	£923	£1,227



N SSC

Additional Adjustable Shelves

			MFC	Veneer (3 Week Lead Time)
N SSC	- For 500d N SSC Units	- 950w x 408d x 18h	£41	£67
N SSC7/6S	- For 600d N SSC7/6 Units	- 950w x 500d x 18h	£48	£71

Storage Accessories

Lead Time: Standard (All products are manufactured to order and when 'Standard Lead Time' is quoted (7 – 10 days), this may vary dependant on volume ordered, factory capacity and distribution requirements at the time of ordering. For more information please contact your Dealer Business Manager or the Customer Services Team for clarification.)



BIT10BSPS

Standard Shelf

- Single shelf.
- Requires system storage unit skins.

Price

BIT10BSPS _____ | £36



BIT10RSPS

Pull Out Reference Shelf

- Single shelf.
- Requires system storage unit skins.

Price

BIT10RSPS _____ | £119



BIT10SSPDPS - SHDV65P5PS

Slotted Filing Shelf with Dividers

- Single shelf.
- 5x dividers.
- Requires system storage unit skins.

Price

BIT10SSPDPS - Slotted Filing Shelf Only _____ | £56

SHDV65P5PS - 5x Dividers Only _____ | £56



BIT10LRPS

Lateral Filing Cradle

- Adjustable lateral filing cradle, between 190mm and 330mm centres.
- Requires system storage unit skins.

Price

BIT10LRPS _____ | £56



BIT10RFAPS

Pull Out Vertical Filing Cradle

- Complete with 2x cross bars to accept foolscap filing side on.
- Standard foolscap and A4 filing front to back.
- Requires system storage unit skins.

Price

BIT10RFAPS _____ | £138



BIT10RDAPS

Pull Out Vertical Drawer

- Drawer is 100mm deep.
- Requires system storage unit skins.

Price

BIT10RDAPS _____ | £179

Storage Vertical Capabilities Planning Guide

	Quantity of Vertical Rows A4 Box File - 265w x 75d x 337h	Quantity of Vertical Rows Foolscap Box File - 265w x 75d x 368h	Quantity of Vertical Rows A4 Lever Arch File - 280w x 75d x 318h	Quantity of Vertical Rows Foolscap Lever Arch File - 285w x 75d x 350h
Bookcase - BS20	5	4	5	4
Bookcase - BS18	4	4	4	4
Bookcase - BS16	4	3	4	3
Bookcase - BS12	2	2	3	2
Bookcase - BS10	2	2	2	2
Bookcase - BS7	1	1	1	1
Storage Unit - SC20	5	4	5	4
Storage Unit - SC18	4	4	4	4
Storage Unit - SC16	3	3	4	3
Storage Unit - SC12	2	2	3	2
Storage Unit - SC7	1	1	1	1
System Storage Unit - NSSC20	5	4	5	5
System Storage Unit - NSSC18	4	4	4	4
System Storage Unit - NSSC16	4	3	4	3
System Storage Unit - NSSC12	3	2	3	2
System Storage Unit - NSSC7 and NSSC7/6	1	1	1	1
System Tambour Storage Unit - NSSC20ST	5	4	5	5
System Tambour Storage Unit - NSSC18ST	4	4	4	4
System Tambour Storage Unit - NSSC16ST	4	3	4	4
System Tambour Storage Unit - NSSC12ST	3	2	3	2
System Tambour Storage Unit - NSSC7ST and NSSC7/6ST	1	1	1	1



Storage Cubeform



Storage Cubeform

How to Specify Cubeform

Vertical Frame

The code is for a Single Vertical Frame that is represented by a full uninterrupted orange vertical line. These Vertical Frames will be joined together when Bases and Shelves are specified.

Cubeforms specified 1 cube wide can be 1 or 2 cubes high only.

To create a configuration 2 cubes wide, 3 Vertical Frames are required, to create a configuration 3 cubes wide, 4 Vertical Frames are required, and so on.

These can be used on standard or corner configurations.

The Vertical Frames are represented in orange.

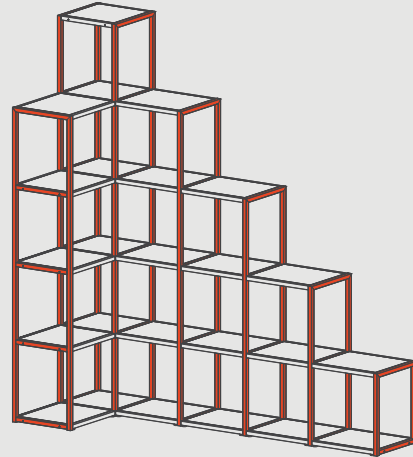

Base

The code is for the first shelf at floor level, represented by the uninterrupted orange horizontal line. The Bases connect the Vertical Frames together at the base of the unit.

Standard and Corner bases must be specified separately.

The Standard bases are represented in orange and the Corner bases are represented in blue.

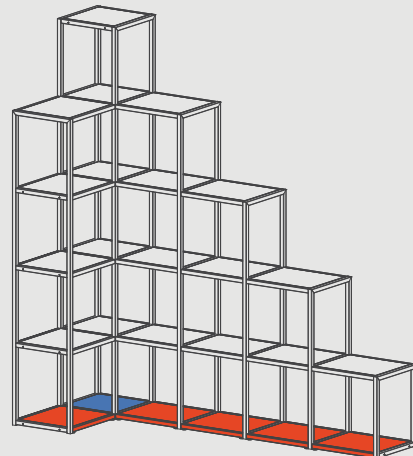

Shelf

The code is for all other shelves that are represented by the uninterrupted orange horizontal lines. The Shelves also connect the Vertical Frames together at regular intervals on the unit. These, along with the Bases, provide the structural link for the overall unit.

Standard and Corner shelves must be specified separately.

The Standard shelves are represented in orange and the Corner shelves are represented in blue.

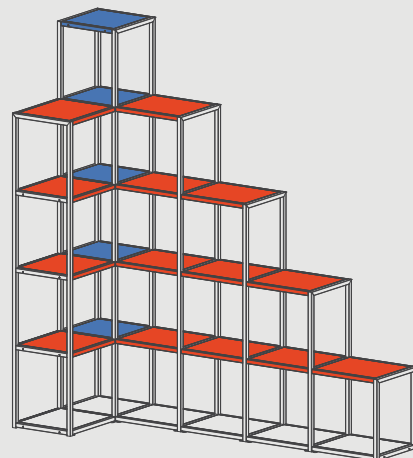

Accessories

A range of optional accessories are compatible with Cubeform delivering a number of flexible storage solutions.

All accessories can be retro-fitted.

Storage Cubeform

Lead Time: Standard (All products are manufactured to order and when 'Standard Lead Time' is quoted (7 – 10 days), this may vary dependant on volume ordered, factory capacity and distribution requirements at the time of ordering. For more information please contact your Dealer Business Manager or the Customer Services Team for clarification.)

Wood: Available in MFC (Ash, Autumn Cherry, Beech, Chester Oak, English Walnut, Grey, Grey Nebraska Oak, Laurentii Wenge, Natural Nebraska Oak and White)
Available in Nanotech (Black)

Metalwork: Available in Silver RAL 9006 (Standard), Black Graphite RAL 9004, White RAL 9003 and Raw finish (Add 5%)
Also available in Blue RAL 5001, Coral RAL 2001, Green RAL 6016, Light Grey RAL 7038, Teal RAL 5018 and Yellow RAL 1021 (Add 12% for all - 2 Week Lead Time)



CF/EFCC/BGR



CF/EFCC...

Cubeform End Frame Cover Caps

- Fills exposed flow drill holes on the ends of the framework.

CF/EFCC/S	- Silver	- Sold in Packs of 24	_____	£6
CF/EFCC/BGR	- Black Graphite	- Sold in Packs of 24	_____	£6
CF/EFCC/WH	- White	- Sold in Packs of 24	_____	£6

Price



CF/BC1



CF/BC2



CF/BC3



CF/BC4

Cubeform Bridging Cube

- 18mm top panels.
- Allows a connection between 2 tall Cubeform Structures.
- Uses a mixture of shelves and vertical frames to create the Bridging Cube.

CF/BC4	- 4 Sections Wide	- Creates 1775w x 875h Void	- 1775w x 400d x 475h	-	£853	£973
CF/BC3	- 3 Sections Wide	- Creates 1325w x 875h Void	- 1325w x 400d x 475h	-	£622	£712
CF/BC2	- 2 Sections Wide	- Creates 875w x 875h Void	- 875w x 400d x 475h	-	£391	£451
CF/BC1	- 1 Section Wide	- Creates 425w x 875h Void	- 425w x 400d x 475h	-	£160	£190

MFC

Black Nanotech

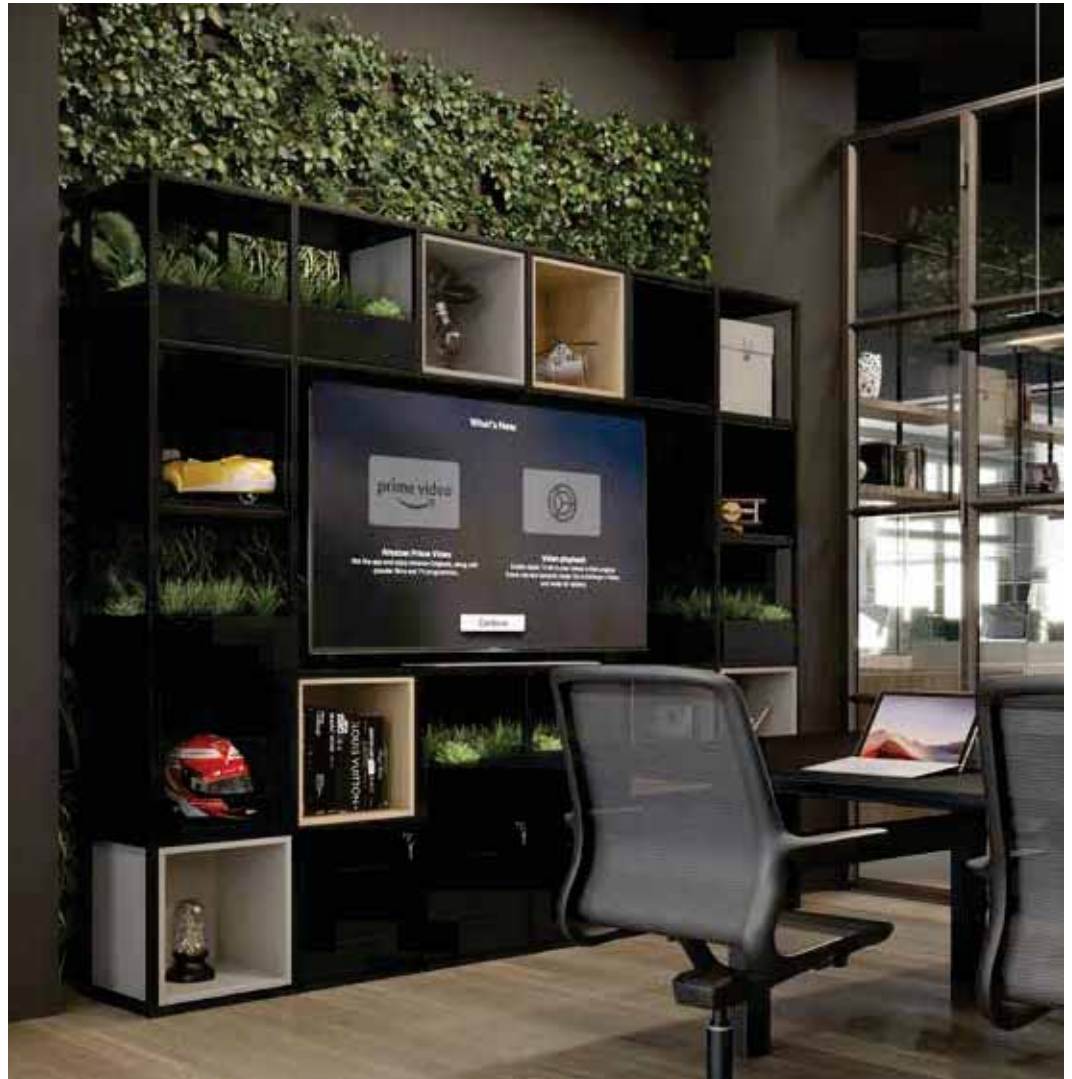

Storage Cubeform

Lead Time: Standard (All products are manufactured to order and when 'Standard Lead Time' is quoted (7 – 10 days), this may vary dependant on volume ordered, factory capacity and distribution requirements at the time of ordering. For more information please contact your Dealer Business Manager or the Customer Services Team for clarification.)

Wood: Available in MFC (Ash, Autumn Cherry, Beech, Chester Oak, English Walnut, Grey, Grey Nebraska Oak, Laurentii Wenge, Natural Nebraska Oak and White) Specific items also available in Coloured MFC (Paraline, Petrol, Red, Sea Blue, Turquoise and Yellow) Available in Nanotech (Black)

Metalwork: Available in Silver RAL 9006 (Standard), Black Graphite RAL 9004, White RAL 9003 and Raw finish (Add 5%) Also available in Blue RAL 5001, Coral RAL 2001, Green RAL 6016, Light Grey RAL 7038, Teal RAL 5018 and Yellow RAL 1021 (Add 12% for all - 2 Week Lead Time)

Fabric: Group 1-7



CF/SPB

Cubeform Single Planter Box

- 18mm top panel. • Planter boxes can be used on standard shelves only (not corner shelves).
- 389w x 364d x 152h internal dimensions.
- This unit is supplied without plants, plant tray or liner.
- The units require a waterproof membrane liner to protect against moisture and water ingress.
- For coloured MFC finishes, see 'Coloured MFC' price and suffix .../CON (see page 255).

	MFC	Coloured MFC	Black Nanotech
CF/SPB - Single Planter Box - 425w x 400d x 170h	£179	£225	£218



CF/SPB/PLT1

Plants for Cubeform Single Planter Box

- Plants to be used for Cubeform Single Planter Boxes.

	Price
CF/SPB/PLT1 - Plants for Single Planter Box	£625



CF/DPB

Cubeform Double Planter Box

- 18mm top panel. • Planter boxes can be used on standard shelves only (not corner shelves).
- Double Planter Boxes require space 2 shelves.
- 839w x 314d x 152h internal dimensions.
- This unit is supplied without plants, plant tray or liner.
- The units require a waterproof membrane liner to protect against moisture and water ingress.
- For coloured MFC finishes, see 'Coloured MFC' price and suffix .../CON (see page 255).

	MFC	Coloured MFC	Black Nanotech
CF/DPB - Double Planter Box - 875w x 350d x 170h	£239	£298	£292



CF/DPB/PLT1

Plants for Cubeform Double Planter Box

- Plants to be used for Cubeform Double Planter Boxes.

	Price
CF/DPB/PLT1 - Double Planter Box	£805



CF/OFB

Cubeform Open Fronted Box

- 18mm top panel. • Can be specified on standard shelves only (not corner shelves).
- Available with Standard, Whiteboard or Fabric back (see page 255).

	MFC	Black Nanotech
CF/OFB - Standard Back - 425w x 400d x 425h	£209	£281
CF/OFB/WB - Whiteboard Back - 425w x 400d x 425h	£286	£358
CF/OFB/FB - Fabric Back - 425w x 400d x 425h	Group 1	£358
	Group 2	£364
	Group 3	£370
	Group 4	£375
	Group 5	£381
	Group 6	£386
	Group 7	£391

Storage Cubeform

Lead Time: Standard (All products are manufactured to order and when 'Standard Lead Time' is quoted (7 – 10 days), this may vary dependant on volume ordered, factory capacity and distribution requirements at the time of ordering. For more information please contact your Dealer Business Manager or the Customer Services Team for clarification.)

Wood: Available in MFC (Ash, Autumn Cherry, Beech, Chester Oak, English Walnut, Grey, Grey Nebraska Oak, Laurentii Wenge, Natural Nebraska Oak and White)
Also available in Coloured MFC (Paraline, Petrol, Red, Sea Blue, Turquoise and Yellow)
Available in Nanotech (Black)

Metalwork: Available in Silver RAL 9006 (Standard), Black Graphite RAL 9004, White RAL 9003 and Raw finish (Add 5%)
Also available in Blue RAL 5001, Coral RAL 2001, Green RAL 6016, Light Grey RAL 7038, Teal RAL 5018 and Yellow RAL 1021 (Add 12% for all - 2 Week Lead Time)

Fabric: Group 1-7



CF/SDB

Cubeform Single Door Box

- 18mm top panel. • Can be specified on standard shelves only (not corner shelves).
- Available with Standard, Combination or Digital Keypad Lock (see below).
- Available with Standard, Whiteboard or Fabric back (see page 255).
- For coloured MFC finishes on door fronts only, see 'Coloured MFC' price and suffix .../CON (see page 255).

- Add **£0** for Standard Key Lock
- Add **£25** for Combination Lock (.../CL)
- Add **£68** for Digital Keypad Lock (.../DKL)

			MFC	Coloured MFC on Door Fronts	Black Nanotech
CF/SDB	- Standard Back	- 425w x 400d x 425h	£257	£301	£346
CF/SDB/WB	- Whiteboard Back	- 425w x 400d x 425h	£334	£378	£424
CF/SDB/FB	- Fabric Back	- 425w x 400d x 425h	—	—	—
		Group 1	£334	£378	£424
		Group 2	£340	£384	£430
		Group 3	£346	£390	£436
		Group 4	£351	£395	£441
		Group 5	£357	£401	£447
		Group 6	£362	£406	£452
		Group 7	£367	£411	£457



Standard Key Lock
Turn and open



Combination Lock
4 Digit Combination, turn and open



Digital Keypad Lock
Electronic access, turn and open



CF/DU1

Cubeform 1 Drawer Unit

- 18mm top panel. • Can be specified on standard shelves only (not corner shelves).
- Available with Standard, Whiteboard or Fabric back (see page 255).
- Lockable, includes 2x keys. • Alternative handles available (see page 234-235).
- For coloured MFC finishes on drawer fronts only, see 'Coloured MFC' price and suffix .../CON (see page 255).

			MFC	Coloured MFC on Drawer Fronts	Black Nanotech
CF/DU1	- Standard Back	- 425w x 400d x 425h	£293	£337	£382
CF/DU1/WB	- Whiteboard Back	- 425w x 400d x 425h	£370	£414	£460
CF/DU1/FB	- Fabric Back	- 425w x 400d x 425h	—	—	—
		Group 1	£370	£414	£460
		Group 2	£376	£420	£466
		Group 3	£382	£426	£472
		Group 4	£387	£431	£477
		Group 5	£393	£437	£483
		Group 6	£398	£442	£488
		Group 7	£403	£447	£493



CF/DU2

Cubeform 2 Drawer Unit

- 18mm top panel. • Can be specified on standard shelves only (not corner shelves).
- Available with Standard, Whiteboard or Fabric back (see page 255).
- Lockable, includes 2x keys. • Alternative handles available (see page 234-235).
- For coloured MFC finishes on drawer fronts only, see 'Coloured MFC' price and suffix .../CON (see page 255).

			MFC	Coloured MFC on Drawer Fronts	Black Nanotech
CF/DU2	- Standard Back	- 425w x 400d x 425h	£293	£337	£382
CF/DU2/WB	- Whiteboard Back	- 425w x 400d x 425h	£370	£414	£460
CF/DU2/FB	- Fabric Back	- 425w x 400d x 425h	—	—	—
		Group 1	£370	£414	£460
		Group 2	£376	£420	£466
		Group 3	£382	£426	£472
		Group 4	£387	£431	£477
		Group 5	£393	£437	£483
		Group 6	£398	£442	£488
		Group 7	£403	£447	£493

Storage Cubeform Home Study Station and Accessories

Lead Time: Standard (All products are manufactured to order and when 'Standard Lead Time' is quoted (7 – 10 days), this may vary dependant on volume ordered, factory capacity and distribution requirements at the time of ordering. For more information please contact your Dealer Business Manager or the Customer Services Team for clarification.)

Wood: Available in MFC (Ash, Autumn Cherry, Beech, Chester Oak, English Walnut, Grey, Grey Nebraska Oak, Laurentii Wenge, Natural Nebraska Oak and White)
Top Panel Edge Detail available on 25mm White MFC (Wenge and Black - Add £32 Retail Per Top) (Plywood - Add £42 Retail Per Top)
Specific items also available in Coloured MFC (Paraline, Petrol, Red, Sea Blue, Turquoise and Yellow)
Available in Nanotech (Black)

Metalwork: Available in Silver RAL 9006 (Standard), Black Graphite RAL 9004, White RAL 9003 and Raw finish (Add 5%)
Also available in Blue RAL 5001, Coral RAL 2001, Green RAL 6016, Light Grey RAL 7038, Teal RAL 5018 and Yellow RAL 1021 (Add 12% for all - 2 Week Lead Time)



CF/HSS15/6RH

Cubeform Home Study Station

• This item **must be securely fixed to a solid wall using the anti-tip device provided.**

• 25mm top panel. • Includes a wall fixing kit.

		MFC	Black Nanotech
CF/HSS15/6RH	- 1500w x 550d x 2065h	£1,203	£1,503
CF/HSS15/6LH	- 1500w x 550d x 2065h	£1,203	£1,503



CF/HSSDPB

Cubeform Home Study Station Double Planter Box

• 18mm top panel. • 964w x 364d x 152h internal dimensions.
• Can be specified on the Cubeform Home Study Stations overhead shelf only (not standard or corner shelves). • This unit is supplied without plants, plant tray or liner.
• The units require a waterproof membrane liner to protect against moisture and water ingress.
• For coloured MFC finishes, see 'Coloured MFC' price and suffix .../CON (see page 255).

		MFC	Coloured MFC	Black Nanotech
CF/HSSDPB	- Home Study Station Double Planter Box	£281	£351	£342
	1000w x 400d x 170h			



CF/HSSDPB/PLT1

Plants for Cubeform Home Study Double Planter Box

• Plants to be used for Cubeform Home Study Station Double Planter Boxes.

			Price
CF/HSSDPB/PLT1	- Plants for Home Study Station Double Planter Box		£952

Storage Cubeform Home Study Station Accessories

Lead Time: Standard (All products are manufactured to order and when 'Standard Lead Time' is quoted (7 – 10 days), this may vary dependant on volume ordered, factory capacity and distribution requirements at the time of ordering. For more information please contact your Dealer Business Manager or the Customer Services Team for clarification.)

Wood: Available in MFC (Ash, Autumn Cherry, Beech, Chester Oak, English Walnut, Grey, Grey Nebraska Oak, Laurentii Wenge, Natural Nebraska Oak and White)
 Top Panel Edge Detail available on 25mm White MFC (Wenge and Black - Add £32 Retail Per Top) (Plywood - Add £42 Retail Per Top)
 Specific items also available in Coloured MFC (Paraline, Petrol, Red, Sea Blue, Turquoise and Yellow)
 Available in Nanotech (Black)

Metalwork: Available in Silver RAL 9006 (Standard), Black Graphite RAL 9004, White RAL 9003 and Raw finish (Add 5%)
 Also available in Blue RAL 5001, Coral RAL 2001, Green RAL 6016, Light Grey RAL 7038, Teal RAL 5018 and Yellow RAL 1021 (Add 12% for all - 2 Week Lead Time)



CF/HSSOFB

Cubeform Home Study Station Open Fronted Box

• 25mm top panel. • Can be specified on the Cubeform Home Study Stations overhead shelf only (not standard or corner shelves).

CF/HSSOFB - Standard Back - 1000w x 400d x 425h | **MFC** £321 **Black Nanotech** £434



CF/HSSSDB

Cubeform Home Study Station Double Door Box

• 25mm top panel. • Can be specified on the Cubeform Home Study Stations overhead shelf only (not standard or corner shelves).
 • For coloured MFC finishes on door fronts only, see 'Coloured MFC' price and suffix .../CON (see below).

CF/HSSSDB - Standard Back - 1000w x 400d x 425h | **MFC** £412 **Coloured MFC on Door Fronts** £457 **Black Nanotech** £553

Cubeform Accessory Back Styles (For Open Fronted Boxes, Single Door Boxes and 2 Drawer Units Only)



Standard Back



.../WB
 Magnetic Whiteboard Back Panel



.../FB
 Fabric Back

Cubeform Coloured MFC Finishes (For Door Fronts, Drawer Fronts and Planter Boxes Only)

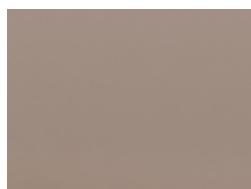

Paraline



Petrol



Red



Sea Blue



Turquoise



Yellow

Storage Cubeform Benches

Lead Time: Standard (All products are manufactured to order and when 'Standard Lead Time' is quoted (7 – 10 days), this may vary dependant on volume ordered, factory capacity and distribution requirements at the time of ordering. For more information please contact your Dealer Business Manager or the Customer Services Team for clarification.)

Wood: Available in MFC (Ash, Autumn Cherry, Beech, Chester Oak, English Walnut, Grey, Grey Nebraska Oak, Laurentii Wenge, Natural Nebraska Oak and White)
Top Panel Edge Detail available on 25mm White MFC (Wenge and Black - Add £32 Retail Per Top) (Plywood - Add £42 Retail Per Top)
Available in Nanotech (Black)

Metalwork: Available in Silver RAL 9006 (Standard), Black Graphite RAL 9004, White RAL 9003 and Raw finish (Add 5%)
Also available in Blue RAL 5001, Coral RAL 2001, Green RAL 6016, Light Grey RAL 7038, Teal RAL 5018 and Yellow RAL 1021 (Add 12% for all - 2 Week Lead Time)



CF/RB16/8

Cubeform Rectangular Bench

- 25mm top panel.
- Central support rail.

CF/RB16/8 - 1600w x 800d x 740h

CF/RB14/8 - 1400w x 800d x 740h

CF/RB12/8 - 1200w x 800d x 740h

CF/RB16/6 - 1600w x 600d x 740h

CF/RB14/6 - 1400w x 600d x 740h

CF/RB12/6 - 1200w x 600d x 740h

MFC **Black
Nanotech**

£428

£548

£406

£510

£382

£471

£406

£495

£382

£458

£357

£423



Storage Cubeform Benches

Lead Time: Standard (All products are manufactured to order and when 'Standard Lead Time' is quoted (7 – 10 days), this may vary dependant on volume ordered, factory capacity and distribution requirements at the time of ordering. For more information please contact your Dealer Business Manager or the Customer Services Team for clarification.)

Wood: Available in MFC (Ash, Autumn Cherry, Beech, Chester Oak, English Walnut, Grey, Grey Nebraska Oak, Laurentii Wenge, Natural Nebraska Oak and White)
Top Panel Edge Detail available on 25mm White MFC (Wenge and Black - Add £32 Retail Per Top) (Plywood - Add £42 Retail Per Top)
Available in Nanotech (Black)

Metalwork: Available in Silver RAL 9006 (Standard), Black Graphite RAL 9004, White RAL 9003 and Raw finish (Add 5%)
Also available in Blue RAL 5001, Coral RAL 2001, Green RAL 6016, Light Grey RAL 7038, Teal RAL 5018 and Yellow RAL 1021 (Add 12% for all - 2 Week Lead Time)

Fabric: Group 1-7



CF/RSS5

Cubeform Rectangular Single Seat with MFC Seat

• Complete with MFC seat. • 25mm top panel.

	MFC	Black Nanotech
CF/RSS8 - 800w x 350d x 465h	£393	£420
CF/RSS5 - 475w x 350d x 465h	£363	£379



CF/RSS5/F

Cubeform Rectangular Single Seat with Fully Upholstered Seat

• Complete with upholstered seat.

		Fabric
CF/RSS8/F - 800w x 350d x 530h	Group 1	£545
	Group 2	£562
	Group 3	£579
	Group 4	£598
	Group 5	£618
	Group 6	£638
	Group 7	£688
CF/RSS5/F - 475w x 350d x 530h	Group 1	£474
	Group 2	£489
	Group 3	£504
	Group 4	£517
	Group 5	£532
	Group 6	£550
	Group 7	£595



CF/RDS14

Cubeform Rectangular Bench Seat with MFC Seat

• Complete with MFC seat. • 25mm top panel.

	MFC	Black Nanotech
CF/RDS14 - 1400w x 350d x 465h	£442	£485
CF/RDS12 - 1200w x 350d x 465h	£411	£451
CF/RDS10 - 1000w x 350d x 465h	£382	£414



CF/RDS14/F

Cubeform Rectangular Bench Seat with Fully Upholstered Seat

• Complete with upholstered seat.

		Fabric
CF/RDS14/F - 1400w x 350d x 530h	Group 1	£664
	Group 2	£691
	Group 3	£720
	Group 4	£749
	Group 5	£780
	Group 6	£810
	Group 7	£882
CF/RDS12/F - 1200w x 350d x 530h	Group 1	£611
	Group 2	£635
	Group 3	£661
	Group 4	£688
	Group 5	£713
	Group 6	£742
	Group 7	£812
CF/RDS10/F - 1000w x 350d x 530h	Group 1	£558
	Group 2	£579
	Group 3	£603
	Group 4	£626
	Group 5	£651
	Group 6	£676
	Group 7	£742

Storage Cubeform Coffee Tables

Lead Time: Standard (All products are manufactured to order and when 'Standard Lead Time' is quoted (7 – 10 days), this may vary dependant on volume ordered, factory capacity and distribution requirements at the time of ordering. For more information please contact your Dealer Business Manager or the Customer Services Team for clarification.)

Wood: Available in MFC (Ash, Autumn Cherry, Beech, Chester Oak, English Walnut, Grey, Grey Nebraska Oak, Laurentii Wenge, Natural Nebraska Oak and White)
Top Panel Edge Detail available on 25mm White MFC (Wenge and Black - Add £32 Retail Per Top) (Plywood - Add £42 Retail Per Top)
Available in Nanotech (Black)

Metalwork: Available in Silver RAL 9006 (Standard), Black Graphite RAL 9004, White RAL 9003 and Raw finish (Add 5%)
Also available in Blue RAL 5001, Coral RAL 2001, Green RAL 6016, Light Grey RAL 7038, Teal RAL 5018 and Yellow RAL 1021 (Add 12% for all - 2 Week Lead Time)

Cubeform Rectangular / Square Coffee Table

• 25mm top panel.



CF/SCT1

CF/SCT1 - 475w x 475d x 400h

MFC

Black Nanotech

£393

£414



CF/SCT2

CF/SCT2 - 900w x 900d x 400h

£489

£564



CF/RCT1

CF/RCT1 - 900w x 475d x 400h

£442

£480

Cubeform Rectangular / Square Coffee Table with Base Panel

• 25mm top panel and 18mm base panel.



CF/SCT1/BP

CF/SCT1/BP - 475w x 475d x 400h

MFC

Black Nanotech

£453

£497



CF/SCT2/BP

CF/SCT2/BP - 900w x 900d x 400h

£548

£697



CF/RCT1/BP

CF/RCT1/BP - 900w x 475d x 400h

£501

£579



Storage Modular Lockers



Storage Modular Lockers

How to Specify Modular Lockers

Choose any amount of modular lockers required for the given job using the code combinations below.

A - 1x 1050h Door

1x 1050h door with individual compartment and coat rail

B - 3x 350h Doors

3x 350h doors with individual compartments

C - 1x 350h Door and 1x 700h Door

1x 350h door with an individual compartment
1x 700h door with 2x compartments

D - 1x 350h Door and 1x 700h Door

1x 700h door with 2x compartments
1x 350h door with an individual compartment

E - 1x 1400h Door

1x 1400h door with 2x compartments and coat rail

F - 4x 350h Doors

4x 350h doors with individual compartments

G - 2x 700h Door

2x 700h doors with 2x compartments each

H - 2x 350h Doors and 1x 700h Door

2x 350h doors with individual compartments
1x 700h door with 2x compartments

J - 2x 350h Doors and 1x 700h Door

1x 350h door with an individual compartment
1x 700h door with 2x compartments
1x 350h door with an individual compartment

K - 2x 350h Doors and 1x 700h Door

1x 700h door with 2x compartments
2x 350h doors with individual compartments

L - 1x 350h Door and 1x 1050h Door

1x 350h door with an individual compartment
1x 1050h door with coat rail

M - 1x 1050h Door and 1x 350h Door

1x 1050h door with coat rail
1x 350h door with an individual compartment

There are 3 locking styles to choose from, these are Standard Lock, Combination Lock and Digital Keypad Lock. Suffix the relevant code onto the end of the unit code (e.g. for use of the Digital Keypad Lock on the NML/3B, use code NML/3B/DKL). An additional cost per unit will need to be added to the order. See individual pages for details.

Additionally, an Integrated Postal Slot can be specified using suffix .../PST. A Modular Locker Specification Form will need to be supplied with your order which will detail which doors require a postal slot. An additional cost per door will need to be added to the order. See page 263 for details.

For contrasting finishes on any or all the doors so it is different to the carcass, suffix .../CON. A Modular Locker Specification Form will need to be supplied with your order which will detail what finishes you require and where. If you decide to use one of the coloured MFC finishes, only available on door fronts, this can also be detailed on the Modular Locker Specification Form. An additional cost per door will need to be added to the order. See page 263 for details.

Once chosen, specify the length of the modular lockers top / bottom by suffixing the amount of modular lockers used onto the end of its code (e.g. when 3x modular lockers are specified, use code NML/TB3). See page 263 for details.

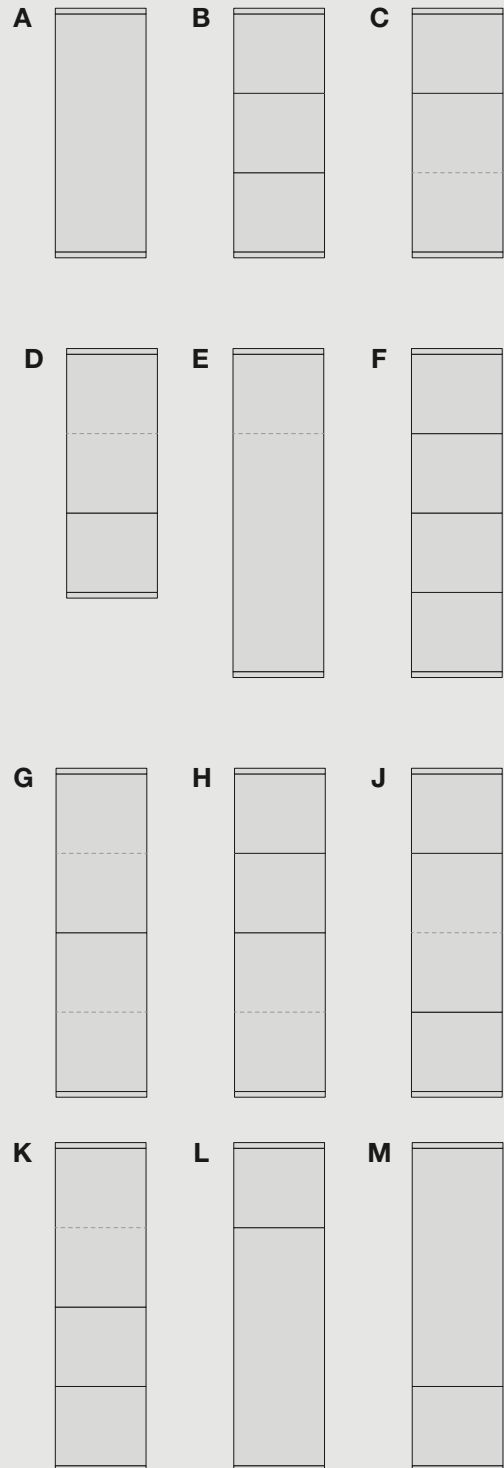

Storage Modular Lockers

Lead Time: Standard (All products are manufactured to order and when 'Standard Lead Time' is quoted (7 – 10 days), this may vary dependant on volume ordered, factory capacity and distribution requirements at the time of ordering. For more information please contact your Dealer Business Manager or the Customer Services Team for clarification.)

Wood: Available in MFC (Ash, Autumn Cherry, Beech, Chester Oak, English Walnut, Grey, Grey Nebraska Oak, Laurentii Wenge, Natural Nebraska Oak and White)
Top Panel Edge Detail available on 25mm White MFC (Wenge and Black - Add £32 Retail Per Top) (Plywood - Add £42 Retail Per Top)
Specific items also available in Coloured MFC (Paraline, Petrol, Red, Sea Blue, Turquoise and Yellow)



NML/3A

Modular Locker Unit with Single Door

- **Modular locker top / bottom required with this product (see page 263).**
- 18mm top panel. • 1115h is including Modular Locker Top and Bottom.
- 1x lockable door with a clothing compartment and coat rail.
- Clothing internal compartment size is 360w x 462d x 1025h.

MFC

NML/3A - 1x 1050h Door - 400w x 500d x 1115h | £295

- Add £0 for Standard Key Lock
 - Add £25 for Combination Lock (.../CL)
 - Add £68 for Digital Keypad Lock (.../DKL)
 - Add £0 per door for Standard MFC Contrasting Door Finish (.../CON)
 - Add £25 per door for Coloured MFC Contrasting Door Finish (.../CON)
- Further information required, contact Customer Services for specification form (see page 263).



NML/3B

Modular Locker Unit with 3x Individual Doors

- **Modular locker top / bottom required with this product (see page 263).**
- 18mm top panel. • 1115h is including Modular Locker Top and Bottom.
- 3x lockable doors with individual compartments.
- Individual internal compartment sizes are 360w x 462d x 325h (min).

MFC

NML/3B - 3x 350h Doors - 400w x 500d x 1115h | £423

- Add £0 for Standard Key Locks
 - Add £75 for Combination Locks (.../CL)
 - Add £204 for Digital Keypad Locks (.../DKL)
 - Add £23 per door for Postal Slots (.../PST)
 - Add £0 per door for Standard MFC Contrasting Door Finishes (.../CON)
 - Add £25 per door for Coloured MFC Contrasting Door Finishes (.../CON)
- Further information required, contact Customer Services for specification form (see page 263).



NML/3C

Modular Locker Unit with 2x Individual Doors

- **Modular locker top / bottom required with this product (see page 263).**
- 18mm top panel. • 1115h is including Modular Locker Top and Bottom.
- 1x lockable door with an individual compartment. • 1x lockable door with 2x compartments.
- Individual internal compartment sizes are 360w x 462d x 325h (min).

MFC

NML/3C - 1x 350h Door (Top) and 1x 700h Door (Bottom) - 400w x 500d x 1115h | £381
NML/3D - 1x 700h Door (Top) and 1x 350h Door (Bottom) - 400w x 500d x 1115h | £381

- Add £0 for Standard Key Locks
 - Add £50 for Combination Locks (.../CL)
 - Add £136 for Digital Keypad Locks (.../DKL)
 - Add £23 per door for Postal Slots (.../PST)
 - Add £0 per door for Standard MFC Contrasting Door Finishes (.../CON)
 - Add £25 per door for Coloured MFC Contrasting Door Finishes (.../CON)
- Further information required, contact Customer Services for specification form (see page 263).



NML/4E

Modular Locker Unit with Single Door

- **Modular locker top / bottom required with this product (see page 263).**
- 18mm top panel. • 1465h is including Modular Locker Top and Bottom.
- 1x lockable door with an individual compartment and 1x clothing compartment and coat rail.
- Individual internal compartment size is 360w x 462d x 325h.
- Clothing internal compartment size is 360w x 462d x 1017h.

MFC

NML/4E - 1x 1400h Door - 400w x 500d x 1465h | £368

- Add £0 for Standard Key Lock
 - Add £25 for Combination Lock (.../CL)
 - Add £68 for Digital Keypad Lock (.../DKL)
 - Add £23 per door for a Postal Slot (.../PST)
 - Add £0 per door for Standard MFC Contrasting Door Finish (.../CON)
 - Add £25 per door for Coloured MFC Contrasting Door Finish (.../CON)
- Further information required, contact Customer Services for specification form (see page 263).

Storage Modular Lockers

Lead Time: Standard (All products are manufactured to order and when 'Standard Lead Time' is quoted (7 – 10 days), this may vary dependant on volume ordered, factory capacity and distribution requirements at the time of ordering. For more information please contact your Dealer Business Manager or the Customer Services Team for clarification.)

Wood: Available in MFC (Ash, Autumn Cherry, Beech, Chester Oak, English Walnut, Grey, Grey Nebraska Oak, Laurentii Wenge, Natural Nebraska Oak and White)
Top Panel Edge Detail available on 25mm White MFC (Wenge and Black - Add **£32** Retail Per Top) (Plywood - Add **£42** Retail Per Top)
Specific items also available in Coloured MFC (Paraline, Petrol, Red, Sea Blue, Turquoise and Yellow)



NML/4F

Modular Locker Unit with 4x Individual Doors

- **Modular locker top / bottom required with this product (see page 263).**
- 18mm top panel. • 1465h is including Modular Locker Top and Bottom.
- 4x lockable doors with individual compartments.
- Individual internal compartment sizes are 360w x 462d x 325h (min).

MFC

NML/4F - 4x 350h Doors - 400w x 500d x 1465h ————— | **£528**

- Add **£0** for Standard Key Locks
 - Add **£100** for Combination Locks (.../CL)
 - Add **£272** for Digital Keypad Locks (.../DKL)
 - Add **£23** per door for Postal Slots (.../PST)
 - Add **£0** per door for Standard MFC Contrasting Door Finishes (.../CON)
 - Add **£25** per door for Coloured MFC Contrasting Door Finishes (.../CON)
- Further information required, contact Customer Services for specification form (see page 263).



NML/4G

Modular Locker Unit with 2x Individual Doors

- **Modular locker top / bottom required with this product (see page 263).**
- 18mm top panel. • 1465h is including Modular Locker Top and Bottom.
- 2x lockable doors with 2x compartments each.
- Individual internal compartment sizes are 360w x 462d x 325h (min).

MFC

NML/4G - 2x 700h Doors - 400w x 500d x 1465h ————— | **£443**

- Add **£0** for Standard Key Locks
 - Add **£50** for Combination Locks (.../CL)
 - Add **£136** for Digital Keypad Locks (.../DKL)
 - Add **£23** per door for Postal Slots (.../PST)
 - Add **£0** per door for Standard MFC Contrasting Door Finishes (.../CON)
 - Add **£25** per door for Coloured MFC Contrasting Door Finishes (.../CON)
- Further information required, contact Customer Services for specification form (see page 263).



NML/4H

Modular Locker Unit with 3x Individual Doors

- **Modular locker top / bottom required with this product (see page 263).**
- 18mm top panel. • 1465h is including Modular Locker Top and Bottom.
- 2x lockable doors with individual compartments. • 1x lockable door with 2x compartments.
- Individual internal compartment sizes are 360w x 462d x 325h (min).

MFC

NML/4H - 2x 350h Doors (Top) and 1x 700h Door (Bottom) - 400w x 500d x 1465h — | **£479**
NML/4J - 2x 350h Doors (Top and Bottom) and 1x 700h Door (Middle) - 400w x 500d x 1465h — | **£479**
NML/4K - 1x 700h Door (Top) and 2x 350h Doors (Bottom) - 400w x 500d x 1465h — | **£479**

- Add **£0** for Standard Key Locks
 - Add **£75** for Combination Locks (.../CL)
 - Add **£204** for Digital Keypad Locks (.../DKL)
 - Add **£23** per door for Postal Slots (.../PST)
 - Add **£0** per door for Standard MFC Contrasting Door Finishes (.../CON)
 - Add **£25** per door for Coloured MFC Contrasting Door Finishes (.../CON)
- Further information required, contact Customer Services for specification form (see page 263).



NML/4L

Modular Locker Unit with 2x Individual Doors

- **Modular locker top / bottom required with this product (see page 263).**
- 18mm top panel. • 1465h is including Modular Locker Top and Bottom.
- 1x lockable door with an individual compartment. • 1x lockable door with a clothing compartment and coat rail.
- Individual internal compartment sizes are 360w x 462d x 325h (min).
- Clothing internal compartment size is 360w x 462d x 1025h.

MFC

NML/4L - 1x 350h Door (Top) and 1x 1050h Door (Bottom) - 400w x 500d x 1465h ————— | **£454**
NML/4M - 1x 1050h Door (Top) and 1x 350h Door (Bottom) - 400w x 500d x 1465h ————— | **£454**

- Add **£0** for Standard Key Locks
 - Add **£50** for Combination Locks (.../CL)
 - Add **£136** for Digital Keypad Locks (.../DKL)
 - Add **£23** per door for Postal Slots (.../PST)
 - Add **£0** per door for Standard MFC Contrasting Door Finishes (.../CON)
 - Add **£25** per door for Coloured MFC Contrasting Door Finishes (.../CON)
- Further information required, contact Customer Services for specification form (see page 263).

Storage Modular Lockers

Lead Time: Standard (All products are manufactured to order and when 'Standard Lead Time' is quoted (7 – 10 days), this may vary dependant on volume ordered, factory capacity and distribution requirements at the time of ordering. For more information please contact your Dealer Business Manager or the Customer Services Team for clarification.)

Wood: Available in MFC (Ash, Autumn Cherry, Beech, Chester Oak, English Walnut, Grey, Grey Nebraska Oak, Laurentii Wenge, Natural Nebraska Oak and White)
 Top Panel Edge Detail available on 25mm White MFC (Wenge and Black - Add £32 Retail Per Top) (Plywood - Add £42 Retail Per Top)
 Specific items also available in Coloured MFC (Paraline, Petrol, Red, Sea Blue, Turquoise and Yellow)



NML_4F_CON

Contrasting Door Finish

• 18mm top panel. • To apply a contrasting door to the carcass, suffix **.../CON** to your chosen unit and submit a Modular Locker Specification Form.

	Price
.../CON - Standard MFCs - Contrasting Door to the Carcase - Price per Door _____	
.../CON - Coloured MFCs - Contrasting Door to the Carcase - Price per Door _____	£25



NML_4F_PST

Modular Locker Postal Slot

• To apply a postal slot to any door, suffix **.../PST** to your chosen unit and submit a Modular Locker Specification Form. • Postal Slots are 25h.

	Price
.../PST - Postal Slot in a Door - Price per Door _____	£23



NML/TB4
 Illustrated in red

Modular Locker Top and Bottom

• 25mm top panel. • Specify the modular locker top and bottom dependent of how many modular lockers you are using in a singular run.
 • Both top and bottom single piece panels supplied.

	MFC
NML/TB1 - For 1x Modular Locker - 400w x 500d _____	£148
NML/TB2 - For 2x Modular Lockers - 800w x 500d _____	£172
NML/TB3 - For 3x Modular Lockers - 1200w x 500d _____	£197
NML/TB4 - For 4x Modular Lockers - 1600w x 500d _____	£220
NML/TB5 - For 5x Modular Lockers - 2000w x 500d _____	£245
NML/TB6 - For 6x Modular Lockers - 2400w x 500d _____	£270



Storage Modular Lockers



Modular Locker Locking Styles



Standard Key Lock
Turn and open



Combination Lock
4 Digit Combination, turn and open



Digital Keypad Lock
Electronic access, turn and open

Modular Locker Premium MFC Finishes (For Door Fronts Only)

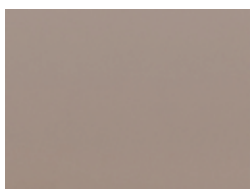

Paraline



Petrol



Red



Sea Blue



Turquoise



Yellow

Storage Hotbox

Lead Time: Standard (All products are manufactured to order and when 'Standard Lead Time' is quoted (7 – 10 days), this may vary dependant on volume ordered, factory capacity and distribution requirements at the time of ordering. For more information please contact your Dealer Business Manager or the Customer Services Team for clarification.)



H3RGAL

HotBox 3 Unit

- £63 surcharge on orders below 10 units.
- Hotbox 3 satchel in Camira Rivet with shoulder strap, side pull handle and card holder.
- Fabric pen holder and accessories not included.

					Price
H3RGAL	- Camira Rivet: Galvanise	- 420w x 150d x 320h	_____		£197
H3RQUE	- Camira Rivet: Quench	- 420w x 150d x 320h	_____		£197
H3RFOR	- Camira Rivet: Forge	- 420w x 150d x 320h	_____		£197
H3RCHA	- Camira Rivet: Charcoal	- 420w x 150d x 320h	_____		£197



Galvanise



Quench



Forge



Charcoal



Hotbox 2 Unit

- Main body in white with 2x utility pots.
- Includes tablet strap.
- Fabric bib, fabric pen holder and accessories not included.

				Price
EHB2RN	- 426w x 125d x 311h	_____		£95



EHB2RN

Hotbox 2 Fabric Bib

- £63 surcharge on orders below 10 units.
- Individual fabric bibs to fix onto EHB2RN.

				Price
EHB2B1	- Camira Blazer: Winchester	_____		£78
EHB2B2	- Camira Blazer: Newport	_____		£78
EHB2B3	- Camira Blazer: Manchester	_____		£78
EHB2B4	- Camira Blazer: Goldsmith	_____		£78
EHB2B5	- Camira Blazer: Surrey	_____		£78
EHB2B6	- Camira Nexus: Kiwi	_____		£67
EHB2B7	- Camira Nexus: Sky	_____		£67
EHB2B8	- Camira Nexus: Petrol	_____		£67
EHB2B9	- Camira Nexus: Pewter	_____		£67
EHB2B10	- Camira Nexus: Russian	_____		£67



EHB2B5

Storage Hotbox

Lead Time: Standard (All products are manufactured to order and when 'Standard Lead Time' is quoted (7 – 10 days), this may vary dependant on volume ordered, factory capacity and distribution requirements at the time of ordering. For more information please contact your Dealer Business Manager or the Customer Services Team for clarification.)



EHB2R/B2

HotBox 2 Unit with Fabric Bib

- £63 surcharge on orders below 10 units.
- Main body in white with 2x utility pots and fabric bib.
- Fabric pen holder and accessories not included.

	Price
EHB2R/B1 - Camira Blazer: Winchester	£172
EHB2R/B2 - Camira Blazer: Newport	£172
EHB2R/B3 - Camira Blazer: Manchester	£172
EHB2R/B4 - Camira Blazer: Goldsmith	£172
EHB2R/B5 - Camira Blazer: Surrey	£172
EHB2R/B6 - Camira Nexus: Kiwi	£160
EHB2R/B7 - Camira Nexus: Sky	£160
EHB2R/B8 - Camira Nexus: Petrol	£160
EHB2R/B9 - Camira Nexus: Pewter	£160
EHB2R/B10 - Camira Nexus: Russian	£160



Winchester



Newport



Manchester



Goldsmith



Surrey



Kiwi



Sky



Petrol



Pewter



Russian



EHB2ST/G

Hotbox 2 Shoulder Strap

- Fixes onto the Hotbox 2 Unit and allows the unit to be carried with ease.

	Price
EHB2ST/G - Grey	£37
EHB2ST/B - Black	£37



Storage Recycling Units



Storage Recycling Units

Lead Time: Standard (All products are manufactured to order and when 'Standard Lead Time' is quoted (7 – 10 days), this may vary dependant on volume ordered, factory capacity and distribution requirements at the time of ordering. For more information please contact your Dealer Business Manager or the Customer Services Team for clarification.)

Wood: Available in MFC (Ash, Autumn Cherry, Beech, Chester Oak, English Walnut, Grey, Grey Nebraska Oak, Laurentii Wenge, Natural Nebraska Oak and White)
Top Panel Edge Detail available on 25mm White MFC (Wenge and Black - Add £32 Retail Per Top) (Plywood - Add £42 Retail Per Top)



RU8/5/10

Recycling Unit with 2 Sections

- 25mm top panel. • 2x hinged doors.
- Complete with 2x cardboard recycling boxes and 6x adhesive recycling stickers.
- Lockable, includes 2x keys. • Alternative handles available (see page 234-235).

MFC

RU8/5/10	- 1x Adjustable Shelf	- 800w x 500d x 1000h	_____	£664
RU8/4/10	- 1x Adjustable Shelf	- 800w x 400d x 1000h	_____	£598
RU8/5/7	- 800w x 500d x 740h	_____	_____	£598
RU8/4/7	- 800w x 400d x 740h	_____	_____	£537



RU10/5/10

Recycling Unit with 3 Sections

- 25mm top panel. • 2x hinged doors.
- Complete with 3x cardboard recycling boxes and 6 adhesive recycling stickers.
- Lockable, includes 2x keys. • Alternative handles available (see page 234-235).

MFC

RU10/5/10	- 1x Adjustable Shelf	- 990w x 500d x 1000h	_____	£797
RU10/4/10	- 1x Adjustable Shelf	- 990w x 400d x 1000h	_____	£718
RU10/5/7	- 990w x 500d x 740h	_____	_____	£718
RU10/4/7	- 990w x 400d x 740h	_____	_____	£649



RU13/5/10

Recycling Unit with 4 Sections

- 25mm top panel. • 2x hinged doors.
- Complete with 4x cardboard recycling boxes and 6x adhesive recycling stickers.
- Lockable, includes 2x keys. • Alternative handles available (see page 234-235).

MFC

RU13/5/10	- 1x Adjustable Shelf	- 1300w x 500d x 1000h	_____	£930
RU13/4/10	- 1x Adjustable Shelf	- 1300w x 400d x 1000h	_____	£836
RU13/5/7	- 1300w x 500d x 740h	_____	_____	£836
RU13/4/7	- 1300w x 400d x 740h	_____	_____	£759



6x Adhesive Stickers

Adhesive Stickers

- 6x adhesive stickers available with recycling units (see above).



RUB

Replacement Recycling Boxes

- Cardboard recycling boxes compatible with recycling units (see above).

Price

RUB	- 300w x 300d x 600h	_____	_____	£13
------------	----------------------	-------	-------	-----

Lead Time: 4 Weeks

Metalwork: Available in Silver RAL 9006 (Standard), Black AV1 and White BC3



SYC10/0/2

Elite 2 Drawer Steel Systemfile Side Filer

- 4 week lead time.
- 2x pull out drawers.
- Fitted with counterbalance.
- Locking drawers.
- Additional MFC top available (see page 270).
- 10 year guarantee.

Metalwork

SYC10/0/2 - 1000w x 470d x 693h _____

£1,107

SYC08/0/2 - 800w x 470d x 693h _____

£1,026

- 2x Filing Drawers



SYC10/0/3

Elite 3 Drawer Steel Systemfile Side Filer

- 4 week lead time.
- 3x pull out drawers.
- Fitted with counterbalance.
- Locking drawers.
- Additional MFC top available (see page 270).
- 10 year guarantee.

Metalwork

SYC10/0/3 - 1000w x 470d x 997h _____

£1,379

SYC08/0/3 - 800w x 470d x 997h _____

£1,324

- 3x Filing Drawers



SYC10/0/4

Elite 4 Drawer Steel Systemfile Side Filer

- 4 week lead time.
- 4x pull out drawers.
- Fitted with counterbalance.
- Locking drawers.
- Additional MFC top available (see page 270).
- 10 year guarantee.

Metalwork

SYC10/0/4 - 1000w x 470d x 1301h _____

£1,649

SYC08/0/4 - 800w x 470d x 1301h _____

£1,609

- 4x Filing Drawers



Lead Time: 4 Weeks

Wood: Available in MFC (Ash, Autumn Cherry, Beech, Chester Oak, English Walnut, Grey, Grey Nebraska Oak, Laurentii Wenge, Natural Nebraska Oak and White)
Top Panel Edge Detail available on 25mm White MFC (Wenge and Black - Add £32 Retail Per Top) (Plywood - Add £42 Retail Per Top)
Available in Veneer (Oak and Walnut) on a 3 Week Lead Time

Metalwork: Available in Silver RAL 9006 (Standard), Black AV1 and White BC3



SYD10/6

Elite Steel Systemfile Storage Unit

- 4 week lead time.
- 2x door storage unit.
- Locking doors.
- Additional MFC top available (see below).
- 10 year guarantee.

Metalwork

SYD10/6	- 1000w x 470d x 1947h	£1,243
SYD10/54	- 1000w x 470d x 1795h	£1,143
SYD10/50	- 1000w x 470d x 1643h	£1,131
SYD10/34	- 1000w x 470d x 1149h	£933
SYD10/3	- 1000w x 470d x 997h	£864
SYD10/2	- 1000w x 470d x 693h	£755
SYD08/6	- 800w x 470d x 1947h	£1,062
SYD08/54	- 800w x 470d x 1795h	£1,008
SYD08/50	- 800w x 470d x 1643h	£999
SYD08/34	- 800w x 470d x 1149h	£828
SYD08/3	- 800w x 470d x 997h	£755
SYD08/2	- 800w x 470d x 693h	£657



SYT10/6

Elite Steel Systemfile Tambour Storage Unit

- 4 week lead time.
- 800w unit supplied with 1x door and 1000w unit supplied with 2x doors.
- Locking doors.
- Additional MFC top available (see below).
- 10 year guarantee.

Metalwork

SYT10/6	- 1000w x 470d x 1947h	£1,277
SYT10/54	- 1000w x 470d x 1795h	£1,143
SYT10/50	- 1000w x 470d x 1643h	£1,165
SYT10/34	- 1000w x 470d x 1149h	£968
SYT10/3	- 1000w x 470d x 997h	£899
SYT10/2	- 1000w x 470d x 693h	£799
• 2x Tambour Doors		
SYT08/34	- 800w x 470d x 1149h	£871
SYT08/3	- 800w x 470d x 997h	£799
SYT08/2	- 800w x 470d x 693h	£693
• 1x Tambour Door		



EBTW3BRLS/RH

Elite Tower

- 4 week lead time.
- Pull out drawer with 2x levels of A4 filing.
- 18mm top panel.
- Locking unit.
- Adjustable shelves.
- Including tool ladder / management rail.

Metalwork

EBTW3BRLS/LH	- 450w x 800d x 1118h	£2,009
EBTW3BRLS/RH	- 450w x 800d x 1118h	£2,009



ESSMFCT10

Elite Systemfile MFC Top

- 25mm top panel.
- MFC top for all Elite systemfile items.
- Supplied loose with adhesive pads.
- Increases storage height by 25mm.

MFC Veneer (3 Week Lead Time)

ESSMFCT10	- 1000w x 470d x 25h	£110	£173
ESSMFCT8	- 800w x 470d x 25h	£94	£158

Storage Steel Storage Accessories

Lead Time: Standard (All products are manufactured to order and when 'Standard Lead Time' is quoted (7 – 10 days), this may vary dependant on volume ordered, factory capacity and distribution requirements at the time of ordering. For more information please contact your Dealer Business Manager or the Customer Services Team for clarification.)



BIC10BSPS

Standard Shelf

- Single shelf.

	Price
BIC10BSPS - For Elite Systemfile Steel Cupboards	£36
BIC08BSPS - For Elite Systemfile Steel Cupboards	£36
BIT10BSPS - For Elite Systemfile Steel Tambour Cupboards	£36
BIT08BSPS - For Elite Systemfile Steel Tambour Cupboards	£36



BIT10RSPS

Pull Out Reference Shelf

- Single shelf.

	Price
BIC10RSPS - For Elite Systemfile Steel Cupboards	£119
BIC08RSPS - For Elite Systemfile Steel Cupboards	£119
BIT10RSPS - For Elite Systemfile Steel Tambour Cupboards	£119
BIT08RSPS - For Elite Systemfile Steel Tambour Cupboards	£119



BIT10SSPDPS - SHDV65P5PS

Slotted Filing Shelf with Dividers

- Single shelf. • 5x dividers.

	Price
BIC10SSPDPS - For Elite Systemfile Steel Cupboards - Slotted Filing Shelf Only	£56
BIC08SSPDPS - For Elite Systemfile Steel Cupboards - Slotted Filing Shelf Only	£56
BIT10SSPDPS - For Elite Systemfile Steel Tambour Cupboards - Slotted Filing Shelf Only	£56
BIT08SSPDPS - For Elite Systemfile Steel Tambour Cupboards - Slotted Filing Shelf Only	£56
SHDV65P5PS - 5 Dividers Only	£56



BIT10LRPS

Lateral Filing Cradle

- Adjustable lateral filing cradle, between 190mm and 330mm centres.

	Price
BIC10LRPS - For Elite Systemfile Steel Cupboards	£56
BIC08LRPS - For Elite Systemfile Steel Cupboards	£56
BIT10LRPS - For Elite Systemfile Steel Tambour Cupboards	£56
BIT08LRPS - For Elite Systemfile Steel Tambour Cupboards	£56



BIT10RFAPS

Pull Out Vertical Filing Cradle

- Complete with 2x cross bars to accept foolscap filing side on.
- Standard foolscap and A4 filing front to back.

	Price
BIC10RFAPS - For Elite Systemfile Steel Cupboards	£138
BIC08RFAPS - For Elite Systemfile Steel Cupboards	£138
BIT10RFAPS - For Elite Systemfile Steel Tambour Cupboards	£138
BIT08RFAPS - For Elite Systemfile Steel Tambour Cupboards	£138



BIT10RDAPS

Pull Out Vertical Drawer

- Drawer is 100mm deep.

	Price
BIC10RDAPS - For Elite Systemfile Steel Cupboards	£179
BIC08RDAPS - For Elite Systemfile Steel Cupboards	£179
BIT10RDAPS - For Elite Systemfile Steel Tambour Cupboards	£179
BIT08RDAPS - For Elite Systemfile Steel Tambour Cupboards	£179

Desk Mounted Screens

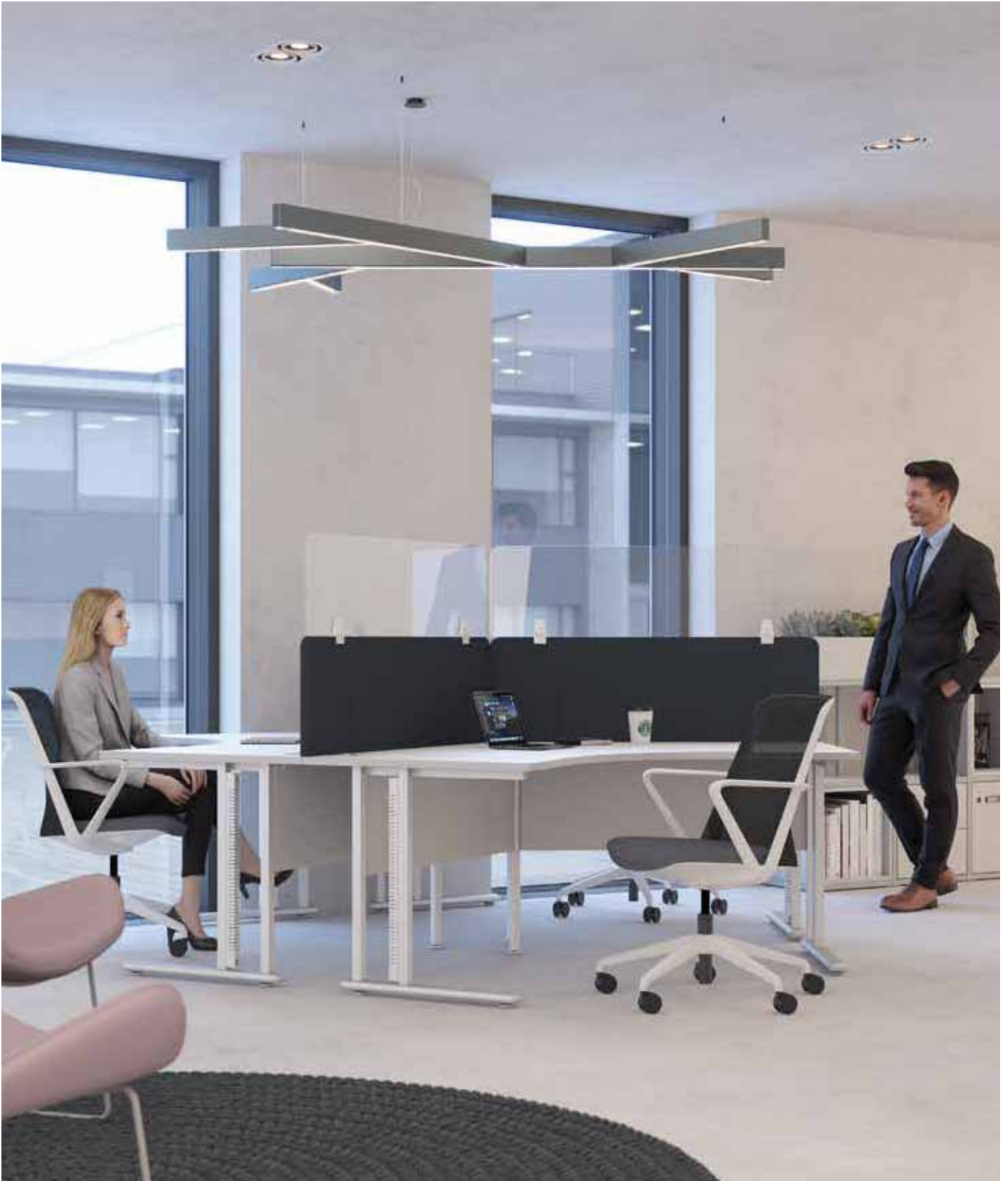

Desk mounted screens act as a division between multiple users, adding a degree of privacy if required. The portfolio provides compatible desk mounted screens in several styles, for all desking ranges manufactured by Elite Office Furniture. The options include frameless and aluminium trim panels, manufactured from acrylic, MFC, or with an upholstered finish. A range of acoustic screens certified to Class B International Standards, ISO 354:2003, ISO11654:1997, ISO9613 & ISO9613-1:1993, are available for over desk applications.

Screens Desk Mounted Screens for Specific Ranges

Progress Plus Desk Mounted Screens

- System Screen with Optional Management Rail.
- Acoustic Screen.
- Blade Screen Panel.
- See page 26-30.



PPSS16F



AESS16F



EBS16F/F3

Progress Desk Mounted Screens

- System Screen with Optional Management Rail.
- Acoustic Screen.
- See page 37-41.



PSS16/F



AESS16F



EBS16F/F3

Progress Lite Desk Mounted Screens

- System Screen with Optional Management Rail.
- Acoustic Screen.
- See page 44-45.



PLSS16F



APLSS16F

Linnea Elevate Desk Mounted Screens

- System Screen with Optional Management Rail.
- Acoustic Screen.
- See page 50-53.



LESS16F



AESS16F/E

Lux Desk Mounted Screens

- Acoustic Screen.
- See page 63-64.



AELUXSS10F

Linnea Desk Mounted Screens

- System Screen with Optional Management Rail.
- Acoustic Screen.
- Flexible Return Contract Screen.
- Flexible Return Glazed Screen.
- See page 80-90.



ELSS16F



ECSFR8



AESS16F

Matrix Desk Mounted Screens

- Height Settable System Screen with Optional Management Rail.
- System Screen with Optional Management Rail.
- Acoustic Screen.
- Flexible Return Contract Screen.
- Contract Screen
- See page 100-109.



ASS16F



ELSS16F



ECS16F/X

Screens System Screens for Single Desks

Lead Time: Standard (All products are manufactured to order and when 'Standard Lead Time' is quoted (7 – 10 days), this may vary dependant on volume ordered, factory capacity and distribution requirements at the time of ordering. For more information please contact your Dealer Business Manager or the Customer Services Team for clarification.)

Compatible: Reflex, Kassini, Optima Plus, Callisto, Windsor and Flexi

Metalwork: Available in Anodised Silver (Standard), Black Graphite RAL 9004 and White RAL 9003

Fabric: Fully upholstered with pinnable surface available in Groups 1-7

Acrylic: Available in Blue, Green, Orange, Red, Frosted and Clear

MFC: Available in Ash, Autumn Cherry, Beech, Chester Oak, English Walnut, Grey, Grey Nebraska Oak, Laurentii Wenge, Natural Nebraska Oak and White

Elite Desk Mounted System Screen for Single Desks

- Straight dividing screens with aluminium trim and optional management rail.
- Screen is bracketed to the outer edge of the desk top.
- Optional 4 way link post available (**ELP375**).
- Available as Hygiene Protection Screens and add-ons (see page 282-284).

- For Fabric, suffix ...F
- For Acrylic, suffix ...A
- For MFC without Management Rail, suffix ...MFC
- For MFC with Management Rail, suffix .../MFC



Straight System Screen

	Group 1	Group 2	Group 3	Group 4	Group 5	Group 6	Group 7	Acrylic	MFC
ESS20... - 1973w x 27d x 375h	£444	£456	£468	£480	£492	£504	£516	£444	£401
ESS18... - 1773w x 27d x 375h	£419	£431	£443	£455	£467	£479	£491	£419	£382
ESS16... - 1573w x 27d x 375h	£385	£397	£409	£421	£433	£445	£457	£385	£351
ESS14... - 1373w x 27d x 375h	£357	£369	£381	£393	£405	£417	£429	£357	£324
ESS12... - 1173w x 27d x 375h	£325	£337	£349	£361	£373	£385	£397	£325	£295
ESS10... - 973w x 27d x 375h	£307	£319	£331	£343	£355	£367	£379	£307	£280
ESS8... - 773w x 27d x 375h	£295	£307	£319	£331	£343	£355	£367	£295	£263

Straight System Screen with Management Rail

ESS20M... - 1973w x 27d x 375h	£597	£609	£621	£633	£645	£657	£669	£597	£538
ESS18M... - 1773w x 27d x 375h	£559	£571	£583	£595	£607	£619	£631	£559	£507
ESS16M... - 1573w x 27d x 375h	£516	£528	£540	£552	£564	£576	£588	£516	£469
ESS14M... - 1373w x 27d x 375h	£454	£466	£478	£490	£502	£514	£526	£454	£431
ESS12M... - 1173w x 27d x 375h	£422	£434	£446	£458	£470	£482	£494	£422	£382
ESS10M... - 973w x 27d x 375h	£385	£397	£409	£421	£433	£445	£457	£385	£348
ESS8M... - 773w x 27d x 375h	£357	£369	£381	£393	£405	£417	£429	£357	£331

Link Post

ELP375 - 4 Way | £72 |

Elite Desk Mounted System Screen for Single Desks

- Curved or wave dividing screens with aluminium trim.
- Screen is bracketed to the outer edge of the desk top.
- Optional 4 way link post available (**ELP375**).

- For Fabric, suffix ...F
- For MFC, suffix ...MFC



Curved System Screen

	Group 1	Group 2	Group 3	Group 4	Group 5	Group 6	Group 7	MFC
ESSC20F - 1973w x 27d x 375h	£504	£516	£528	£540	£552	£564	£576	£460
ESSC18F - 1773w x 27d x 375h	£473	£485	£497	£509	£521	£533	£545	£435
ESSC16F - 1573w x 27d x 375h	£439	£451	£463	£475	£487	£499	£511	£407
ESSC14F - 1373w x 27d x 375h	£412	£424	£436	£448	£460	£472	£484	£378
ESSC12F - 1173w x 27d x 375h	£385	£397	£409	£421	£433	£445	£457	£354
ESSC10F - 973w x 27d x 375h	£357	£369	£381	£393	£405	£417	£429	£329
ESSC8F - 773w x 27d x 375h	£331	£343	£355	£367	£379	£391	£403	£307

Wave System Screen

ESSW20F - 1973w x 27d x 375h	£504	£516	£528	£540	£552	£564	£576	£460
ESSW18F - 1773w x 27d x 375h	£473	£485	£497	£509	£521	£533	£545	£435
ESSW16F - 1573w x 27d x 375h	£439	£451	£463	£475	£487	£499	£511	£407
ESSW14F - 1373w x 27d x 375h	£412	£424	£436	£448	£460	£472	£484	£378
ESSW12F - 1173w x 27d x 375h	£385	£397	£409	£421	£433	£445	£457	£354
ESSW10F - 973w x 27d x 375h	£357	£369	£381	£393	£405	£417	£429	£329
ESSW8F - 773w x 27d x 375h	£331	£343	£355	£367	£379	£391	£403	£307

Link Post

ELP375 - 4 Way | £72 |

Screens Acoustic for Single Desks

Lead Time: Standard (All products are manufactured to order and when 'Standard Lead Time' is quoted (7 – 10 days), this may vary dependant on volume ordered, factory capacity and distribution requirements at the time of ordering. For more information please contact your Dealer Business Manager or the Customer Services Team for clarification.)

Compatible: Reflex, Kassini, Optima Plus, Callisto, Windsor and Flexi

Fabric: Fully upholstered with pinnable surface available in Groups 1-7

Elite Desk Mounted Acoustic Screen for Single Desks

- Straight dividing screens faced with 6mm polyester fibre insulation board.
- Screen is bracketed to the outer edge of the desk top.
- Link post not required.
- Available as Hygiene Protection Screens and add-ons (see page 282-284).

• Class B certified in accordance with International Standards:

- ISO 354:2003
- ISO 11654:1997
- ISO 9613-1:1993



Straight Acoustic Screen

AESS16F

Straight Acoustic Screen

	Group 1	Group 2	Group 3	Group 4	Group 5	Group 6	Group 7
AESS20F - 1973w x 38d x 375h	£557	£569	£581	£593	£605	£617	£629
AESS18F - 1773w x 38d x 375h	£526	£538	£550	£562	£574	£586	£598
AESS16F - 1573w x 38d x 375h	£482	£494	£506	£518	£530	£542	£554
AESS14F - 1373w x 38d x 375h	£449	£461	£473	£485	£497	£509	£521
AESS12F - 1173w x 38d x 375h	£409	£421	£433	£445	£457	£469	£481
AESS10F - 973w x 38d x 375h	£386	£398	£410	£422	£434	£446	£458
AESS8F - 773w x 38d x 375h	£358	£370	£382	£394	£406	£418	£430



Screens Mid Return System Screens for Single Desks

Lead Time: Standard (All products are manufactured to order and when 'Standard Lead Time' is quoted (7 – 10 days), this may vary dependant on volume ordered, factory capacity and distribution requirements at the time of ordering. For more information please contact your Dealer Business Manager or the Customer Services Team for clarification.)

Compatible: Reflex, Kassini, Optima Plus, Callisto, Windsor and Flexi

Metalwork: Available in Anodised Silver (Standard), Black Graphite RAL 9004 and White RAL 9003

Fabric: Fully upholstered with pinnable surface available in Groups 1-7

Acrylic: Available in Blue, Green, Orange, Red, Frosted and Clear

MFC: Available in Ash, Autumn Cherry, Beech, Chester Oak, English Walnut, Grey, Grey Nebraska Oak, Laurentii Wenge, Natural Nebraska Oak and White

Elite Desk Mounted Mid Return System Screen for Single Desks

- Straight dividing screens with aluminium trim and optional management rail.
- Screen is fixed to the link post at one end and uses a metal blade between the desk tops to fix its position.
- 4 way link post required (ELP375).
- Available as Hygiene Protection Screens and add-ons (see page 282-284).

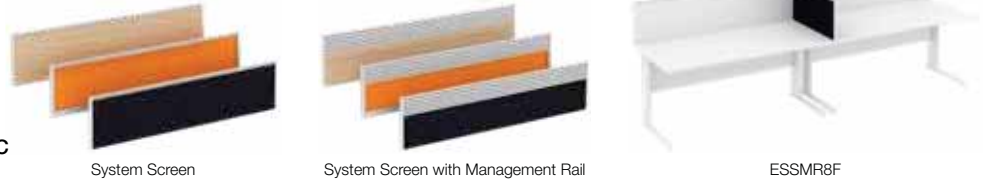

- For Fabric, suffix ...F
- For Acrylic, suffix ...A
- For MFC without Management Rail, suffix ...MFC
- For MFC with Management Rail, suffix .../MFC

Straight System Screen

	Group 1	Group 2	Group 3	Group 4	Group 5	Group 6	Group 7	Acrylic	MFC
ESSMR18... - 1773w x 27d x 375h	£419	£431	£443	£455	£467	£479	£491	£419	£382
ESSMR16... - 1573w x 27d x 375h	£385	£397	£409	£421	£433	£445	£457	£385	£351
ESSMR14... - 1373w x 27d x 375h	£357	£369	£381	£393	£405	£417	£429	£357	£324
ESSMR12... - 1173w x 27d x 375h	£325	£337	£349	£361	£373	£385	£397	£325	£295
ESSMR10... - 973w x 27d x 375h	£307	£319	£331	£343	£355	£367	£379	£307	£280
ESSMR8... - 773w x 27d x 375h	£295	£307	£319	£331	£343	£355	£367	£295	£263
ESSMR6... - 573w x 27d x 375h	£282	£294	£306	£318	£330	£342	£354	£282	£251

Straight System Screen with Management Rail

ESSMR18M... - 1773w x 27d x 375h	£559	£571	£583	£595	£607	£619	£631	£559	£507
ESSMR16M... - 1573w x 27d x 375h	£516	£528	£540	£552	£564	£576	£588	£516	£469
ESSMR14M... - 1373w x 27d x 375h	£454	£466	£478	£490	£502	£514	£526	£454	£431
ESSMR12M... - 1173w x 27d x 375h	£422	£434	£446	£458	£470	£482	£494	£422	£382
ESSMR10M... - 973w x 27d x 375h	£385	£397	£409	£421	£433	£445	£457	£385	£348
ESSMR8M... - 773w x 27d x 375h	£371	£383	£395	£407	£419	£431	£443	£371	£331
ESSMR6M... - 573w x 27d x 375h	£357	£369	£381	£393	£405	£417	£429	£357	£317

Link Post

ELP375 - 4 Way | £72 |

Elite Desk Mounted Mid Return System Screen for Single Desks

- Curved or wave dividing screens with aluminium trim.
- Screen is fixed to the link post at one end and uses a metal blade between the desk tops to fix its position.
- 4 way link post required (ELP375).

- For Fabric, suffix ...F
- For MFC, suffix ...MFC



Curved System Screen

	Group 1	Group 2	Group 3	Group 4	Group 5	Group 6	Group 7	MFC
ESSMRC18... - 1773w x 27d x 375h	£473	£485	£497	£509	£521	£533	£545	£435
ESSMRC16... - 1573w x 27d x 375h	£439	£451	£463	£475	£487	£499	£511	£407
ESSMRC14... - 1373w x 27d x 375h	£412	£424	£436	£448	£460	£472	£484	£378
ESSMRC12... - 1173w x 27d x 375h	£385	£397	£409	£421	£433	£445	£457	£354
ESSMRC10... - 973w x 27d x 375h	£357	£369	£381	£393	£405	£417	£429	£329
ESSMRC8... - 773w x 27d x 375h	£331	£343	£355	£367	£379	£391	£403	£307

Wave System Screen

ESSMRW18... - 1773w x 27d x 375h	£473	£485	£497	£509	£521	£533	£545	£435
ESSMRW16... - 1573w x 27d x 375h	£439	£451	£463	£475	£487	£499	£511	£407
ESSMRW14... - 1373w x 27d x 375h	£412	£424	£436	£448	£460	£472	£484	£378
ESSMRW12... - 1173w x 27d x 375h	£385	£397	£409	£421	£433	£445	£457	£354
ESSMRW10... - 973w x 27d x 375h	£357	£369	£381	£393	£405	£417	£429	£329
ESSMRW8... - 773w x 27d x 375h	£331	£343	£355	£367	£379	£391	£403	£307

Link Post

ELP375 - 4 Way | £72 |

Screens End Return System Screens for Single Desks

Lead Time: Standard (All products are manufactured to order and when 'Standard Lead Time' is quoted (7 – 10 days), this may vary dependant on volume ordered, factory capacity and distribution requirements at the time of ordering. For more information please contact your Dealer Business Manager or the Customer Services Team for clarification.)

Compatible: Reflex, Kassini, Optima Plus, Callisto and Flexi

Metalwork: Available in Anodised Silver (Standard), Black Graphite RAL 9004 and White RAL 9003

Fabric: Fully upholstered with pinnable surface available in Groups 1-7

Acrylic: Available in Blue, Green, Orange, Red, Frosted and Clear

MFC: Available in Ash, Autumn Cherry, Beech, Chester Oak, English Walnut, Grey, Grey Nebraska Oak, Laurentii Wenge, Natural Nebraska Oak and White

Elite Desk Mounted End Return System Screen for Single Desks

- Straight dividing screens with aluminium trim and optional management rail.
- Screen is fixed to the link post at one end and is bracketed to the desk tops at the other.
- 4 way link post required (ELP375).
- Available as Hygiene Protection Screens and add-ons (see page 282-284).

- For Fabric, suffix ...F
- For Acrylic, suffix ...A
- For MFC without Management Rail, suffix ...MFC
- For MFC with Management Rail, suffix .../MFC



Straight System Screen

	Group 1	Group 2	Group 3	Group 4	Group 5	Group 6	Group 7	Acrylic	MFC
ESSER18... - 1773w x 27d x 375h	£419	£431	£443	£455	£467	£479	£491	£419	£382
ESSER16... - 1573w x 27d x 375h	£385	£397	£409	£421	£433	£445	£457	£385	£351
ESSER14... - 1373w x 27d x 375h	£357	£369	£381	£393	£405	£417	£429	£357	£324
ESSER12... - 1173w x 27d x 375h	£325	£337	£349	£361	£373	£385	£397	£325	£295
ESSER10... - 973w x 27d x 375h	£307	£319	£331	£343	£355	£367	£379	£307	£280
ESSER8... - 773w x 27d x 375h	£295	£307	£319	£331	£343	£355	£367	£295	£263
ESSER6... - 573w x 27d x 375h	£282	£294	£306	£318	£330	£342	£354	£282	£251

Straight System Screen with Management Rail

ESSER18M... - 1773w x 27d x 375h	£559	£571	£583	£595	£607	£619	£631	£559	£507
ESSER16M... - 1573w x 27d x 375h	£516	£528	£540	£552	£564	£576	£588	£516	£469
ESSER14M... - 1373w x 27d x 375h	£454	£466	£478	£490	£502	£514	£526	£454	£431
ESSER12M... - 1173w x 27d x 375h	£422	£434	£446	£458	£470	£482	£494	£422	£382
ESSER10M... - 973w x 27d x 375h	£385	£397	£409	£421	£433	£445	£457	£385	£348
ESSER8M... - 773w x 27d x 375h	£371	£383	£395	£407	£419	£431	£443	£371	£331
ESSER6M... - 573w x 27d x 375h	£357	£369	£381	£393	£405	£417	£429	£357	£317

Link Post

ELP375 - 4 Way | £72 |

Elite Desk Mounted End Return System Screen for Single Desks

- Curved or wave dividing screens with aluminium trim.
- Screen is fixed to the link post at one end and is bracketed to the desk tops at the other.
- 4 way link post required (ELP375).

- For Fabric, suffix ...F
- For MFC, suffix ...MFC



Curved System Screen

	Group 1	Group 2	Group 3	Group 4	Group 5	Group 6	Group 7	MFC
ESSERC18... - 1773w x 27d x 375h	£473	£485	£497	£509	£521	£533	£545	£435
ESSERC16... - 1573w x 27d x 375h	£439	£451	£463	£475	£487	£499	£511	£407
ESSERC14... - 1373w x 27d x 375h	£412	£424	£436	£448	£460	£472	£484	£378
ESSERC12... - 1173w x 27d x 375h	£385	£397	£409	£421	£433	£445	£457	£354
ESSERC10... - 973w x 27d x 375h	£357	£369	£381	£393	£405	£417	£429	£329
ESSERC8... - 773w x 27d x 375h	£331	£343	£355	£367	£379	£391	£403	£307

Wave System Screen

ESSERW18... - 1773w x 27d x 375h	£473	£485	£497	£509	£521	£533	£545	£435
ESSERW16... - 1573w x 27d x 375h	£439	£451	£463	£475	£487	£499	£511	£407
ESSERW14... - 1373w x 27d x 375h	£412	£424	£436	£448	£460	£472	£484	£378
ESSERW12... - 1173w x 27d x 375h	£385	£397	£409	£421	£433	£445	£457	£354
ESSERW10... - 973w x 27d x 375h	£357	£369	£381	£393	£405	£417	£429	£329
ESSERW8... - 773w x 27d x 375h	£331	£343	£355	£367	£379	£391	£403	£307

Link Post

ELP375 - 4 Way | £72 |

Screens 120 Degree System Screens for 120 Degree Workstations

Lead Time: Standard (All products are manufactured to order and when 'Standard Lead Time' is quoted (7 – 10 days), this may vary dependant on volume ordered, factory capacity and distribution requirements at the time of ordering. For more information please contact your Dealer Business Manager or the Customer Services Team for clarification.)

Compatible: Kassini, Optima Plus, Callisto and Flexi

Metalwork: Available in Anodised Silver (Standard), Black Graphite RAL 9004 and White RAL 9003

Fabric: Fully upholstered with pinnable surface available in Groups 1-7

Acrylic: Available in Blue, Green, Orange, Red, Frosted and Clear

MFC: Available in Ash, Autumn Cherry, Beech, Chester Oak, English Walnut, Grey, Grey Nebraska Oak, Laurentii Wenge, Natural Nebraska Oak and White

Elite Desk Mounted System Screen for 120 Degree Workstations

- Straight dividing screens with aluminium trim and optional management rail.
- Screen is fixed to the link post at one end and is bracketed to the leg frame at the other.

- 3 way link post required (ELP375/120).

- Available as Hygiene Protection

Screens and add-ons (see page 282-284).

- For Fabric, suffix ...F
- For Acrylic, suffix ...A
- For MFC without Management Rail, suffix ...MFC
- For MFC with Management Rail, suffix .../MFC



Straight System Screen

	Group 1	Group 2	Group 3	Group 4	Group 5	Group 6	Group 7	Acrylic	MFC
ESS120/12... - 1179w x 27d x 375h	£325	£337	£349	£361	£373	£385	£397	£325	£295
ESS120/10... - 979w x 27d x 375h	£307	£319	£331	£343	£355	£367	£379	£307	£280

Straight System Screen with Management Rail

ESS120/12M... - 1179w x 27d x 375h	£422	£434	£446	£458	£470	£482	£494	£422	£382
ESS120/10M... - 979w x 27d x 375h	£385	£397	£409	£421	£433	£445	£457	£385	£348

Link Post

ELP375/120 - 3 Way	£72
---------------------------	-----

Elite Desk Mounted System Screen for 120 Degree Workstations

- Curved and wave dividing screens with aluminium trim.
- Screen is fixed to the link post at one end and is bracketed to the leg frame at the other.

- 3 way link post required (ELP375/120).

- For Fabric, suffix ...F
- For MFC, suffix ...MFC



Curved System Screen

	Group 1	Group 2	Group 3	Group 4	Group 5	Group 6	Group 7	MFC
ESSC120/12... - 1179w x 27d x 375h	£385	£397	£409	£421	£433	£445	£457	£354
ESSC120/10... - 979w x 27d x 375h	£357	£369	£381	£393	£405	£417	£429	£329

Wave System Screen

ESSW120/12... - 1179w x 27d x 375h	£385	£397	£409	£421	£433	£445	£457	£354
ESSW120/10... - 979w x 27d x 375h	£357	£369	£381	£393	£405	£417	£429	£329

Link Post

ELP375/120 - 3 Way	£72
---------------------------	-----

Screens Ped Return System Screens for Single Desks

Lead Time: Standard (All products are manufactured to order and when 'Standard Lead Time' is quoted (7 – 10 days), this may vary dependant on volume ordered, factory capacity and distribution requirements at the time of ordering. For more information please contact your Dealer Business Manager or the Customer Services Team for clarification.)

Compatible: Kassini, Optima Plus, Reflex, Callisto and Flexi

Metalwork: Available in Anodised Silver (Standard), Black Graphite RAL 9004 and White RAL 9003

Fabric: Fully upholstered with pinnable surface available in Groups 1-7

Acrylic: Available in Blue, Green, Orange, Red, Frosted and Clear

MFC: Available in Ash, Autumn Cherry, Beech, Chester Oak, English Walnut, Grey, Grey Nebraska Oak, Laurentii Wenge, Natural Nebraska Oak and White

Elite Desk Mounted Ped Return System Screen for Single Desks

- Straight dividing screens with aluminium trim and optional management rail.
- Screen is fixed to the link post at one end and is bracketed to the desk tops at the other before the pedestal.
- 4 way link post required (ELP375).

- For Fabric, suffix ...F
- For Acrylic, suffix ...A
- For MFC without Management Rail, suffix ...MFC
- For MFC with Management Rail, suffix .../MFC



System Screen



System Screen with Management Rail



ESSPR16F

Straight System Screen

	Group 1	Group 2	Group 3	Group 4	Group 5	Group 6	Group 7	Acrylic	MFC
ESSPR16... - 1592w x 27d x 375h	£385	£397	£409	£421	£433	£445	£457	£385	£351

Straight System Screen with Management Rail

ESSPR16M... - 1592w x 27d x 375h	£516	£528	£540	£552	£564	£576	£588	£516	£469
---	------	------	------	------	------	------	------	------	------

Link Post

ELP375 - 4 Way	£72
-----------------------	-----

Elite Desk Mounted Ped Return System Screen for Single Desks

- Curved and wave dividing screens with aluminium trim.
- Screen is fixed to the link post at one end and is bracketed to the desk tops at the other before the pedestal.
- 4 way link post required (ELP375).

- For Fabric, suffix ...F
- For MFC, suffix ...MFC



Curved System Screen



Wave System Screen



ESSPRC16F

Curved System Screen

	Group 1	Group 2	Group 3	Group 4	Group 5	Group 6	Group 7	MFC
ESSPRC16... - 1592w x 27d x 375h	£439	£451	£463	£475	£487	£499	£511	£407

Wave System Screen

ESSPRW16... - 1592w x 27d x 375h	£439	£451	£463	£475	£487	£499	£511	£407
---	------	------	------	------	------	------	------	------

Link Post

ELP375 - 4 Way	£72
-----------------------	-----

Screens Standard and 120 Degree Contract Screens for Single Workstations

Lead Time: Standard (All products are manufactured to order and when 'Standard Lead Time' is quoted (7 – 10 days), this may vary dependant on volume ordered, factory capacity and distribution requirements at the time of ordering. For more information please contact your Dealer Business Manager or the Customer Services Team for clarification.)

Compatible: Reflex, Kassini, Optima Plus, Callisto, Windsor and Flexi

Fabric: Fully upholstered with pinnable surface available in Groups 1-7

Elite Desk Mounted Contract Screen for Single Desks

- Straight, curved and wave dividing screens.
- Screen is bracketed to the outer edge of the desk top.
- Link post not required.
- Available as Hygiene Protection Screens and add-ons (see page 282-284).

- For Back to Back Desking, use standard code
- For Stand Alone Desking, suffix .../X



Straight, Curved and Wave Contract Screen

ECS16F

Straight Contract Screen

ECS18F... - 1770w x 27d x 375h	_____
ECS16F... - 1570w x 27d x 375h	_____
ECS14F... - 1370w x 27d x 375h	_____
ECS12F... - 1170w x 27d x 375h	_____
ECS10F... - 970w x 27d x 375h	_____
ECS8F... - 770w x 27d x 375h	_____

Group 1	Group 2	Group 3	Group 4	Group 5	Group 6	Group 7
£270	£282	£294	£306	£318	£330	£342
£261	£273	£285	£297	£309	£321	£333
£248	£260	£272	£284	£296	£308	£320
£236	£248	£260	£272	£284	£296	£308
£223	£235	£247	£259	£271	£283	£295
£213	£225	£237	£249	£261	£273	£285

Curved Contract Screen

ECSC18F... - 1770w x 27d x 375h	_____
ECSC16F... - 1570w x 27d x 375h	_____
ECSC14F... - 1370w x 27d x 375h	_____
ECSC12F... - 1170w x 27d x 375h	_____
ECSC10F... - 970w x 27d x 375h	_____
ECSC8F... - 770w x 27d x 375h	_____

£326	£338	£350	£362	£374	£386	£398
£314	£326	£338	£350	£362	£374	£386
£300	£312	£324	£336	£348	£360	£372
£289	£301	£313	£325	£337	£349	£361
£280	£292	£304	£316	£328	£340	£352
£270	£282	£294	£306	£318	£330	£342

Wave Contract Screen

ECSW18F... - 1770w x 27d x 375h	_____
ECSW16F... - 1570w x 27d x 375h	_____
ECSW14F... - 1370w x 27d x 375h	_____
ECSW12F... - 1170w x 27d x 375h	_____
ECSW10F... - 970w x 27d x 375h	_____
ECSW8F... - 770w x 27d x 375h	_____

£326	£338	£350	£362	£374	£386	£398
£314	£326	£338	£350	£362	£374	£386
£300	£312	£324	£336	£348	£360	£372
£289	£301	£313	£325	£337	£349	£361
£280	£292	£304	£316	£328	£340	£352
£270	£282	£294	£306	£318	£330	£342

Elite Desk Mounted 120 Degree Contract Screen for 120 Degree Workstations

- Straight, curved and wave dividing screens.
- Screen is bracketed to the outer edge of the desk tops.
- Link post not required.
- Available as Hygiene Protection Screens and add-ons (see page 282-284).

- For Back to Back Desking, use standard code
- For Stand Alone Desking, suffix .../X



Straight, Curved and Wave Contract Screen

ECS120/12F

Straight Contract Screen

ECS120/12F... - 1185w x 27d x 375h	_____
ECS120/10F... - 985w x 27d x 375h	_____

Group 1	Group 2	Group 3	Group 4	Group 5	Group 6	Group 7
£236	£248	£260	£272	£284	£296	£308
£223	£235	£247	£259	£271	£283	£295

Curved Contract Screen

ECSC120/12F... - 1185w x 27d x 375h	_____
ECSC120/10F... - 985w x 27d x 375h	_____

£289	£301	£313	£325	£337	£349	£361
£280	£292	£304	£316	£328	£340	£352

Wave Contract Screen

ECSW120/12F... - 1185w x 27d x 375h	_____
ECSW120/10F... - 985w x 27d x 375h	_____

£289	£301	£313	£325	£337	£349	£361
£280	£292	£304	£316	£328	£340	£352

Screens Ped Return Contract Screens for Single Workstations and Accessories

Lead Time: Standard (All products are manufactured to order and when 'Standard Lead Time' is quoted (7 – 10 days), this may vary dependant on volume ordered, factory capacity and distribution requirements at the time of ordering. For more information please contact your Dealer Business Manager or the Customer Services Team for clarification.)

Compatible: Kassini, Optima Plus, Callisto and Flexi

Fabric: Fully upholstered with pinnable surface available in Groups 1-7

Elite Desk Mounted Ped Return Contract Screen for Single Desks

- Straight, curved and wave dividing screens.
- Screen is bracketed to the outer edge of the desk tops before the pedestal.
- Link post not required.
- Available as Hygiene Protection Screens and add-ons (see page 282-284).

- For Back to Back Desking, use standard code
- For Stand Alone Desking, suffix .../X



Straight, Curved and Wave Contract Screen

ECSPR16F

Straight Contract Screen

ECSPR18F... - 1790w x 27d x 375h	_____
ECSPR16F... - 1590w x 27d x 375h	_____
ECSPR14F... - 1390w x 27d x 375h	_____
ECSPR12F... - 1190w x 27d x 375h	_____
ECSPR10F... - 990w x 27d x 375h	_____

Group 1	Group 2	Group 3	Group 4	Group 5	Group 6	Group 7
---------	---------	---------	---------	---------	---------	---------

£270	£282	£294	£306	£318	£330	£342
£261	£273	£285	£297	£309	£321	£333
£248	£260	£272	£284	£296	£308	£320
£236	£248	£260	£272	£284	£296	£308
£223	£235	£247	£259	£271	£283	£295

Curved Contract Screen

ECSPRC18F... - 1790w x 27d x 375h	_____
ECSPRC16F... - 1590w x 27d x 375h	_____
ECSPRC14F... - 1390w x 27d x 375h	_____
ECSPRC12F... - 1190w x 27d x 375h	_____
ECSPRC10F... - 990w x 27d x 375h	_____

£326	£338	£350	£362	£374	£386	£398
£314	£326	£338	£350	£362	£374	£386
£300	£312	£324	£336	£348	£360	£372
£289	£301	£313	£325	£337	£349	£361
£280	£292	£304	£316	£328	£340	£352

Wave Contract Screen

ECSPRW18F... - 1790w x 27d x 375h	_____
ECSPRW16F... - 1590w x 27d x 375h	_____
ECSPRW14F... - 1390w x 27d x 375h	_____
ECSPRW12F... - 1190w x 27d x 375h	_____
ECSPRW10F... - 990w x 27d x 375h	_____

£326	£338	£350	£362	£374	£386	£398
£314	£326	£338	£350	£362	£374	£386
£300	£312	£324	£336	£348	£360	£372
£289	£301	£313	£325	£337	£349	£361
£280	£292	£304	£316	£328	£340	£352



CSNP/S

Contract Screen Name Plate

- Fabricated steel. • Compatible with straight contract screens only.
- Removable magnetic perspex front.

Metalwork

CSNP/S - Silver - 210w x 38d x 45h	_____	£70
CSNP/B - Black - 210w x 38d x 45h	_____	£70
CSNP/W - White - 210w x 38d x 45h	_____	£70



CSVPT/S

Contract Screen Vertical A4 Paper Tray

- Fabricated steel. • Compatible with straight contract screens only.
- Supplied with 3 magnets.

Metalwork

CSVPT/S - Silver - 330w x 90d x 235h	_____	£80
CSVPT/B - Black - 330w x 90d x 235h	_____	£80
CSVPT/W - White - 330w x 90d x 235h	_____	£80

Screens Acrylic Hygiene Protection Screens for Single Desks

Lead Time: Standard (All products are manufactured to order and when 'Standard Lead Time' is quoted (7 – 10 days), this may vary dependant on volume ordered, factory capacity and distribution requirements at the time of ordering. For more information please contact your Dealer Business Manager or the Customer Services Team for clarification.)

Compatible: Reflex, Kassini, Optima Plus, Callisto, and Flexi

Acrylic: Clear

Metalwork: Fixing Brackets and Freestanding Feet supplied in Silver RAL 9006 (Standard) - Optional Black Graphite RAL 9004 and White RAL 9003



Acrylic Illustrated in Blue



EHPS16
Acrylic Illustrated in Blue



EHPS16/O
Acrylic Illustrated
in Blue



Elite Desk Mounted Acrylic Hygiene Protection Screen for Single Desks

- Rectangular acrylic dividing screens supplied with fixing brackets.
- Screen is clamped to the desktop.
- Brackets supplied in Silver RAL 9006 as standard.
- For a central opening of 400w x 60h, suffix **.../O**.

Elite Desk Mounted Screen

	Price
EHPS20 - 1973w x 5d x 700h	£367
EHPS18 - 1773w x 5d x 700h	£342
EHPS16 - 1573w x 5d x 700h	£316
EHPS14 - 1373w x 5d x 700h	£294
EHPS12 - 1173w x 5d x 700h	£265
EHPS10 - 973w x 5d x 700h	£238
EHPS8 - 773w x 5d x 700h	£214



EHPSMR8
Acrylic Illustrated in Blue



Elite Desk Mounted Mid Return Acrylic Hygiene Protection Screen for Single Desks

- Rectangular acrylic dividing screens supplied with 1x freestanding foot and 1x fixing bracket.
- Screen is clamped to the desktop.
- Freestanding feet and brackets supplied in Silver RAL 9006 as standard.

Elite Desk Mounted Mid Return Screen

	Price
EHPSMR8 - 780w x 5d x 700h	£248
EHPSMR7 - 680w x 5d x 700h	£235
EHPSMR6 - 580w x 5d x 700h	£222

Screens Acrylic Hygiene Protection Screens for Single Desks

Lead Time: Standard (All products are manufactured to order and when 'Standard Lead Time' is quoted (7 – 10 days), this may vary dependant on volume ordered, factory capacity and distribution requirements at the time of ordering. For more information please contact your Dealer Business Manager or the Customer Services Team for clarification.)

Compatible: Reflex, Kassini, Optima Plus, Callisto, and Flexi

Acrylic: Clear

Metalwork: Fixing Brackets and Freestanding Feet supplied in Silver RAL 9006 (Standard) - Optional Black Graphite RAL 9004 and White RAL 9003



EHPSE8
Acrylic Illustrated in Blue



Elite Desk Mounted End Return Acrylic Hygiene Protection Screen for Single Desks

- Rectangular acrylic dividing screens supplied with fixing brackets.
- Screen is clamped to the desktop.
- Brackets supplied in Silver RAL 9006 as standard.

Elite Desk Mounted End Return Screen

		Price
EHPSE8	- 780w x 5d x 700h	£248
EHPSE7	- 680w x 5d x 700h	£235
EHPSE6	- 580w x 5d x 700h	£222



ESS16/HPS
Acrylic Illustrated in Blue



Elite Desk Mounted Acrylic Hygiene Protection Screen for Single Desks with Screens

- Rectangular acrylic dividing screens supplied with brackets.
- Screen is bracketed to the existing screen frame.
- Brackets supplied in Silver RAL 9006 as standard.
- Screens compatible with Non-Elite Desk Mounted Screens available.

Addition for 27mm Elite Desk Mounted System Screen

		Price
ESS20/HPS	- 1973w x 5d x 325h	£224
ESS18/HPS	- 1773w x 5d x 325h	£212
ESS16/HPS	- 1573w x 5d x 325h	£199
ESS14/HPS	- 1373w x 5d x 325h	£189
ESS12/HPS	- 1173w x 5d x 325h	£171
ESS10/HPS	- 973w x 5d x 325h	£158
ESS8/HPS	- 773w x 5d x 325h	£145



Addition for 38mm Elite Desk Mounted Acoustic Screen

AESS20F/HPS	- 1973w x 5d x 325h	£224
AESS18F/HPS	- 1773w x 5d x 325h	£212
AESS16F/HPS	- 1573w x 5d x 325h	£199
AESS14F/HPS	- 1373w x 5d x 325h	£189
AESS12F/HPS	- 1173w x 5d x 325h	£171
AESS10F/HPS	- 973w x 5d x 325h	£158
AESS8F/HPS	- 773w x 5d x 325h	£145



Addition for 27mm Elite Desk Mounted Contract Screen

ECS18F/HPS	- 1770w x 5d x 325h	£212
ECS16F/HPS	- 1570w x 5d x 325h	£199
ECS14F/HPS	- 1370w x 5d x 325h	£189
ECS12F/HPS	- 1170w x 5d x 325h	£171
ECS10F/HPS	- 970w x 5d x 325h	£158
ECS8F/HPS	- 770w x 5d x 325h	£145



Addition for Non-Elite Desk Mounted Screens with a thickness of 18mm – 40mm
Supplied with adjustable brackets

NES18/HPS	- 1773w x 5d x 325h	£212
NES16/HPS	- 1573w x 5d x 325h	£199
NES14/HPS	- 1373w x 5d x 325h	£189
NES12/HPS	- 1173w x 5d x 325h	£171
NES10/HPS	- 973w x 5d x 325h	£158
NES8/HPS	- 773w x 5d x 325h	£145

Screens Acrylic Hygiene Protection Screens for 120 Degree Workstations

Lead Time: Standard (All products are manufactured to order and when 'Standard Lead Time' is quoted (7 – 10 days), this may vary dependant on volume ordered, factory capacity and distribution requirements at the time of ordering. For more information please contact your Dealer Business Manager or the Customer Services Team for clarification.)

Compatible: Reflex, Kassini, Optima Plus, Callisto, and Flexi

Acrylic: Clear

Metalwork: Fixing Brackets and Freestanding Feet supplied in Silver RAL 9006 (Standard) - Optional Black Graphite RAL 9004 and White RAL 9003



EHPS120/12
Acrylic Illustrated in Blue



EHPS120/12/O
Acrylic Illustrated
in Blue



Elite Desk Mounted Acrylic Hygiene Protection Screen for 120 Degree Workstations

- Rectangular acrylic dividing screens supplied with fixing brackets.
- Screen is clamped to the desktop.
- Brackets supplied in Silver RAL 9006 as standard.
- For a central opening of 400w x 60h, suffix **.../O**.

Elite Desk Mounted System Screen

EHPS120/12 - 1179w x 5d x 700h _____

EHPS120/10 - 979w x 5d x 700h _____

Price

£268

£243



ESS120/12/HPS
Acrylic Illustrated in Blue



Elite Desk Mounted Acrylic Hygiene Protection Screen for 120 Degree Workstations with Screens

- Rectangular acrylic dividing screens supplied with brackets.
- Screen is bracketed to the existing screen frame.
- Brackets supplied in Silver RAL 9006 as standard.
- Screens compatible with Non-Elite Desk Mounted Screens available.

Addition for 27mm Elite Desk Mounted System Screen

ESS120/12/HPS - 1179w x 5d x 325h _____

ESS120/10/HPS - 979w x 5d x 325h _____

Price

£184

£163



Addition for 27mm Elite Desk Mounted Contract Screen

ECS120/12/HPS - 1179w x 5d x 325h _____

ECS120/10/HPS - 979w x 5d x 325h _____

£184

£163



Addition for Non-Elite Desk Mounted Screens with a thickness of 18mm – 40mm
Supplied with adjustable brackets

NES120/12/HPS - 1179w x 5d x 325h _____

NES120/10/HPS - 979w x 5d x 325h _____

£184

£163

Screens Desktop / Countertop Acrylic Hygiene Protection Screens

Lead Time: Standard (All products are manufactured to order and when 'Standard Lead Time' is quoted (7 – 10 days), this may vary dependant on volume ordered, factory capacity and distribution requirements at the time of ordering. For more information please contact your Dealer Business Manager or the Customer Services Team for clarification.)

Acrylic: Clear

Metalwork: Fixing Brackets and Freestanding Feet supplied in Silver RAL 9006 (Standard) - Optional Black Graphite RAL 9004 and White RAL 9003

Desk / Countertop Mounted Acrylic Hygiene Protection Screen

- Single acrylic screen with 4 upstands.

- For Standard Screen, use code
- For Standard Screen with Opening, suffix .../O



EAS20/8



EAS20/8/O

Acrylic Hygiene Protection Screen

	1-10 Units	11-25 Units	26-50 Units	51+ Units
EAS18/10 - 1800w x 5d x 1000h	£340	£326	£314	£299
EAS18/9 - 1800w x 5d x 900h	£306	£294	£281	£268
EAS20/8 - 2000w x 5d x 800h	£301	£291	£278	£265
EAS18/8 - 1800w x 5d x 800h	£273	£260	£250	£240
EAS20/7 - 2000w x 5d x 700h	£265	£253	£243	£233
EAS18/7 - 1800w x 5d x 700h	£238	£230	£219	£209
EAS20/6 - 2000w x 5d x 600h	£227	£217	£209	£199
EAS18/6 - 1800w x 5d x 600h	£204	£197	£189	£179



Screens Desktop / Countertop Acrylic Hygiene Protection Screens

Lead Time: Standard (All products are manufactured to order and when 'Standard Lead Time' is quoted (7 – 10 days), this may vary dependant on volume ordered, factory capacity and distribution requirements at the time of ordering. For more information please contact your Dealer Business Manager or the Customer Services Team for clarification.)

Acrylic: Clear

Metalwork: Fixing Brackets and Freestanding Feet supplied in Silver RAL 9006 (Standard) - Optional Black Graphite RAL 9004 and White RAL 9003

Desk / Countertop Mounted Acrylic Hygiene Protection Screen

- Single acrylic screen with 2 upstands.

- For Standard Screen, use code
- For Standard Screen with Opening, suffix .../O



EAS16/8



EAS16/8/O

Acrylic Hygiene Protection Screen

	1-10 Units	11-25 Units	26-50 Units	51+ Units
EAS16/10 - 1600w x 5d x 1000h	£301	£291	£278	£265
EAS14/10 - 1400w x 5d x 1000h	£265	£253	£243	£233
EAS12/10 - 1200w x 5d x 1000h	£227	£217	£209	£199
EAS10/10 - 1000w x 5d x 1000h	£189	£182	£173	£166
EAS9/10 - 900w x 5d x 1000h	£182	£173	£166	£161
EAS8/10 - 800w x 5d x 1000h	£161	£156	£148	£143
EAS7/10 - 700w x 5d x 1000h	£141	£136	£131	£125
EAS6/10 - 600w x 5d x 1000h	£120	£117	£112	£107
EAS16/9 - 1600w x 5d x 900h	£273	£260	£250	£240
EAS14/9 - 1400w x 5d x 900h	£238	£230	£219	£209
EAS12/9 - 1200w x 5d x 900h	£204	£197	£189	£179
EAS10/9 - 1000w x 5d x 900h	£171	£163	£156	£151
EAS9/9 - 900w x 5d x 900h	£163	£156	£151	£143
EAS8/9 - 800w x 5d x 900h	£146	£141	£133	£128
EAS7/9 - 700w x 5d x 900h	£128	£122	£117	£112
EAS6/9 - 600w x 5d x 900h	£110	£105	£100	£97
EAS16/8 - 1600w x 5d x 800h	£243	£233	£222	£212
EAS14/8 - 1400w x 5d x 800h	£212	£204	£194	£187
EAS12/8 - 1200w x 5d x 800h	£182	£173	£166	£161
EAS10/8 - 1000w x 5d x 800h	£151	£146	£138	£133
EAS9/8 - 900w x 5d x 800h	£146	£141	£133	£128
EAS8/8 - 800w x 5d x 800h	£131	£125	£120	£112
EAS7/8 - 700w x 5d x 800h	£112	£107	£105	£100
EAS6/8 - 600w x 5d x 800h	£97	£92	£90	£85
EAS16/7 - 1600w x 5d x 700h	£212	£204	£194	£187
EAS14/7 - 1400w x 5d x 700h	£187	£179	£171	£163
EAS12/7 - 1200w x 5d x 700h	£158	£153	£146	£141
EAS10/7 - 1000w x 5d x 700h	£133	£128	£122	£117
EAS9/7 - 900w x 5d x 700h	£128	£122	£117	£112
EAS8/7 - 800w x 5d x 700h	£112	£107	£105	£100
EAS7/7 - 700w x 5d x 700h	£100	£95	£92	£87
EAS6/7 - 600w x 5d x 700h	£85	£82	£80	£74
EAS16/6 - 1600w x 5d x 600h	£182	£173	£166	£161
EAS14/6 - 1400w x 5d x 600h	£158	£153	£146	£141
EAS12/6 - 1200w x 5d x 600h	£136	£131	£125	£120
EAS10/6 - 1000w x 5d x 600h	£112	£110	£105	£100
EAS9/6 - 900w x 5d x 600h	£110	£105	£100	£97
EAS8/6 - 800w x 5d x 600h	£97	£92	£90	£85
EAS7/6 - 700w x 5d x 600h	£85	£82	£80	£74
EAS6/6 - 600w x 5d x 600h	£71	£69	£66	£64

Screens Counter Top Mounted Acrylic Hygiene Protection Screens

Lead Time: Standard (All products are manufactured to order and when 'Standard Lead Time' is quoted (7 – 10 days), this may vary dependant on volume ordered, factory capacity and distribution requirements at the time of ordering. For more information please contact your Dealer Business Manager or the Customer Services Team for clarification.)

Acrylic: Clear

Metalwork: Fixing Brackets and Freestanding Feet supplied in Silver RAL 9006 (Standard) - Optional Black Graphite RAL 9004 and White RAL 9003

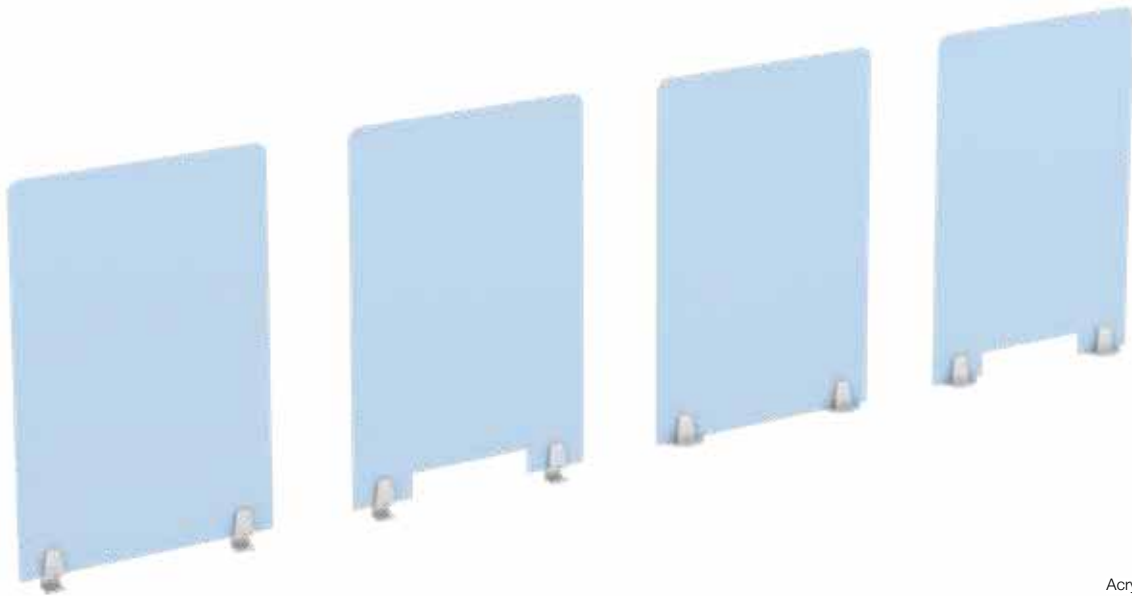

Acrylic Illustrated in Blue



EHPST10/9F
Acrylic Illustrated in Blue

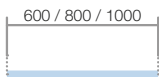

Elite Desk Mounted Acrylic Hygiene Protection Screen for Counter Tops

- Rectangular acrylic dividing screens supplied with freestanding feet or fixing brackets.
- Freestanding screen supplied with self adhesive pads.
- The bracketed version is fixed to 25mm desktops only.
- Freestanding feet and brackets supplied in Silver RAL 9006 as standard.

Freestanding Desk Mounted Screen

Supplied with Self Adhesive Pads for Desktop Adhesion

EHPST10/9F	- 1000w x 5d x 900h	_____	£243
EHPST8/9F	- 800w x 5d x 900h	_____	£219
EHPST6/9F	- 600w x 5d x 900h	_____	£197

Price

Bracketed Desk Mounted Screen

EHPST10/9C	- 1000w x 5d x 900h	_____	£243
EHPST8/9C	- 800w x 5d x 900h	_____	£219
EHPST6/9C	- 600w x 5d x 900h	_____	£197

£243
£219
£197



EHPST10/9F/O
Illustrated in Blue

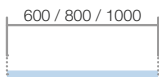

Elite Desk Mounted Acrylic Protection Screen for Counter Tops with Opening

- Rectangular acrylic dividing screens supplied with freestanding feet or fixing brackets.
- 300 / 400w x 60h opening is at the base of the front edge.
- Freestanding screen supplied with self adhesive pads.
- The bracketed version is fixed to 25mm desktops only.
- Freestanding feet and brackets supplied in Silver RAL 9006 as standard.

Freestanding Desk Mounted Screen with Opening

Supplied with Self Adhesive Pads for Desktop Adhesion

EHPST10/9F/O	- 1000w x 5d x 900h (400w x 60h Opening)	_____	£243
EHPST8/9F/O	- 800w x 5d x 900h (400w x 60h Opening)	_____	£219
EHPST6/9F/O	- 600w x 5d x 900h (300w x 60h Opening)	_____	£197

Price

Bracketed Desk Mounted Screen with Opening

EHPST10/9C/O	- 1000w x 5d x 900h (400w x 60h Opening)	_____	£243
EHPST8/9C/O	- 800w x 5d x 900h (400w x 60h Opening)	_____	£219
EHPST6/9C/O	- 600w x 5d x 900h (300w x 60h Opening)	_____	£197

£243
£219
£197

Screens Counter Top Mounted Acrylic Hygiene Protection Screens with 90 Degree Returns

Lead Time: Standard (All products are manufactured to order and when 'Standard Lead Time' is quoted (7 – 10 days), this may vary dependant on volume ordered, factory capacity and distribution requirements at the time of ordering. For more information please contact your Dealer Business Manager or the Customer Services Team for clarification.)

Acrylic: Clear

Metalwork: Fixing Brackets and Freestanding Feet supplied in Silver RAL 9006 (Standard) - Optional Black Graphite RAL 9004 and White RAL 9003



Acrylic Illustrated in Blue



EHP SCT10/90R5F
Acrylic Illustrated in Blue

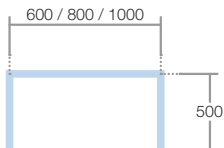

Elite Desk Mounted Acrylic Hygiene Protection Screen for Counter Tops with 90 Degree Returns

- Rectangular acrylic dividing screens supplied with freestanding feet or fixing brackets with 500w straight returns at 90 degrees.
- The freestanding version is freestanding on the desktop.
- The bracketed version is fixed to 25mm desktops only.
- Freestanding feet and brackets supplied in Silver RAL 9006 as standard.

Freestanding Desk Mounted Screen with 90 Degree Returns

Model	Dimensions	Price
EHP SCT10/90R5F	- 1000w x 500d x 750h	£418
EHP SCT8/90R5F	- 800w x 500d x 750h	£393
EHP SCT6/90R5F	- 600w x 500d x 750h	£367

Bracketed Desk Mounted Screen with 90 Degree Returns

Model	Dimensions	Price
EHP SCT10/90R5C	- 1000w x 500d x 750h	£418
EHP SCT8/90R5C	- 800w x 500d x 750h	£393
EHP SCT6/90R5C	- 600w x 500d x 750h	£367



EHP SCT10/90R5F/O
Acrylic Illustrated in Blue

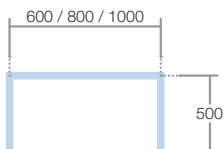

Elite Desk Mounted Acrylic Hygiene Protection Screen for Counter Tops with 90 Degree Returns and Opening

- Rectangular acrylic dividing screens supplied with freestanding feet or fixing brackets with 500w straight returns at 90 degrees.
- 300 / 400w x 60h opening is at the base of the front edge.
- The freestanding version is freestanding on the desktop.
- The bracketed version is fixed to 25mm desktops only.
- Freestanding feet and brackets supplied in Silver RAL 9006 as standard.

Freestanding Desk Mounted Screen with 90 Degree Returns and Opening

Model	Dimensions	Price
EHP SCT10/90R5F/O	- 1000w x 500d x 750h (400w x 60h Opening)	£418
EHP SCT8/90R5F/O	- 800w x 500d x 750h (400w x 60h Opening)	£393
EHP SCT6/90R5F/O	- 600w x 500d x 750h (300w x 60h Opening)	£367

Bracketed Desk Mounted Screen with 90 Degree Returns and Opening

Model	Dimensions	Price
EHP SCT10/90R5C/O	- 1000w x 500d x 750h (400w x 60h Opening)	£418
EHP SCT8/90R5C/O	- 800w x 500d x 750h (400w x 60h Opening)	£393
EHP SCT6/90R5C/O	- 600w x 500d x 750h (300w x 60h Opening)	£367

Screens Counter Top Mounted Acrylic Hygiene Protection Screens with 120 Degree Returns

Lead Time: Standard (All products are manufactured to order and when 'Standard Lead Time' is quoted (7 – 10 days), this may vary dependant on volume ordered, factory capacity and distribution requirements at the time of ordering. For more information please contact your Dealer Business Manager or the Customer Services Team for clarification.)

Acrylic: Clear

Metalwork: Fixing Brackets and Freestanding Feet supplied in Silver RAL 9006 (Standard) - Optional Black Graphite RAL 9004 and White RAL 9003



Acrylic Illustrated in Blue



EHPST10/120R5F
Acrylic Illustrated in Blue

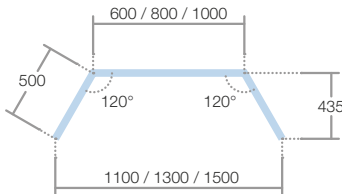

Elite Desk Mounted Acrylic Hygiene Protection Screen for Counter Tops with 120 Degree Returns

- Rectangular acrylic dividing screens supplied with freestanding feet or fixed brackets with 500w straight returns at 120 degrees.
- The freestanding version is freestanding on the desktop.
- The bracketed version is fixed to 25mm desktops only.
- Freestanding feet and brackets supplied in Silver RAL 9006 as standard.

Freestanding Desk Mounted Screen with 120 Degree Returns

	Price
EHPST10/120R5F - 1000w (front edge) 1500w (extreme) x 435d x 750h	£418
EHPST8/120R5F - 800w (front edge) 1300w (extreme) x 435d x 750h	£393
EHPST6/120R5F - 600w (front edge) 1100w (extreme) x 435d x 750h	£367

Bracketed Desk Mounted Screen with 120 Degree Returns

EHPST10/120R5C - 1000w (front edge) 1500w (extreme) x 435d x 750h	£418
EHPST8/120R5C - 800w (front edge) 1300w (extreme) x 435d x 750h	£393
EHPST6/120R5C - 600w (front edge) 1100w (extreme) x 435d x 750h	£367



EHPST10/120R5F/O
Acrylic Illustrated in Blue

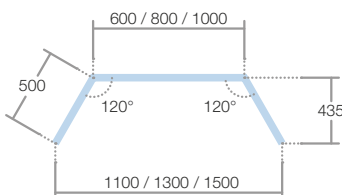

Elite Desk Mounted Acrylic Hygiene Protection Screen for Counter Tops with 120 Degree Returns and Opening

- Rectangular acrylic dividing screens supplied with freestanding feet or fixed brackets with 500w straight returns at 120 degrees.
- 300 / 400w x 60h opening is at the base of the front edge.
- The freestanding version is freestanding on the desktop.
- The bracketed version is fixed to 25mm desktops only.
- Freestanding feet and brackets supplied in Silver RAL 9006 as standard.

Freestanding Desk Mounted Screen with 120 Degree Returns and Opening

	Price
EHPST10/120R5F/O - 1000w (front edge) 1500w (extreme) x 435d x 750h (400w x 60h Opening)	£418
EHPST8/120R5F/O - 800w (front edge) 1300w (extreme) x 435d x 750h (400w x 60h Opening)	£393
EHPST6/120R5F/O - 600w (front edge) 1100w (extreme) x 435d x 750h (300w x 60h Opening)	£367

Bracketed Desk Mounted Screen with 120 Degree Returns and Opening

EHPST10/120R5C/O - 1000w (front edge) 1500w (extreme) x 435d x 750h (400w x 60h Opening)	£418
EHPST8/120R5C/O - 800w (front edge) 1300w (extreme) x 435d x 750h (400w x 60h Opening)	£393
EHPST6/120R5C/O - 600w (front edge) 1100w (extreme) x 435d x 750h (300w x 60h Opening)	£367

Floor Standing Screens



Floor standing screens are an excellent way to break up working environments, maximising the functionality of the space and surroundings. A range of floor standing screens are available to segregate open areas into flexible work environments that can be reconfigured easily, as the requirement of the space changes. The acoustic properties of the panels support the reduction of noise pollution and transfer to other areas.

Screens Floor Standing System Screens

Lead Time: Standard (All products are manufactured to order and when 'Standard Lead Time' is quoted (7 – 10 days), this may vary dependant on volume ordered, factory capacity and distribution requirements at the time of ordering. For more information please contact your Dealer Business Manager or the Customer Services Team for clarification.)

Metalwork: Available in Anodised Silver (Standard), Black Graphite RAL 9004 and White RAL 9003

Fabric: Fully upholstered with pinnable surface available in Groups 1-7

MFC: Available in Ash, Autumn Cherry, Beech, Chester Oak, English Walnut, Grey, Grey Nebraska Oak, Laurentii Wenge, Natural Nebraska Oak and White

Elite Floor Standing System Screen

- Straight floor standing screens with aluminium trim and optional management rail.
- Screen is fixed to the link post at either end or support foot can be used for stability.
- Optional 4 and 3 way link posts available (see page 294).
- Optional support foot available (see page 294).
- Available as Hygiene Protection Screens (see page 295-296).

- For Fabric, suffix ...F
- For MFC without Management Rail, suffix ...MFC
- For MFC with Management Rail, suffix .../MFC



Straight System Screen

	Group 1	Group 2	Group 3	Group 4	Group 5	Group 6	Group 7	MFC
EFSS16/17... - 1573w x 27d x 1700h	£761	£773	£785	£797	£809	£821	£833	£683
EFSS14/17... - 1373w x 27d x 1700h	£697	£709	£721	£733	£745	£757	£769	£629
EFSS12/17... - 1173w x 27d x 1700h	£643	£655	£667	£679	£691	£703	£715	£579
EFSS10/17... - 973w x 27d x 1700h	£578	£590	£602	£614	£626	£638	£650	£520
EFSS8/17... - 773w x 27d x 1700h	£541	£553	£565	£577	£589	£601	£613	£488
EFSS18/15... - 1773w x 27d x 1500h	£769	£781	£793	£805	£817	£829	£841	£691
EFSS16/15... - 1573w x 27d x 1500h	£708	£720	£732	£744	£756	£768	£780	£638
EFSS14/15... - 1373w x 27d x 1500h	£666	£678	£690	£702	£714	£726	£738	£599
EFSS12/15... - 1173w x 27d x 1500h	£606	£618	£630	£642	£654	£666	£678	£546
EFSS10/15... - 973w x 27d x 1500h	£559	£571	£583	£595	£607	£619	£631	£502
EFSS8/15... - 773w x 27d x 1500h	£512	£524	£536	£548	£560	£572	£584	£460
EFSS18/13... - 1773w x 27d x 1300h	£705	£717	£729	£741	£753	£765	£777	£635
EFSS16/13... - 1573w x 27d x 1300h	£657	£669	£681	£693	£705	£717	£729	£591
EFSS14/13... - 1373w x 27d x 1300h	£618	£630	£642	£654	£666	£678	£690	£558
EFSS12/13... - 1173w x 27d x 1300h	£567	£579	£591	£603	£615	£627	£639	£510
EFSS10/13... - 973w x 27d x 1300h	£517	£529	£541	£553	£565	£577	£589	£466
EFSS8/13... - 773w x 27d x 1300h	£485	£497	£509	£521	£533	£545	£557	£439
EFSS18/11... - 1773w x 27d x 1115h	£630	£642	£654	£666	£678	£690	£702	£567
EFSS16/11... - 1573w x 27d x 1115h	£599	£611	£623	£635	£647	£659	£671	£538
EFSS14/11... - 1373w x 27d x 1115h	£577	£589	£601	£613	£625	£637	£649	£519
EFSS12/11... - 1173w x 27d x 1115h	£529	£541	£553	£565	£577	£589	£601	£476
EFSS10/11... - 973w x 27d x 1115h	£485	£497	£509	£521	£533	£545	£557	£439
EFSS8/11... - 773w x 27d x 1115h	£454	£466	£478	£490	£502	£514	£526	£409

Straight System Screen with Management Rail

EFSS18/13M... - 1773w x 27d x 1300h	£803	£815	£827	£839	£851	£863	£875	£724
EFSS16/13M... - 1573w x 27d x 1300h	£778	£790	£802	£814	£826	£838	£850	£701
EFSS14/13M... - 1373w x 27d x 1300h	£739	£751	£763	£775	£787	£799	£811	£667
EFSS12/13M... - 1173w x 27d x 1300h	£669	£681	£693	£705	£717	£729	£741	£602
EFSS10/13M... - 973w x 27d x 1300h	£614	£626	£638	£650	£662	£674	£686	£550
EFSS8/13M... - 773w x 27d x 1300h	£549	£561	£573	£585	£597	£609	£621	£497
EFSS18/11M... - 1773w x 27d x 1115h	£778	£790	£802	£814	£826	£838	£850	£701
EFSS16/11M... - 1573w x 27d x 1115h	£732	£744	£756	£768	£780	£792	£804	£657
EFSS14/11M... - 1373w x 27d x 1115h	£690	£702	£714	£726	£738	£750	£762	£620
EFSS12/11M... - 1173w x 27d x 1115h	£637	£649	£661	£673	£685	£697	£709	£573
EFSS10/11M... - 973w x 27d x 1115h	£579	£591	£603	£615	£627	£639	£651	£523
EFSS8/11M... - 773w x 27d x 1115h	£499	£511	£523	£535	£547	£559	£571	£447

Screens Floor Standing System Screens

Lead Time: Standard (All products are manufactured to order and when 'Standard Lead Time' is quoted (7 – 10 days), this may vary dependant on volume ordered, factory capacity and distribution requirements at the time of ordering. For more information please contact your Dealer Business Manager or the Customer Services Team for clarification.)

Metalwork: Available in Anodised Silver (Standard), Black Graphite RAL 9004 and White RAL 9003

Fabric: Fully upholstered with pinnable surface available in Groups 1-7

MFC: Available in Ash, Autumn Cherry, Beech, Chester Oak, English Walnut, Grey, Grey Nebraska Oak, Laurentii Wenge, Natural Nebraska Oak and White

Elite Floor Standing System Screen

- Curved and wave floor standing screens with aluminium trim.
- Screen is fixed to the link post at either end or support foot can be used for stability.
- Optional 4 and 3 way link posts available (see page 294).
- Optional support foot available (see page 294).

- For Curved Fabric, suffix ...F/C
- For Curved MFC, suffix ...MFC/C

- For Wave Fabric, suffix ...F/W
- For Wave MFC, suffix ...MFC/W



Curved System Screen

Wave System Screen

Curved and Wave System Screen

	Group 1	Group 2	Group 3	Group 4	Group 5	Group 6	Group 7	MFC
EFSS16/17... - 1573w x 27d x 1700h	£738	£750	£762	£774	£786	£798	£810	£664
EFSS14/17... - 1373w x 27d x 1700h	£679	£691	£703	£715	£727	£739	£751	£613
EFSS12/17... - 1173w x 27d x 1700h	£621	£633	£645	£657	£669	£681	£693	£561
EFSS10/17... - 973w x 27d x 1700h	£567	£579	£591	£603	£615	£627	£639	£510
EFSS18/15... - 1773w x 27d x 1500h	£765	£777	£789	£801	£813	£825	£837	£689
EFSS16/15... - 1573w x 27d x 1500h	£701	£713	£725	£737	£749	£761	£773	£631
EFSS14/15... - 1373w x 27d x 1500h	£653	£665	£677	£689	£701	£713	£725	£587
EFSS12/15... - 1173w x 27d x 1500h	£598	£610	£622	£634	£646	£658	£670	£537
EFSS10/15... - 973w x 27d x 1500h	£538	£550	£562	£574	£586	£598	£610	£484
EFSS18/13... - 1773w x 27d x 1300h	£711	£723	£735	£747	£759	£771	£783	£642
EFSS16/13... - 1573w x 27d x 1300h	£661	£673	£685	£697	£709	£721	£733	£596
EFSS14/13... - 1373w x 27d x 1300h	£618	£630	£642	£654	£666	£678	£690	£558
EFSS12/13... - 1173w x 27d x 1300h	£567	£579	£591	£603	£615	£627	£639	£510
EFSS10/13... - 973w x 27d x 1300h	£519	£531	£543	£555	£567	£579	£591	£467
EFSS18/11... - 1773w x 27d x 1115h	£679	£691	£703	£715	£727	£739	£751	£613
EFSS16/11... - 1573w x 27d x 1115h	£621	£633	£645	£657	£669	£681	£693	£561
EFSS14/11... - 1373w x 27d x 1115h	£580	£592	£604	£616	£628	£640	£652	£524
EFSS12/11... - 1173w x 27d x 1115h	£519	£531	£543	£555	£567	£579	£591	£467
EFSS10/11... - 973w x 27d x 1115h	£480	£492	£504	£516	£528	£540	£552	£435

Screens Floor Standing System Screens with Acrylic Top Section

Lead Time: Standard (All products are manufactured to order and when 'Standard Lead Time' is quoted (7 – 10 days), this may vary dependant on volume ordered, factory capacity and distribution requirements at the time of ordering. For more information please contact your Dealer Business Manager or the Customer Services Team for clarification.)

Metalwork: Available in Anodised Silver (Standard), Black Graphite RAL 9004 and White RAL 9003

Fabric: Fully upholstered with pinnable surface available in Groups 1-7

MFC: Available in Ash, Autumn Cherry, Beech, Chester Oak, English Walnut, Grey, Grey Nebraska Oak, Laurentii Wenge, Natural Nebraska Oak and White

Acrylic: Available in Blue, Green, Orange, Red, Frosted and Clear

Elite Floor Standing System Screen with Acrylic Top Section

- Straight floor standing screens with aluminium trim and acrylic top section.
- Screen is fixed to the link post at either end or support foot can be used for stability.
- Optional 4 and 3 way link posts available (see page 294).
- Optional support foot available (see page 294).

- For Fabric, suffix ...F/A
- For MFC, suffix ...MFC/A



Half Glazed System Screen

Straight System Screen	Group 1	Group 2	Group 3	Group 4	Group 5	Group 6	Group 7	MFC
EFSS18/17... - 1773w x 27d x 1700h	£1,172	£1,184	£1,196	£1,208	£1,220	£1,232	£1,244	£1,054
EFSS16/17... - 1573w x 27d x 1700h	£1,087	£1,099	£1,111	£1,123	£1,135	£1,147	£1,159	£978
EFSS14/17... - 1373w x 27d x 1700h	£966	£978	£990	£1,002	£1,014	£1,026	£1,038	£867
EFSS12/17... - 1173w x 27d x 1700h	£872	£884	£896	£908	£920	£932	£944	£787
EFSS10/17... - 973w x 27d x 1700h	£770	£782	£794	£806	£818	£830	£842	£692
EFSS8/17... - 773w x 27d x 1700h	£701	£713	£725	£737	£749	£761	£773	£631
EFSS18/15... - 1773w x 27d x 1500h	£1,119	£1,131	£1,143	£1,155	£1,167	£1,179	£1,191	£1,009
EFSS16/15... - 1573w x 27d x 1500h	£1,036	£1,048	£1,060	£1,072	£1,084	£1,096	£1,108	£932
EFSS14/15... - 1373w x 27d x 1500h	£931	£943	£955	£967	£979	£991	£1,003	£837
EFSS12/15... - 1173w x 27d x 1500h	£843	£855	£867	£879	£891	£903	£915	£759
EFSS10/15... - 973w x 27d x 1500h	£753	£765	£777	£789	£801	£813	£825	£679
EFSS8/15... - 773w x 27d x 1500h	£663	£675	£687	£699	£711	£723	£735	£597
EFSS18/13... - 1773w x 27d x 1300h	£1,015	£1,027	£1,039	£1,051	£1,063	£1,075	£1,087	£915
EFSS16/13... - 1573w x 27d x 1300h	£931	£943	£955	£967	£979	£991	£1,003	£837
EFSS14/13... - 1373w x 27d x 1300h	£841	£853	£865	£877	£889	£901	£913	£755
EFSS12/13... - 1173w x 27d x 1300h	£772	£784	£796	£808	£820	£832	£844	£695
EFSS10/13... - 973w x 27d x 1300h	£690	£702	£714	£726	£738	£750	£762	£620
EFSS8/13... - 773w x 27d x 1300h	£606	£618	£630	£642	£654	£666	£678	£546
EFSS18/11... - 1773w x 27d x 1115h	£919	£931	£943	£955	£967	£979	£991	£827
EFSS16/11... - 1573w x 27d x 1115h	£872	£884	£896	£908	£920	£932	£944	£787
EFSS14/11... - 1373w x 27d x 1115h	£788	£800	£812	£824	£836	£848	£860	£708
EFSS12/11... - 1173w x 27d x 1115h	£711	£723	£735	£747	£759	£771	£783	£642
EFSS10/11... - 973w x 27d x 1115h	£626	£638	£650	£662	£674	£686	£698	£565
EFSS8/11... - 773w x 27d x 1115h	£541	£553	£565	£577	£589	£601	£613	£488

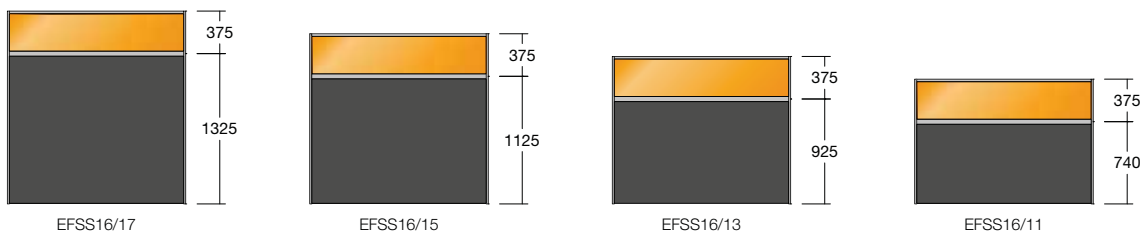

The above illustrations show the fabric / MFC and acrylic portions of the Elite half glazed floor standing system screen as standard.
For alternative sizes, contact sales.

Screens Floor Standing System Screen Accessories

Lead Time: Standard (All products are manufactured to order and when 'Standard Lead Time' is quoted (7 – 10 days), this may vary dependant on volume ordered, factory capacity and distribution requirements at the time of ordering. For more information please contact your Dealer Business Manager or the Customer Services Team for clarification.)

Metalwork: Available in Anodised Silver (Standard), Black Graphite RAL 9004 and White RAL 9003



EFLP17
Illustrated in red

Elite Floor Standing System Screen Linking Posts

- For Elite floor standing system screens only.

4 Way Linking Post

EFLP17	- For 1700h Screens	- 27w x 27d x 1700h	_____	
EFLP15	- For 1500h Screens	- 27w x 27d x 1500h	_____	
EFLP13	- For 1300h Screens	- 27w x 27d x 1300h	_____	
EFLP11	- For 1115h Screens	- 27w x 27d x 1115h	_____	
EFLP9	- For 915h Screens	- 27w x 27d x 915h	_____	

Metalwork

£136
£129
£119
£113
£98

3 Way Linking Post

EFLP17/120	- For 1700h Screens	- 27w x 27d x 1700h	_____	
EFLP15/120	- For 1500h Screens	- 27w x 27d x 1500h	_____	
EFLP13/120	- For 1300h Screens	- 27w x 27d x 1300h	_____	
EFLP11/120	- For 1115h Screens	- 27w x 27d x 1115h	_____	
EFLP9/120	- For 915h Screens	- 27w x 27d x 915h	_____	

£136
£129
£119
£113
£98



ESF1
Illustrated in red

Elite Floor Standing Screen Support Foot

- For Elite floor standing system screens only.

ESF1 - Sold Individually _____

Metalwork

£72



ELB
Illustrated in red

Elite Floor Standing Screen Support Bracket

- For Elite floor standing system screens only.

ELB - Sold in Pairs _____

Metalwork

£68

Screens Floor Standing Acrylic Hygiene Protection Screens

Lead Time: Standard (All products are manufactured to order and when 'Standard Lead Time' is quoted (7 – 10 days), this may vary dependant on volume ordered, factory capacity and distribution requirements at the time of ordering. For more information please contact your Dealer Business Manager or the Customer Services Team for clarification.)

Acrylic: Clear

MFC: Available in Ash, Autumn Cherry, Beech, Chester Oak, English Walnut, Grey, Grey Nebraska Oak, Laurentii Wenge, Natural Nebraska Oak and White
Also Available in Black (please contact Customer Services for specification, prices and lead time)

Metalwork: Freestanding Feet supplied in Silver RAL 9006 (Standard) - Optional Black Graphite RAL 9004 and White RAL 9003
Frame supplied in Anodised Silver .../SF (Standard) - Optional Black Graphite RAL 9004 .../BGF (add £54) and White RAL 9003 .../WF (add £54)



Acrylic Illustrated in Blue



EFHPS20/12MFC
Acrylic Illustrated in Blue



Elite Floor Standing Acrylic / MFC Hygiene Protection Screen

- Rectangular floor standing screens with aluminium trim, acrylic top section and 600h MFC bottom section.
- Freestanding feet supplied in Silver RAL 9006 as standard.

Floor Standing Screen

	Price
EFHPS22/14MFC... - 1400w x 27d x 2200h	£852
EFHPS20/14MFC... - 1400w x 27d x 2000h	£781
EFHPS18/14MFC... - 1400w x 27d x 1800h	£708
EFHPS22/12MFC... - 1200w x 27d x 2200h	£746
EFHPS20/12MFC... - 1200w x 27d x 2000h	£685
EFHPS18/12MFC... - 1200w x 27d x 1800h	£622
EFHPS22/10MFC... - 1000w x 27d x 2200h	£631
EFHPS20/10MFC... - 1000w x 27d x 2000h	£579
EFHPS18/10MFC... - 1000w x 27d x 1800h	£528

- For Anodised Silver Frame, suffix .../SF
- For Black Graphite Frame, add £54 and suffix .../BGF
- For White Frame, add £54 and suffix .../WF

Screens Floor Standing Acrylic Hygiene Protection Screens

Lead Time: Standard (All products are manufactured to order and when 'Standard Lead Time' is quoted (7 – 10 days), this may vary dependant on volume ordered, factory capacity and distribution requirements at the time of ordering. For more information please contact your Dealer Business Manager or the Customer Services Team for clarification.)

Acrylic: Clear

MFC: Available in Ash, Autumn Cherry, Beech, Chester Oak, English Walnut, Grey, Grey Nebraska Oak, Laurentii Wenge, Natural Nebraska Oak and White
Also Available in Black (please contact Customer Services for specification, prices and lead time)

Metalwork: Freestanding Feet supplied in Silver RAL 9006 (Standard) - Optional Black Graphite RAL 9004 and White RAL 9003
Frame supplied in Anodised Silver .../SF (Standard) - Optional Black Graphite RAL 9004 .../BGF (add £54) and White RAL 9003 .../WF (add £54)



Acrylic Illustrated in Blue



EFHPS20/12MFC/C
Acrylic Illustrated in Blue



Elite Mobile Floor Standing Acrylic / MFC Hygiene Protection Screen

- Rectangular floor standing screens with aluminium trim, acrylic top section and 600h MFC bottom section.
- Freestanding feet with castors supplied in Silver RAL 9006 as standard.

Mobile Floor Standing Screen

	Price
EFHPS22/14MFC/C... - 1400w x 27d x 2295h	£976
EFHPS20/14MFC/C... - 1400w x 27d x 2095h	£906
EFHPS18/14MFC/C... - 1400w x 27d x 1895h	£832
EFHPS22/12MFC/C... - 1200w x 27d x 2295h	£870
EFHPS20/12MFC/C... - 1200w x 27d x 2095h	£809
EFHPS18/12MFC/C... - 1200w x 27d x 1895h	£746
EFHPS22/10MFC/C... - 1000w x 27d x 2295h	£755
EFHPS20/10MFC/C... - 1000w x 27d x 2095h	£703
EFHPS18/10MFC/C... - 1000w x 27d x 1895h	£652

- For Anodised Silver Frame, suffix .../SF
- For Black Graphite Frame, add £54 and suffix .../BGF
- For White Frame, add £54 and suffix .../WF

Screens Medical / Patient Mobile Floor Standing Privacy Screen

Lead Time: Standard (All products are manufactured to order and when 'Standard Lead Time' is quoted (7 – 10 days), this may vary dependant on volume ordered, factory capacity and distribution requirements at the time of ordering. For more information please contact your Dealer Business Manager or the Customer Services Team for clarification.)

MFC: Available in White Only

Metalwork: Available in White RAL 9003 Only



PTPS

Medical / Patient Mobile Floor Standing Privacy Screen

- Freestanding mobile privacy screen.
- Additional screens can be linked via a simple linking hinge.
- Supplied with two independent locking castors.
- Steel frame surround and leg supports.
- MDF screen providing an acoustic barrier.
- Screens can be nested when not in use to save space.
- 100% recyclable.
- Easily cleaned.

Price

MMFSPS10 - 1000w x 385d x 1900h

£458



Huddle Pods Collaboration System Screens



Huddle Pods deliver segregated meeting areas within open plan spaces, great for informal discussions that require interaction with other parties. They are ideal for providing privacy in an otherwise busy and active workspace. Huddle Pods are available in 90, 60 and 45 degrees pods and can be linked to create a myriad of modular configurations. They are easily installed and can be reconfigured to offer a fully flexible environment.

Huddle Pods can be fully upholstered or for further functionality, whiteboards can be specified to provide an interactive suite for everyday gatherings between colleagues. They actively encourage communication and promote efficient and flexible cultures within the business and education community.

Screens Huddle Pod Screen

90 Degree Huddle Pod

- 1x screen will complete a 90 degree section.
- 4x sections to complete a full circle.
- Will accommodate standing area.

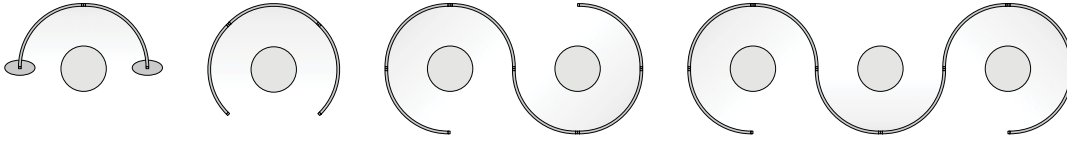

60 Degree Huddle Pod

- 1x screen will complete a 60 degree section.
- 6x sections to complete a full circle.
- Will accommodate standing area and / or sit down meetings.

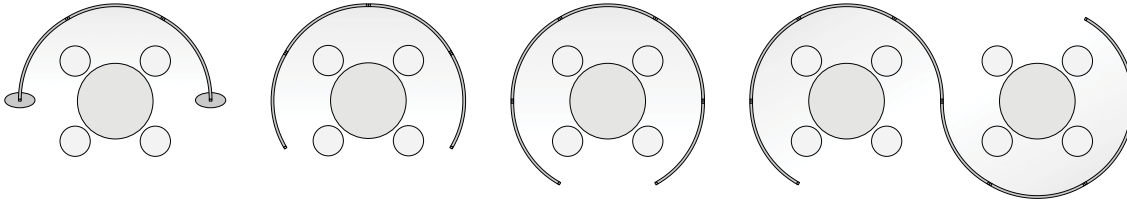

45 Degree Huddle Pod

- 1x screen will complete a 45 degree section.
- 8x sections to complete a full circle.
- Will accommodate standing area, sit down meetings and / or informal meetings.

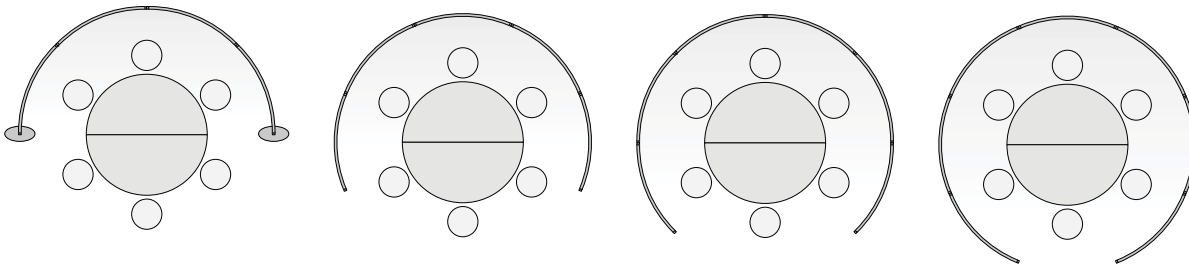

Huddle Pods

- The screen is constructed using aluminium extrusions.
- The fabric screen is constructed using MDF panels with face applied 2mm flame bonded foam backed fabric, retained within the aluminium frame.
- Acrylic screens constructed using two 3mm acrylic panels retained within the aluminium frame.
- Levelling feet allow for 25mm height adjustment.
- Huddle screens have been designed to comply with the following standards:
BS 1023-1:1997, BS 1023-2:2000 and BS 1023-3:2000.

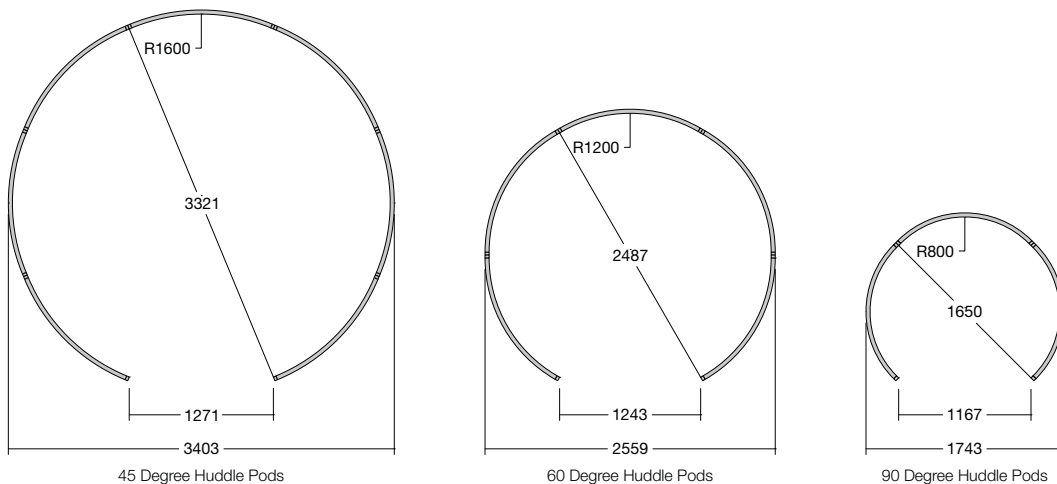

Lead Time: 4 Weeks

Metalwork: Available in Anodised Silver (Standard), Black Graphite RAL 9004 and White RAL 9003

Fabric: Fully upholstered with pinnable surface available in Groups A (Lucia and Cara) and B (Blazer Lite and Nexus)



HU60A12/18

Single Huddle Curved Screen with Bottom and Top Fabric Panels

- 4 week lead time.
- Fabric curved floor standing screens with aluminium trim (divides screen into 2x sections).
- Screens can be fixed to each other via its ends or support foot can be used for stability.
- Optional support foot available and required for screens making 180 degrees or less (see page 301).

		Group A	Group B
HU90A12/18	- 90 Degree Version - 1167w x 36d x 1785h	£1,400	£1,593
HU60A12/18	- 60 Degree Version - 1243w x 36d x 1785h	£1,400	£1,593
HU45A12/18	- 45 Degree Version - 1271w x 36d x 1785h	£1,400	£1,593



HU60B12/18

Single Huddle Curved Screen with Bottom Fabric Panels and Top Fabric on Inner and Whiteboard on Outer Curve Panels

- 4 week lead time.
- Fabric curved floor standing screens with aluminium trim (divides screen into 2x sections).
- Whiteboard on top section outer curve.
- Screens can be fixed to each other via its ends or support foot can be used for stability.
- Optional support foot available and required for screens making 180 degrees or less (see page 301).

		Group A	Group B
HU90B12/18	- 90 Degree Version - 1167w x 36d x 1785h	£1,524	£1,590
HU60B12/18	- 60 Degree Version - 1243w x 36d x 1785h	£1,524	£1,590
HU45B12/18	- 45 Degree Version - 1271w x 36d x 1785h	£1,524	£1,590



HU60C12/18

Single Huddle Curved Screen with Bottom Fabric Panels and Top Whiteboard on Inner and Fabric on Outer Curve Panels

- 4 week lead time.
- Fabric curved floor standing screens with aluminium trim (divides screen into 2x sections).
- Whiteboard on top section inner curve.
- Screens can be fixed to each other via its ends or support foot can be used for stability.
- Optional support foot available and required for screens making 180 degrees or less (see page 301).

		Group A	Group B
HU90C12/18	- 90 Degree Version - 1167w x 36d x 1785h	£1,524	£1,590
HU60C12/18	- 60 Degree Version - 1243w x 36d x 1785h	£1,524	£1,590
HU45C12/18	- 45 Degree Version - 1271w x 36d x 1785h	£1,524	£1,590



HU60D12/18

Single Huddle Curved Screen with Bottom Fabric and Top Whiteboard Panels

- 4 week lead time.
- Fabric curved floor standing screens with aluminium trim (divides screen into 2x sections).
- Whiteboard on top section.
- Screens can be fixed to each other via its ends or support foot can be used for stability.
- Optional support foot available and required for screens making 180 degrees or less (see page 301).

		Group A	Group B
HU90D12/18	- 90 Degree Version - 1167w x 36d x 1785h	£1,637	£1,703
HU60D12/18	- 60 Degree Version - 1243w x 36d x 1785h	£1,637	£1,703
HU45D12/18	- 45 Degree Version - 1271w x 36d x 1785h	£1,637	£1,703

Lead Time: 4 Weeks

Metalwork: Available in Anodised Silver (Standard), Black Graphite RAL 9004 and White RAL 9003

Fabric: Fully upholstered with pinnable surface available in Groups A (Lucia and Cara) and B (Blazer Lite and Nexus)

Acrylic: Available in Blue, Green, Orange, Red, Frosted and Clear



HU60E12/18

Single Huddle Curved Screen with Bottom, Middle and Top Fabric Panels

- Fabric curved floor standing screens with aluminium trim (divides screen into 3x sections).
- Screens can be fixed to each other via its ends or support foot can be used for stability.
- Optional support foot available and required for screens making 180 degrees or less (see below).

	Group A	Group B
HU90E12/18 - 90 Degree Version - 1167w x 36d x 1785h	£1,631	£1,827
HU60E12/18 - 60 Degree Version - 1243w x 36d x 1785h	£1,631	£1,827
HU45E12/18 - 45 Degree Version - 1271w x 36d x 1785h	£1,631	£1,827



HU60F12/18

Single Huddle Curved Screen with Bottom and Middle Fabric and Top Acrylic Panels

- Fabric curved floor standing screens with aluminium trim (divides screen into 3x sections).
- Acrylic on top section.
- Screens can be fixed to each other via its ends or support foot can be used for stability.
- Optional support foot available and required for screens making 180 degrees or less (see below).

	Group A	Group B
HU90F12/18 - 90 Degree Version - 1167w x 36d x 1785h	£1,930	£2,063
HU60F12/18 - 60 Degree Version - 1243w x 36d x 1785h	£1,930	£2,063
HU45F12/18 - 45 Degree Version - 1271w x 36d x 1785h	£1,930	£2,063



HU60G12/18

Single Huddle Curved Screen with Bottom and Top Fabric and Middle Acrylic Panels

- Fabric curved floor standing screens with aluminium trim (divides screen into 3x sections).
- Acrylic on middle section.
- Screens can be fixed to each other via its ends or support foot can be used for stability.
- Optional support foot available and required for screens making 180 degrees or less (see below).

	Group A	Group B
HU90G12/18 - 90 Degree Version - 1167w x 36d x 1785h	£1,930	£2,063
HU60G12/18 - 60 Degree Version - 1243w x 36d x 1785h	£1,930	£2,063
HU45G12/18 - 45 Degree Version - 1271w x 36d x 1785h	£1,930	£2,063



HU60H12/18

Single Huddle Curved Screen with Bottom Fabric and Middle and Top Acrylic Panels

- Fabric curved floor standing screens with aluminium trim (divides screen into 3x sections).
- Acrylic on top and middle section.
- Screens can be fixed to each other via its ends or support foot can be used for stability.
- Optional support foot available and required for screens making 180 degrees or less (see below).

	Group A	Group B
HU90H12/18 - 90 Degree Version - 1167w x 36d x 1785h	£2,176	£2,243
HU60H12/18 - 60 Degree Version - 1243w x 36d x 1785h	£2,176	£2,243
HU45H12/18 - 45 Degree Version - 1271w x 36d x 1785h	£2,176	£2,243



HUSSF
Illustrated in red

Huddle Single Screen Foot

- To be used on screens comprising of 180 degrees or less.

	Metalwork
HUSSF - Sold Individually - 500w x 200d	£90

Park and Hush Collaboration Screens



Park acoustic panels have been inspired by the shapes and colours of nature. All timber is fully certified to FSC standards emphasising the strict eco and sustainability philosophy that lead to the creation of Park screens mirroring the traditional tree shape. Clustering screens creates a partition wall to divide and define the workplace. The lightweight construction enables Park to be configured and re-configured easily creating lounge, meeting room and private spaces within the open plan environment.

Hush acoustic panels can be arranged in a variety of configurations dependent on your requirements. They can be mounted to walls and ceilings ensuring sufficient absorption within the chosen environment. The panels are simple to install, dismantle and reassemble for complete flexibility. Hush panels are high performance soundproofing specifically developed to offer complete flexibility. Each panel is upholstered in a two tone fabric enabling panels to be reversed refreshing the environment aesthetics. There are 5 colour combinations within the range.

Lead Time: 7 Weeks

Fabric: Fully upholstered with pinnable surface available in the 4 colours below



PAR/S

Park Single Small Acoustic Screen

- 7 week lead time.
- Small acoustic panel with Oak support frame.

Fabric

PAR/S - 990w x 290d x 1260h

£868



PAR/L

Park Single Large Acoustic Screen

- 7 week lead time.
- Large acoustic panel with Oak support frame.

Fabric

PAR/L - 990w x 290d x 1660h

£953



Ochre (Melange)



Yellow (Melange)



Green (Melange)



Dark Green (Melange)



Lead Time: 7 Weeks

Fabric: Fully upholstered with pinnable surface available in the 5 reversible colours below



HUS/WM

Hush Single Wall Mounted Acoustic Panel

- 7 week lead time.
- Reversible acoustic wall panels with timber centre.
- Fixing kit included for wall mounting.

HUS/WM - 590w x 590h

Fabric

£297



Yellow
Orange



Green
Dark Green



Dark Blue
Blue



Red
Cream

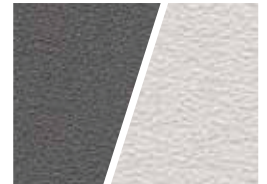

Grey
Cream



Testing Pod Pathogen / Covid Testing Pod

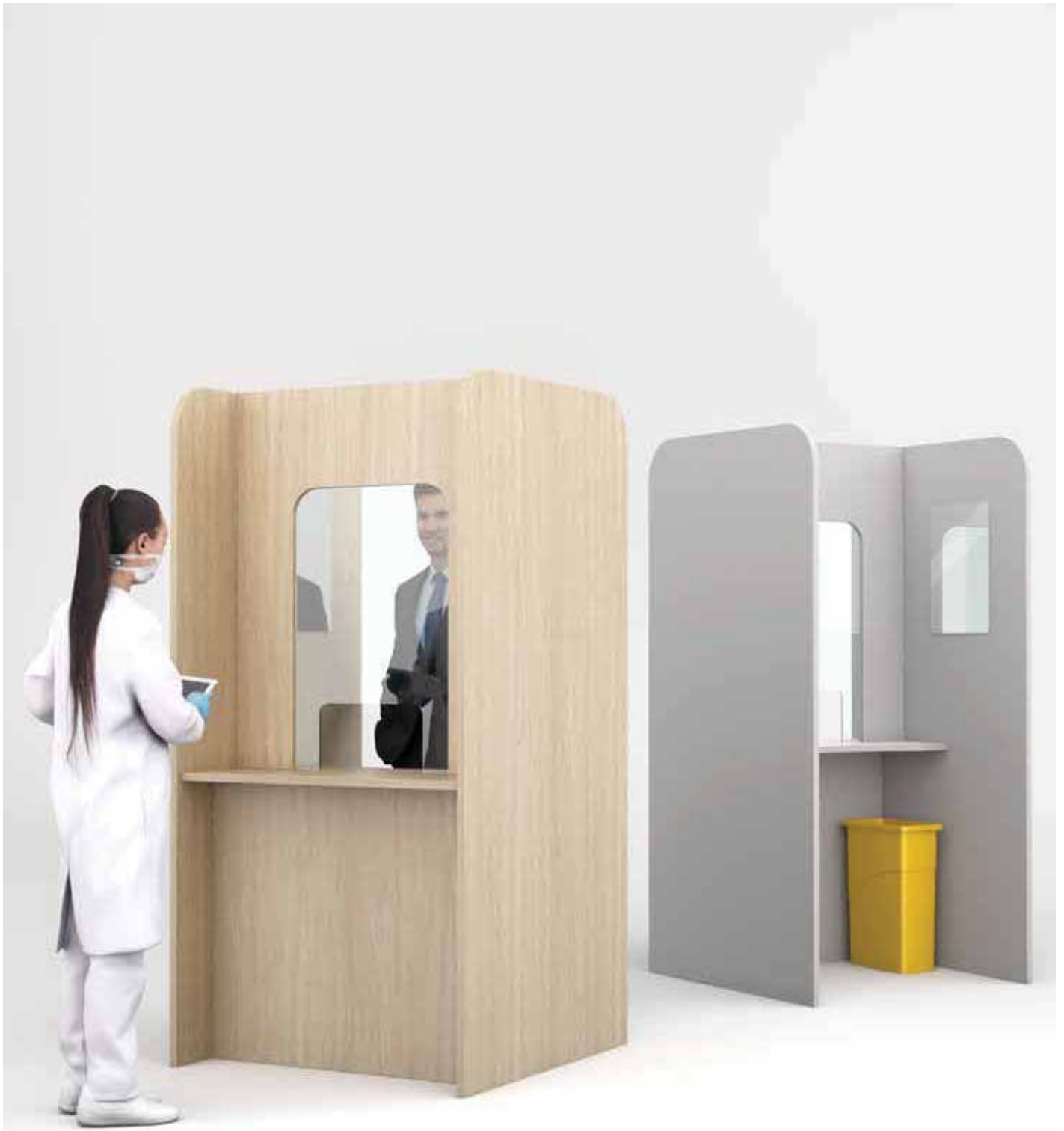

Our Pathogen/COVID testing pod is a singular unit, designed to offer a safe and comfortable area for carrying out vital RNA tests. We have designed our pod to be both sturdy, practical and aesthetically pleasing while providing solutions for staff, students and general public screening.

Lead Time: Standard (All products are manufactured to order and when 'Standard Lead Time' is quoted (7 – 10 days), this may vary dependant on volume ordered, factory capacity and distribution requirements at the time of ordering. For more information please contact your Dealer Business Manager or the Customer Services Team for clarification.)

Acrylic: Clear

MFC: Available in Ash, Autumn Cherry, Beech, Chester Oak, English Walnut, Grey, Grey Nebraska Oak, Laurentii Wenge, Natural Nebraska Oak and White



PTPS



PTPS

Pathogen / Covid Testing Pod

- Freestanding individual pod.
- Protective acrylic screen with lower cutout for operative staff protection.
- Acrylic screen cutout allows testing kits to be passed through.
- Worksurface ledges for operative staff use and participant.
- Mirror included for a participant to observe their RNA swab procedure.

MFC

PTPS - 1000w x 1000d x 2000h

£1,075



Accessories



Elite have a large portfolio of accessories to complement and enhance the effectiveness and flexibility of our furniture ranges. Accessories for monitor arms, desk mounted electrics, lighting and paper filing systems offer further solutions to improve efficiency. We recognise that the use of smart technology has evolved and our electrical range provides a multitude of solutions to bring power, data and charging facilities to the surface of our desking and table units.

Accessories Management Rail Screen Mounted Accessories

Lead Time: Standard (All products are manufactured to order and when 'Standard Lead Time' is quoted (7 – 10 days), this may vary dependant on volume ordered, factory capacity and distribution requirements at the time of ordering. For more information please contact your Dealer Business Manager or the Customer Services Team for clarification.)

Metalwork: DTFSA, DTFSB and DTFSC: Available in Silver Plastic Only
DTFSD, DTFSG, DTFSK, DTFSL and DTFSM: Available in Silver RAL 9006 (Standard) and White RAL 9003



DTFSA

3x A4 In-Pending-Out Trays

- Moulded plastic.
- Compatible with system screens with management rail.
- Silver plastic only.

Price

DTFSA - 270w x 345d x 260h | £139



DTFSB

Envelope Tray

- Moulded plastic.
- Compatible with system screens with management rail.
- Silver plastic only.

Price

DTFSB - 385w x 280d x 60h | £38



DTFSC

Stationary Compartments with Removable Items

- Moulded plastic.
- Compatible with system screens with management rail.
- Silver plastic only.

Price

DTFSC - 380w x 165d x 60h | £71



DTFSD

Name Plate

- Fabricated steel.
- Compatible with system screens with management rail.

Metalwork

DTFSD - 210w x 13d x 44h | £65



DTFSG

Magnetic Memo Board with 3x Magnets

- Fabricated steel.
- Compatible with system screens with management rail.

Metalwork

DTFSG - 290w x 8d x 210h | £61



DTFSK

Vertical A4 Paper Tray

- Fabricated steel.
- Compatible with system screens with management rail.

Metalwork

DTFSK - 330w x 94d x 237h | £70



DTFSL

Landscape A4 Paper Tray

- Fabricated steel.
- Compatible with system screens with management rail.

Metalwork

DTFSL - 340w x 250d x 62h | £65



DTFSM

3x Hanging Landscape A4 Paper Trays and Stacker

- Fabricated steel.
- Compatible with system screens with management rail.
- Not compatible with acrylic screens

Metalwork

DTFSM - 340w x 265d x 270h | £275

Accessories Power Modules

Lead Time: Standard (All products are manufactured to order and when 'Standard Lead Time' is quoted (7 – 10 days), this may vary dependant on volume ordered, factory capacity and distribution requirements at the time of ordering. For more information please contact your Dealer Business Manager or the Customer Services Team for clarification.)

Finish: Kaspa: Available with Silver Body with Black Inserts, Black Body with Black Inserts and Matt White Body with Black Inserts

Finish: Prime: Available with Silver Body with Black Inserts, Black Body with Black Inserts and Matt White Body with Black Inserts

Guarantee: 1 Year Guarantee on All Electrical Items



POW/KAS/1P1T/S

Kaspa Power and Media Module

- 1x or 2x 3.15 amp individually fused sockets.
- 1x USB twin charger (type A+A).
- Integral colour coded fuse clips.
- 200mm power and connection lead to 3 pole connector.
- Fixing via 135w x 53d (1 gang) or 189w x 53d (2 gang) aperture.
- Requires a separate mains lead if connecting directly into a socket (see page 319).

									Price
POW/KAS/1P1T/S	- 1x Power, 1x USB Twin Charger	- Silver	- 151w x 70d						£197
POW/KAS/1P1T/B	- 1x Power, 1x USB Twin Charger	- Black	- 151w x 70d						£197
POW/KAS/1P1T/W	- 1x Power, 1x USB Twin Charger	- White	- 151w x 70d						£197
POW/KAS/2P1T/S	- 2x Power, 1x USB Twin Charger	- Silver	- 204w x 70d						£220
POW/KAS/2P1T/B	- 2x Power, 1x USB Twin Charger	- Black	- 204w x 70d						£220
POW/KAS/2P1T/W	- 2x Power, 1x USB Twin Charger	- White	- 204w x 70d						£220



POW/KAS/1P1T/S
Silver Body with Black Inserts



POW/KAS/1P1T/B
Black Body with Black Inserts



POW/KAS/1P1T/W
Matt White Body with Black Inserts



POW/PRI/2P1T/S
Showing 3x Power Version

Prime Power and Media Module

- 2x 3.15 amp individually fused sockets.
- 1x USB twin charger (type A+A).
- 200mm power and connection lead to 3 pole connector.
- Fixing via 225w x 60d aperture.
- Requires a separate mains lead if connecting directly into a socket (see page 319).

									Price
POW/PRI/2P1T/S	- 2x Power, 1x USB Twin Charger	- Without Cover	- Silver	- 241w x 73d	-				£235
POW/PRI/2P1T/B	- 2x Power, 1x USB Twin Charger	- Without Cover	- Black	- 241w x 73d	-				£235
POW/PRI/2P1T/W	- 2x Power, 1x USB Twin Charger	- Without Cover	- White	- 241w x 73d	-				£235



POW/PRI/2P1T/S
Silver Body with Black Inserts



POW/PRI/2P1T/B
Black Body with Black Inserts



POW/PRI/2P1T/W
Matt White Body with Black Inserts



POW/PRI/2P1T/C/S

Prime Power and Media Module With Cover

- 2x 3.15 amp individually fused sockets.
- 1x USB twin charger (type A+A).
- 200mm power and connection lead to 3 pole connector.
- Fixing via 225w x 60d aperture.
- Casing provided to discretely protect cables and sockets.
- Requires a separate mains lead if connecting directly into a socket (see page 319).

									Price
POW/PRI/2P1T/C/S	- 2x Power, 1x USB Twin Charger	- With Cover	- Silver	- 257w x 88d	-				£333
POW/PRI/2P1T/C/B	- 2x Power, 1x USB Twin Charger	- With Cover	- Black	- 257w x 88d	-				£333
POW/PRI/2P1T/C/W	- 2x Power, 1x USB Twin Charger	- With Cover	- White	- 257w x 88d	-				£333



POW/PRI/2P1T/C/S
Silver Body with Black Inserts



POW/PRI/2P1T/C/B
Black Body with Black Inserts



POW/PRI/2P1T/C/W
Matt White Body with Black Inserts

Lead Time: Standard (All products are manufactured to order and when 'Standard Lead Time' is quoted (7 – 10 days), this may vary dependant on volume ordered, factory capacity and distribution requirements at the time of ordering. For more information please contact your Dealer Business Manager or the Customer Services Team for clarification.)

Finish: Conus: Available with Silver Body with Black Inserts, Black Body with Black Inserts and Matt White Body with Black Inserts (All with a 3 Week Lead Time)

Guarantee: 1 Year Guarantee on All Electrical Items



POW/CON/2P1D/S...

Conus Boardroom Power Module

- 2x or 4x 3.15 amp individually fused sockets.
- 1x or 2x various additional data options (HDMI (.../OP1), VGA / Jack (.../OP2), USB twin charger (.../OP3), 2x CAT6A (.../OP4) and Blank Front (.../OP5).
- Suffix 1x data option onto 2 Gang versions (e.g. POW/CON/2P1D/S/OP2) and 2x data options onto 4 Gang versions (e.g. POW/CON/4P2D/S/OP1/OP3).
- 200mm power and connection lead to 3 pole connector.
- Fixing via 230w x 138d (2 gang) or 369w x 138d (4 gang) aperture.
- Requires a separate mains lead if connecting directly into a socket (see page 319).

									Price
POW/CON/2P1D/S...	- 2x Power, 1x Data Option	- Silver	- 255w x 151d	_____					£295
POW/CON/2P1D/B...	- 2x Power, 1x Data Option	- Black	- 255w x 151d	_____					£295
POW/CON/2P1D/W...	- 2x Power, 1x Data Option	- White	- 255w x 151d	_____					£295
POW/CON/4P2D/S...	- 4x Power, 2x Data Option	- Silver	- 387w x 151d	_____					£366
POW/CON/4P2D/B...	- 4x Power, 2x Data Option	- Black	- 387w x 151d	_____					£366
POW/CON/4P2D/W...	- 4x Power, 2x Data Option	- White	- 387w x 151d	_____					£366



POW/CON/2P1D/S
Silver Body with Black Inserts



POW/CON/2P1D/B
Black Body with Black Inserts



POW/CON/2P1D/W
Matt White Body with Black Inserts



.../OP2



.../OP3



.../OP5

Conus Data Options

- Suffix 1x data option onto 2 Gang versions (e.g. POW/CON/2P1D/S/OP2) and 2x data options onto 4 Gang versions (e.g. POW/CON/4P2D/S/OP1/OP3).
- HDMI (.../OP1). • VGA / Jack (.../OP2). • USB Twin Charger (.../OP3).
- 2x CAT6A (.../OP4). • Blank Front (.../OP5).

									Price
.../OP1	- HDMI with 3m Tails	_____							£94
.../OP2	- VGA / Jack with 3m Tails	_____							£124
.../OP3	- USB Twin Charger (Type A+C)	_____							£96
.../OP4	- 2x CAT6A with 3m Tails	_____							£104
.../OP5	- Blank Front	_____							£4



Lead Time: 3 Weeks (Peak) or Standard (Escalate) (All products are manufactured to order and when 'Standard Lead Time' is quoted (7 - 10 days), this may vary dependant on volume ordered, factory capacity and distribution requirements at the time of ordering. For more information please contact your Dealer Business Manager or the Customer Services Team for clarification.)

Finish: Peak: Available with Stainless Steel Silver Body with Black Inserts, Black Body with Black Inserts and Matt White Body with Grey Inserts (All with a 3 Week Lead Time)

Finish: Escalate: Available with Silver Body

Guarantee: 1 Year Guarantee on All Electrical Items



PEAPM60/S



PEAPM80/W



PEAPM60/S

Stainless Steel Silver Body with Black Inserts



PEAPM80/B

Black Body with Black Inserts



PEAPM80/W

Matt White Body with Grey Inserts

Peak Power and Media Module

- 3 week lead time.
- 4x or 6x 3.15 amp individually fused sockets.
- 2x USB twin chargers (type A+C).
- Integral colour coded fuse clips.
- Hardwired 800mm lead to GST18/3 male/b.
- Includes 4x screw clamps.
- Fixing via 192w x 132d (4 gang) or 272w x 132d (6 gang) aperture.
- Requires a separate mains lead if connecting directly into a socket (see page 319).

PEAPM60/S	- 4x Power, 2x USB Twin Charger	- Silver	- 220w x 155d	_____	£797
PEAPM60/B	- 4x Power, 2x USB Twin Charger	- Black	- 220w x 155d	_____	£826
PEAPM60/W	- 4x Power, 2x USB Twin Charger	- White	- 220w x 155d	_____	£826

PEAPM80/S	- 6x Power, 2x USB Twin Charger	- Silver	- 300w x 155d	_____	£851
PEAPM80/B	- 6x Power, 2x USB Twin Charger	- Black	- 300w x 155d	_____	£885
PEAPM80/W	- 6x Power, 2x USB Twin Charger	- White	- 300w x 155d	_____	£885

Price



POW/ESC/1P1T/S



POW/ESC/1P1T/S

Escalate Power and Media Module

- 1x 3.15 amp individually fused socket.
- 1x USB twin charger (type A+A).
- 500mm power and connection lead to 3 pole connector.
- Fixing via 80w porthole aperture.
- Requires a separate mains lead if connecting directly into a socket (see page 319).

POW/ESC/1P1T/S	- 1x Power, 1x USB Twin Charger	- Silver	- 95w (dia) x 230h	_____	£202
-----------------------	---------------------------------	----------	--------------------	-------	------

Price

Accessories Power Modules

Lead Time: Standard (All products are manufactured to order and when 'Standard Lead Time' is quoted (7 – 10 days), this may vary dependant on volume ordered, factory capacity and distribution requirements at the time of ordering. For more information please contact your Dealer Business Manager or the Customer Services Team for clarification.)

Finish: **Wireless Charging Unit:** Available with Black Body and Trim, Black Body and Aluminium Trim, White Body and Trim and White Body and Aluminium Trim

Guarantee: 1 Year Guarantee on All Electrical Items



WCU/BB

Wireless Charging Unit

- Charge smartphones and tablets wirelessly. • Fixing via 80w porthole aperture.
- Charging unit complete with USB power plug.
- Wireless Charging Receiver required when device does not support wireless charging.

					Price
WCU/BB	- Charging Unit	- Black	- 85w (dia)	_____	£194
WCU/WW	- Charging Unit	- White	- 85w (dia)	_____	£194
WCU/AB	- Charging Unit	- Aluminium / Black	- 85w (dia)	_____	£236
WCU/AW	- Charging Unit	- Aluminium / White	- 85w (dia)	_____	£236
WCU/BG	- Charging Unit	- Black Glass	- 85w (dia)	_____	£250
WCU/WG	- Charging Unit	- White Glass	- 85w (dia)	_____	£250



WCU/BB
Black Body and Trim



WCU/WW
White Body and Trim



WCU/AB
Black Body and Aluminium Trim



WCU/AW
White Body and Aluminium Trim



WCU/BG
Black Glass Body and Trim



WCU/WG
White Glass Body and Trim



WCU/DP/BGB

Dual Pro Wireless Charging Unit

- Lid cover slides to reveal 3x USB chargers (type A+A+C). • Charge smartphones and tablets wirelessly.
- 65W laptop charging without a traditional brick power cord. • Fixing via 80w porthole aperture.
- Charging unit complete with USB power plug.
- Wireless Charging Receiver required when device does not support wireless charging.

					Price
WCU/DP/BGS	- Dual Pro Charging Unit	- Black Glass with Silver Base	- 203w x 93d x 8h	_____	£283
WCU/DP/WGS	- Dual Pro Charging Unit	- White Glass with Silver Base	- 203w x 93d x 8h	_____	£283
WCU/DP/BGB	- Dual Pro Charging Unit	- Black Glass with Black Base	- 203w x 93d x 8h	_____	£283
WCU/DP/WGB	- Dual Pro Charging Unit	- White Glass with Black Base	- 203w x 93d x 8h	_____	£283



WCU/DP/BGS
Black Glass with Silver Base



WCU/DP/WGS
White Glass with Silver Base



WCU/DP/BGB
Black Glass with Black Base



WCU/DP/WGB
White Glass with Black Base



WCU/WCR

Wireless Charging Receiver

- Charge smartphones and tablets wirelessly.
- Wireless Charging Unit required to support wireless charging.

				Price
WCU/WCR	- Wireless Charging Receiver	_____	_____	£119

Accessories Power Modules

Lead Time: Standard (All products are manufactured to order and when 'Standard Lead Time' is quoted (7 – 10 days), this may vary dependant on volume ordered, factory capacity and distribution requirements at the time of ordering. For more information please contact your Dealer Business Manager or the Customer Services Team for clarification.)

Finish: Port Hole: Available with Grey Body, Black Body or White Body

Finish: Pix: Available with Black Body with Silver Trim or White Body with White Trim

Guarantee: 1 Year Guarantee on All Electrical Items - Flex Modules Conform to BS5733 and BS6396:2008 Guidelines



PHPM/G

Port Hole Power and Media Module

- 1x 3.15 amp individually fused socket.
- 1x USB twin charger (type A+A).
- 1m connection lead.
- Fixing via 80w porthole aperture.
- Requires a separate mains lead if connecting directly into a socket (see page 319).
- USB twin charger (type A+A) will be changing to type A+C during 2021-2022.

Price

PHPM/G	- 1x Power, 1x USB Twin Charger	- Grey	- 95w (dia)	_____	£192
PHPM/B	- 1x Power, 1x USB Twin Charger	- Black	- 95w (dia)	_____	£192
PHPM/W	- 1x Power, 1x USB Twin Charger	- White	- 95w (dia)	_____	£192



PHPM/G
Grey



PHPM/B
Black



PHPM/W
White



POW/PIX/1P1T/B

Pix Power and Media Module

- 1x 3.15 amp individually fused socket.
- 1x USB twin charger (type A+C).
- 800mm connection lead.
- Fixing via 80w porthole aperture.
- Requires a separate mains lead if connecting directly into a socket (see page 319).

Price

POW/PIX/1P1T/B	- 1x Power, 1x USB Twin Charger	- Black	- 90w (dia) x 16h	_____	£237
POW/PIX/1P1T/W	- 1x Power, 1x USB Twin Charger	- White	- 90w (dia) x 16h	_____	£237



POW/PIX/1P1T/B
Black



POW/PIX/1P1T/W
White



Accessories Power Modules

Lead Time: Standard (All products are manufactured to order and when 'Standard Lead Time' is quoted (7 – 10 days), this may vary dependant on volume ordered, factory capacity and distribution requirements at the time of ordering. For more information please contact your Dealer Business Manager or the Customer Services Team for clarification.)

Finish: Pluto: Available with Grey Body with Black Inserts, Black Body with Grey Inserts and White Body with Grey Inserts

Finish: Inca: Available with Grey Body, Black Body or White Body

Guarantee: 1 Year Guarantee on All Electrical Items



PLU/3P/G

Pluto Power Module

- 3x 3.15 amp individually fused sockets. • Fixing via 80w porthole aperture.
- Requires a separate mains lead if connecting directly into a socket (see page 195).

		Price
PLU/3P/G	- 3x Power - Grey Body / Black Inserts - 140w (dia) x 73h	£230
PLU/3P/B	- 3x Power - Black Body / Grey Inserts - 140w (dia) x 73h	£230
PLU/3P/W	- 3x Power - White Body / Grey Inserts - 140w (dia) x 73h	£230



PLU/2P/1USB/G

Pluto Power and Media Module

- 2x 3.15 amp individually fused sockets. • 1x USB twin charger (type A+C).
- Fixing via 80w porthole aperture.
- Requires a separate mains lead if connecting directly into a socket (see page 195).

		Price
PLU/2P/1USB/G	- 2x Power, 1x USB Twin Charger - Grey Body / Black Inserts - 140w (dia) x 73h	£374
PLU/2P/1USB/B	- 2x Power, 1x USB Twin Charger - Black Body / Grey Inserts - 140w (dia) x 73h	£374
PLU/2P/1USB/W	- 2x Power, 1x USB Twin Charger - White Body / Grey Inserts - 140w (dia) x 73h	£374



PLU2P/1USB/G
Grey Body with Black Inserts



PLU2P/1USB/B
Black Body with Grey Inserts



PLU2P/1USB/W
White Body with Grey Inserts



IPM/G

Inca Power and Media Module

- 2x 3.15 amp individually fused sockets. • 2x USB twin chargers (type A+A).
- Hardwired 1000mm mains lead to male Wieland. • Fixing via 80w porthole aperture.
- Requires a separate mains lead if connecting directly into a socket (see page 319).
- USB twin charger (type A+A) will be changing to type A+C during 2021-2022.

		Price
IPM/G	- 2x Power, 2x USB Twin Charger - Grey - 140w x 140d x 72h	£417
IPM/B	- 2x Power, 2x USB Twin Charger - Black - 140w x 140d x 72h	£417
IPM/W	- 2x Power, 2x USB Twin Charger - White - 140w x 140d x 72h	£417



IPM/G
Grey



IPM/B
Black



IPM/W
White



Lead Time: 3 Weeks (Black and White) and Standard (Grey) (All products are manufactured to order and when 'Standard Lead Time' is quoted (7 - 10 days), this may vary dependant on volume ordered, factory capacity and distribution requirements at the time of ordering. For more information please contact your Dealer Business Manager or the Customer Services Team for clarification.)

Metalwork: Available in Silver RAL 9006 (Standard), Black Graphite RAL 9004, White RAL 9003, Chrome Effect (Add 15%) and Raw finish (Add 5%)

Finish: Available with Grey Aluminium Body and Grey Plastic Ends (Standard), Black Plastic Body and Ends (3 Week Lead Time) and White Plastic Body and Ends (3 Week Lead Time)

Guarantee: 1 Year Guarantee on All Electrical Items



FDT/2P/W

Flex Desktop Power Module

- 3 week lead time on black and white power modules.
- 2x 3.15 amp individually fused sockets. • Power and connection lead to 3 pole connector.
- Cables exit from unit back. • Optional desktop clamps available (see below).
- Requires a separate mains lead if connecting directly into a socket (see page 319).

	Price
FDT/2P/G - 2x Power - Grey	£74
FDT/2P/B - 2x Power - Black - 3 Week Lead Time	£67
FDT/2P/W - 2x Power - White - 3 Week Lead Time	£67



FDT/1P/2USB/G

Flex Desktop Power and Media Module

- 3 week lead time on black and white power modules.
- 1x or 2x 3.15 amp individually fused sockets. • 1x USB twin charger (type A+C).
- Power and connection lead to 3 pole connector. • Cables exit from unit back.
- Optional desktop clamps available (see below).
- Requires a separate mains lead if connecting directly into a socket (see page 319).

	Price
FDT/1P/2USB/G - 1x Power, 1x USB Twin Charger - Grey	£149
FDT/1P/2USB/B - 1x Power, 1x USB Twin Charger - Black - 3 Week Lead Time	£142
FDT/1P/2USB/W - 1x Power, 1x USB Twin Charger - White - 3 Week Lead Time	£142



FDT/2P/2USB/B

FDT/2P/2USB/G - 2x Power, 1x USB Twin Charger - Grey	£167
FDT/2P/2USB/B - 2x Power, 1x USB Twin Charger - Black - 3 Week Lead Time	£161
FDT/2P/2USB/W - 2x Power, 1x USB Twin Charger - White - 3 Week Lead Time	£161



FDT/1P/2USB/G
Grey Aluminium Body and Grey Plastic Ends



FDT/2P/2USB/B
Black Plastic Body and Ends
3 Week Lead Time



FDT/2P/W
White Plastic Body and Ends
3 Week Lead Time



FDPC2

Flex Desktop Power Module Fixing Clamp

- Compatible with Flex power modules. • Clamps modules to chosen desks.

	Metalwork
FDPC1 - Flex	£13
• For Single Desks: Progress Plus, Progress, Linnea Elevate, Linnea and Matrix single desks. Kassini, Optima Plus, Reflex, Callisto, Windsor, Flexi entire ranges.	

FDPC2 - Flex	£13
• For Double Bench Desks: Progress Plus, Progress, Progress Lite, Linnea Elevate, Linnea and Matrix double benches.	

Accessories Power Modules

Lead Time: Standard (All products are manufactured to order and when 'Standard Lead Time' is quoted (7 – 10 days), this may vary dependant on volume ordered, factory capacity and distribution requirements at the time of ordering. For more information please contact your Dealer Business Manager or the Customer Services Team for clarification.)

Metalwork: Available in Silver RAL 9006 (Standard), Black Graphite RAL 9004, White RAL 9003, Chrome Effect (Add 15%) and Raw finish (Add 5%)

Finish: Capsule: Available with Black and White

Guarantee: 1 Year Guarantee on All Electrical Items



CAP/2P/W

Capsule Desktop Power and Media Module

- 2x 3 amp switched sockets with resettable thermal fuses.
- 1x USB twin charger (type A+C).
- 2x data blanks.
- Power and connection lead to 3 pole connector.
- Cables exit from unit back.
- Optional desktop clamps available (see below).
- Requires a separate mains lead if connecting directly into a socket (see page 319).

Price

CAP/2P/B - 2x Power, 1x USB Twin Charger, 2x Blanks - Black _____

£149

CAP/2P/W - 2x Power, 1x USB Twin Charger, 2x Blanks - White _____

£149



CAP/2P/B
Black Plastic
3 Week Lead Time



CAP/2P/W
White Plastic
3 Week Lead Time



CAPDPC2

Capsule Desktop Power Module Fixing Clamp

- Compatible with Capsule power modules.
- Clamps modules to chosen desks.

Metalwork

CAPDPC1 - Capsule _____

£13

- For Single Desks: Progress Plus, Progress, Linnea Elevate, Linnea and Matrix single desks. Kassini, Optima Plus, Reflex, Callisto, Windsor, Flexi entire ranges.

CAPDPC2 - Capsule _____

£13

- For Double Bench Desks: Progress Plus, Progress, Progress Lite, Linnea Elevate, Linnea and Matrix double benches.

Accessories Power Modules

Lead Time: Standard (All products are manufactured to order and when 'Standard Lead Time' is quoted (7 – 10 days), this may vary dependant on volume ordered, factory capacity and distribution requirements at the time of ordering. For more information please contact your Dealer Business Manager or the Customer Services Team for clarification.)

Finish: Plaza: Available with Black or White

Finish: Boost: Available with Black Body and Silver Trim

Guarantee: 1 Year Guarantee on All Electrical Items



POW/PLA/2P1T/B

Plaza Desktop Power and Media Module

- 2x 3 amp sockets with resettable thermal fuses. • 1x USB twin charger (type A+C).
- 500mm power and connection lead to 3 pole connector.
- Cables exit from unit back. • Fixed desktop clamp.
- Requires a separate mains lead if connecting directly into a socket (see page 319).
- For compatibility, see page 323-324.

POW/PLA/2P1T/B - 2x Power, 1x USB Twin Charger - Black _____

POW/PLA/2P1T/W - 2x Power, 1x USB Twin Charger - White _____

Price

£146

£146



POW/PLA/2P1T/B
Black Plastic



POW/PLA/2P1T/W
White Plastic



PLADPC1

Plaza Desktop Power Module Fixing Clamp

- Compatible with Plaza power modules. • Clamps modules to chosen desks.

Metalwork

PLADPC1 - Plaza _____

£13



POW/BOO/2P1T/S

Boost Desktop Power and Media Module

- 2x 3 amp switched sockets with resettable thermal fuses. • 1x USB twin charger (type A+A).
- 500mm power and connection lead to 3 pole connector.
- Cables exit from unit back. • Fixed desktop clamp.
- Requires a separate mains lead if connecting directly into a socket (see page 319).
- For compatibility, see page 323-324.

POW/BOO/2P1T/S - 2x Power, 1x USB Twin Charger - Silver _____

Price

£151

Accessories Power Modules and Accessories

Lead Time: Standard (All products are manufactured to order and when 'Standard Lead Time' is quoted (7 – 10 days), this may vary dependant on volume ordered, factory capacity and distribution requirements at the time of ordering. For more information please contact your Dealer Business Manager or the Customer Services Team for clarification.)

Finish: Wieland: Available with Black Body Only

Guarantee: 1 Year Guarantee on All Electrical Items



SK3/U

Wieland Socket Box

- 3.15 amp Individually fused unswitched black sockets.
- Complete with 250mm earth lead to M5 ring terminal.
- Requires a separate mains lead if connecting directly into a socket (see below).

	Price
SK2/U - 2 Gang - Black - 262w x 60d x 50h	£30
SK3/U - 3 Gang - Black - 262w x 60d x 50h	£34
SK4/U - 4 Gang - Black - 315w x 60d x 50h	£42



AFK

Adhesive Fixing Kit

- Enables freestanding power modules to be attached to the desk top.
- 1x kit required per module.

	Price
AFK	£5



2WA

2 Way Adapter

- Allows power supply to be split between multiple power modules.

	Price
2WA	£30



3WA

3 Way Adaptor

- Allows power supply to be split between multiple power modules.

	Price
3WA	£18



5M

Wieland Mains Cable

- Black plug.

	Price
7M - 7000w	£31
5M - 5000w	£24
3M - 3000w	£19
2M - 2000w	£17



CL10

Wieland Interconnection Cable

- Black interconnection plugs.

	Price
CL20 - 2000w	£15
CL10 - 1000w	£13
CL5 - 500w	£12

Accessories Monitor Arms

Lead Time: Standard (All products are manufactured to order and when 'Standard Lead Time' is quoted (7 – 10 days), this may vary dependant on volume ordered, factory capacity and distribution requirements at the time of ordering. For more information please contact your Dealer Business Manager or the Customer Services Team for clarification.)



2LM2BS

M2 Monitor Arm

- Post mounted monitor arm with spring assisted tension.

2LM2CS/TFC - Silver Clamp on Desk Fixing _____

2LM2CW/TFC - White Clamp on Desk Fixing _____

- Spring Assisted Tension Height Adjustment

2LM2BS - Silver Bolt through Desk Fixing _____

2LM2BW - White Bolt through Desk Fixing _____

- Spring Assisted Tension Height Adjustment

Price

£304

£304

£304

£304



F2LMPBT

Flex Monitor Arm

- Post mounted monitor arm with 2x folding links.

F2LMP - Silver Clamp on Desk Fixing _____

F2LMP/W - White Clamp on Desk Fixing _____

- Manual Post Height Adjustment

F2LMPBT - Silver Bolt through Desk Fixing _____

F2LMPBT/W - White Bolt through Desk Fixing _____

- Manual Post Height Adjustment

F2LGP - Silver Clamp on Desk Fixing _____

F2LGP/W - White Clamp on Desk Fixing _____

- Front End Height Adjustment

F2LGPBT - Silver Bolt through Desk Fixing _____

F2LGPBT/W - White Bolt through Desk Fixing _____

- Front End Height Adjustment

F2LGS - Management Rail Screen Mounted Silver Clamp _____

F2LGS/W - Management Rail Screen Mounted White Clamp _____

- Front End Height Adjustment

Price

£180

£180

£180

£180

£227

£227

£227

£227

£190

£190



F2LGPBT



F2LGS

Accessories Monitor Arms

Lead Time: Standard (All products are manufactured to order and when 'Standard Lead Time' is quoted (7 – 10 days), this may vary dependant on volume ordered, factory capacity and distribution requirements at the time of ordering. For more information please contact your Dealer Business Manager or the Customer Services Team for clarification.)



MOA/ASC1/W

Ascend Monitor Arm

- Post mounted monitor arm with gas assisted fingertip adjustment.

Price

MOA/ASC1/S	- Silver Clamp on Desk Fixing	_____	£270
MOA/ASC1/B	- Black Clamp on Desk Fixing	_____	£270
MOA/ASC1/W	- White Clamp on Desk Fixing	_____	£287
• Gas Assisted Fingertip Adjustment			
MOA/ASC1RM/S	- Management Rail Screen Mounted Silver Clamp	_____	£270
MOA/ASC1RM/B	- Management Rail Screen Mounted Black Clamp	_____	£270
MOA/ASC1RM/W	- Management Rail Screen Mounted White Clamp	_____	£287
• Gas Assisted Fingertip Adjustment			



MOA/OLL1/S

Ollin Monitor Arm

- Post mounted monitor arm with innovative 'technical cord' system.

Price

MOA/OLL1/S	- Silver Clamp on Desk Fixing	_____	£322
MOA/OLL1/B	- Black Clamp on Desk Fixing	_____	£322
MOA/OLL1/W	- White Clamp on Desk Fixing	_____	£322
• 'Technical Cord' System Height Adjustment			



MOA/FLO1/S

Flo Monitor Arm

- Post mounted monitor arm with 'Flo spring technology' and fingertip height adjustment.

Price

MOA/FLO1/S	- Silver Clamp on Desk Fixing	_____	£279
MOA/FLO1/B	- Black Clamp on Desk Fixing	_____	£279
MOA/FLO1/W	- White Clamp on Desk Fixing	_____	£279
• 'Flo Spring Technology' Fingertip Height Adjustment			

Accessories Monitor Arms

Lead Time: Standard (All products are manufactured to order and when 'Standard Lead Time' is quoted (7 – 10 days), this may vary dependant on volume ordered, factory capacity and distribution requirements at the time of ordering. For more information please contact your Dealer Business Manager or the Customer Services Team for clarification.)



M8S3WCB

M8 Dual Monitor Arm

- 4 week lead time.
- Not compatible with the Matrix range.
- The M8 accommodates two monitors with the use of a crossbar support, each weighing up to 9kg, a maximum total of 18kg's.
- Clamp fixing to a 25mm desk top only.

M8S3SCB - Silver Clamp on Desk Fixing _____

M8S3WCB - White Clamp on Desk Fixing _____

- Spring Assisted Tension Height Adjustment

Price

£635

£635



F4LGP

Flex Dual Monitor Arm

- Double arm, each with 2x folding links.
- Manual post height adjustment and front end adjustment.

F4LGP - Silver Clamp on Desk Fixing _____

F4LGP/W - White Clamp on Desk Fixing _____

- Manual Post and Front End Height Adjustment

Price

£495

£495



MOA/ASC2/W

Ascend Dual Monitor Arm

- Double arm, each with 2x folding links.
- Post mounted monitor arm with gas assisted fingertip adjustment.

MOA/ASC2/S - Silver Clamp on Desk Fixing _____

MOA/ASC2/B - Black Clamp on Desk Fixing _____

MOA/ASC2/W - White Clamp on Desk Fixing _____

- Gas Assisted Fingertip Adjustment

Price

£524

£524

£545



MOA/OLL2/B

Ollin Dual Monitor Arm

- Double arm, tilt adjustment of monitors via a central adjuster knob.
- Post mounted monitor arm with innovative 'technical cord' system.

MOA/OLL2/S - Silver Clamp on Desk Fixing _____

MOA/OLL2/B - Black Clamp on Desk Fixing _____

MOA/OLL2/W - White Clamp on Desk Fixing _____

- Technical Cord System Height Adjustment

Price

£505

£505

£505

Accessories Accessory Compatibility

- **BLACK** - Compatible
- **ORANGE** - Non-standard position required
- **BLUE** - Conflict when using screens
- **RED** - May not support larger modules
- **GREEN** - Unspecified

	Power and Data Modules							Monitor Arms						
	Kaspa and Prime, page 309	Boardroom, Conus and Peak, page 310-312	Escalate, page 312	Wireless Charging Unit, page 313	Port Hole and Pix, page 314	Pluto and Inca, page 315	Flex and Capsule, page 316-317	Plaza and Boost, page 318	Wieland Socket Boxes, page 319	M2, page 320	Flex, page 320-322	Ascend, page 321-322	Ollin and Flo, page 321-322	M8, page 322
Progress Plus - Double Benches				●	●	●	●	●	●	●	●	●	●	●
Progress Plus - Single Desks			●	●	●	●	●	●	●	●	●	●	●	●
Progress Plus - 120 Degree Workstations			●	●	●	●	●	●	●	●	●	●	●	●
Progress Plus - Conference / Meeting	●	●	●	●	●	●	●	●	●	●	●	●	●	●
Progress - Double Benches				●	●	●	●	●	●	●	●	●	●	●
Progress - Single Desks			●	●	●	●	●	●	●	●	●	●	●	●
Progress - 120 Degree Workstations			●	●	●	●	●	●	●	●	●	●	●	●
Progress - Conference / Meeting			●	●	●	●	●	●	●	●	●	●	●	●
Progress Lite - Double Benches			●	●	●	●	●	●	●	●	●	●	●	●
Linnea Elevate - Double Benches			●	●	●	●	●	●	●	●	●	●	●	●
Linnea Elevate - Single Desks						●	●	●	●	●	●	●	●	●
Lux - Double Benches			●	●	●	●	●	●	●	●	●	●	●	●
Lux - Single Desks	●	●	●	●	●	●	●	●	●	●	●	●	●	●
Lux - Conference / Meeting (Excluding 1000w Circular)	●	●	●	●	●	●	●	●	●	●	●	●	●	●
Lux - 1000w Circular	●	●	●	●	●	●	●	●	●	●	●	●	●	●
Lux - Benches	●	●	●	●	●	●	●	●	●	●	●	●	●	●
Reflex - Single Desks			●	●	●	●	●	●	●	●	●	●	●	●
Reflex - Managers Workstations			●	●	●	●	●	●	●	●	●	●	●	●
Reflex - Conference / Meeting (Excluding 1000w Circular)	●	●	●	●	●	●	●	●	●	●	●	●	●	●
Reflex - 1000w Circular	●	●	●	●	●	●	●	●	●	●	●	●	●	●
Linnea - Double Benches			●	●	●	●	●	●	●	●	●	●	●	●
Linnea - Single Desks			●	●	●	●	●	●	●	●	●	●	●	●
Linnea - Radius Reception			●	●	●	●	●	●	●	●	●	●	●	●
Linnea - 120 Degree Workstations			●	●	●	●	●	●	●	●	●	●	●	●
Linnea - Conference / Meeting	●	●	●	●	●	●	●	●	●	●	●	●	●	●
Matrix - Double Benches			●	●	●	●	●	●	●	●	●	●	●	●
Matrix - Single Desks	●	●	●	●	●	●	●	●	●	●	●	●	●	●
Matrix - Managers Workstations	●	●	●	●	●	●	●	●	●	●	●	●	●	●
Matrix - 120 Degree Workstations			●	●	●	●	●	●	●	●	●	●	●	●
Matrix - Conference / Meeting	●	●	●	●	●	●	●	●	●	●	●	●	●	●

Accessories Accessory Compatibility

- **BLACK** - Compatible
- **ORANGE** - Non-standard position required
- **BLUE** - Conflict when using screens
- **RED** - May not support larger modules
- **GREEN** - Unspecified

	Power and Data Modules							Monitor Arms						
	Kaspa and Prime, page 309	Boardroom, Conus and Peak, page 310-312	Escalate, page 312	Wireless Charging Unit, page 313	Port Hole and Pix, page 314	Pluto and Inca, page 315	Flex and Capsule, page 316-317	Plaza and Boost, page 318	Wieland Socket Boxes, page 319	M2, page 320	Flex, page 320-322	Ascend, page 321-322	Ollin and Flo, page 321-322	M8, page 322
Kassini - Single Desks	●	●	●	●	●	●	●	●	●	●	●	●	●	
Kassini - Bow Fronted Desking	●	●	●	●	●	●	●	●	●	●	●	●	●	
Kassini - 120 Degree Workstations	●	●	●	●	●	●	●	●	●	●	●	●	●	
Kassini - Kidney / Radius Reception / Reception	●	●	●	●	●	●	●	●	●	●	●	●	●	
Optima Plus - Single Desks	●	●	●	●	●	●	●	●	●	●	●	●	●	
Optima Plus - Bow Fronted Desking	●	●	●	●	●	●	●	●	●	●	●	●	●	
Optima Plus - 120 Degree Workstations	●	●	●	●	●	●	●	●	●	●	●	●	●	
Optima Plus - Kidney / Radius Reception / Reception	●	●	●	●	●	●	●	●	●	●	●	●	●	
Optima Plus - Conference / Meeting	●	●	●	●	●	●	●	●	●	●	●	●	●	
Callisto - Single Desks	●	●	●	●	●	●	●	●	●	●	●	●	●	
Callisto - Bow Fronted Desking	●	●	●	●	●	●	●	●	●	●	●	●	●	
Callisto - 120 Degree Workstations	●	●	●	●	●	●	●	●	●	●	●	●	●	
Callisto - Kidney / Radius Reception / Reception	●	●	●	●	●	●	●	●	●	●	●	●	●	
Callisto - Conference / Meeting	●	●	●	●	●	●	●	●	●	●	●	●	●	
Windsor - Single Desks	●	●	●	●	●	●	●	●	●	●	●	●	●	
Windsor - Bow Fronted Desking	●	●	●	●	●	●	●	●	●	●	●	●	●	
Windsor - Bow Fronted Reception	●	●	●	●	●	●	●	●	●	●	●	●	●	
Windsor - Radius Reception	●	●	●	●	●	●	●	●	●	●	●	●	●	
Windsor - Conference / Meeting	●	●	●	●	●	●	●	●	●	●	●	●	●	
Flexi - Single Desks	●	●	●	●	●	●	●	●	●	●	●	●	●	
Flexi - 120 Degree Workstations	●	●	●	●	●	●	●	●	●	●	●	●	●	
Call Centre - Circular Call Centre	●	●	●	●	●	●	●	●	●	●	●	●	●	
Call Centre - Semi-Circular Call Centre	●	●	●	●	●	●	●	●	●	●	●	●	●	
Interact - Collaborative	●	●	●	●	●	●	●	●	●	●	●	●	●	

Accessories Lighting

Lead Time: Standard (All products are manufactured to order and when 'Standard Lead Time' is quoted (7 – 10 days), this may vary dependant on volume ordered, factory capacity and distribution requirements at the time of ordering. For more information please contact your Dealer Business Manager or the Customer Services Team for clarification.)



LGT/SUP/BM/B

Supa Lamp

- 10 year, 24/7 warranty. • Touchstrip dimmable. • 7 watts energy consumption.
- 3000K (warm white) to 4000K (cool white) colour temperature.
- Energy saving auto off when no movement is detected.

				Price
LGT/SUP/BM/G	- Grey	- Base Mounted	_____	£666
LGT/SUP/BM/B	- Black	- Base Mounted	_____	£666
LGT/SUP/BM/W	- White	- Base Mounted	_____	£666
LGT/SUP/RM/G	- Grey	- Management Rail Screen Mounted	_____	£653
LGT/SUP/RM/B	- Black	- Management Rail Screen Mounted	_____	£653
LGT/SUP/RM/W	- White	- Management Rail Screen Mounted	_____	£653



LGT/POP/BM/W

Pop Lamp

- 1 year warranty. • 4-stage dimmable. • 5 watts energy consumption.
- 3700K to 5000K (neutral white) colour temperature. • 1x USB twin charger (type A+C).
- Energy saving auto off after 4 hours. • 36 degree angled head.

				Price
LGT/POP/BM/B	- Black	- Base Mounted	_____	£332
LGT/POP/BM/W	- White	- Base Mounted	_____	£332



ZBARS

Mini Z-Bar Lamp

- 1 year warranty. • Touchstrip dimmable. • 6.5 watts energy consumption.
- 3500K to 45000K colour temperature. • Three bar design provides ultimate flexibility.

				Price
ZBARS	- Silver	- Base Mounted	_____	£438
ZBARB	- Black	- Base Mounted	_____	£438
ZBARW	- White	- Base Mounted	_____	£438
ZBARS/RM	- Silver	- Management Rail Screen Mounted	_____	£454
ZBARB/RM	- Black	- Management Rail Screen Mounted	_____	£454
ZBARW/RM	- White	- Management Rail Screen Mounted	_____	£454



ZBAR/WCUS

Mini Z-Bar Aircharge Lamp

- 1 year warranty. • Touchstrip dimmable. • 7 watts energy consumption.
- 3500K (warm white) to 5000K (daylight) colour temperature. • In-built wireless charger.
- Three bar design provides ultimate flexibility.

				Price
ZBAR/WCUS	- Silver	- Base Mounted	_____	£519
ZBAR/WCUB	- Black	- Base Mounted	_____	£519
ZBAR/WCUW	- White	- Base Mounted	_____	£519

Accessories Various

Lead Time: Standard (All products are manufactured to order and when 'Standard Lead Time' is quoted (7 – 10 days), this may vary dependant on volume ordered, factory capacity and distribution requirements at the time of ordering. For more information please contact your Dealer Business Manager or the Customer Services Team for clarification.)



ET16

Universal Cable Trunking

- 3x channel electrical trunking.
- Black PVC with self adhesive fixing.
- Cables simply push in.
- Suitable for all desking ranges.

Price

ET18 - 1500w x 80d x 22h	_____	£63
ET16 - 1300w x 80d x 22h	_____	£54
ET14 - 1100w x 80d x 22h	_____	£43
ET12 - 900w x 80d x 22h	_____	£40



SCR/S - SCR/B - SCR/W

Slinky Cable Riser

- Suitable for all desking ranges.

Price

SCR/S - Silver	_____	£59
SCR/B - Black	_____	£59
SCR/W - White	_____	£59



MCPU

Mobile CPU Holder

- Adjustable bracket to hold 180mm - 240mm wide CPU towers.
- Suitable for all desking ranges.

Price

MCPU	_____	£137
-------------	-------	------



CPUW - CPU

CPU Holder

- Includes mounting kit.
- Adjustable CPU holder for PC towers.
- Rotates a full 360 degrees for complete access to cables and ports.

Price

CPU - Black - 76-254w x 305-508h	_____	£169
CPUW - White - 76-254w x 305-508h	_____	£169



DTM

Desktop Mat

- Heavy duty black polyurethane with 90 degree lipped edge.

Price

DTM - 635w x 465d x 20h	_____	£156
--------------------------------	-------	------



FL (Underside of Desks)

Fixing Link

- Enables freestanding workstation surfaces to be linked together.
- Supplied in packs of 20, including wood screws.

Price

FL - Pack of 20	_____	£8
------------------------	-------	----

Dimensions

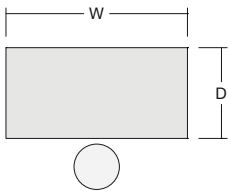

Rectangular Desk

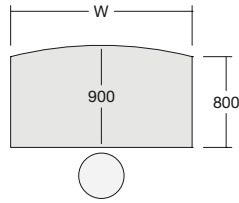

Bow Fronted Rectangular Desk

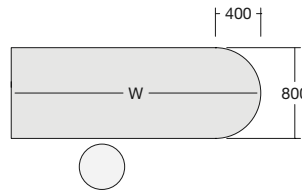

D Ended Rectangular Desk

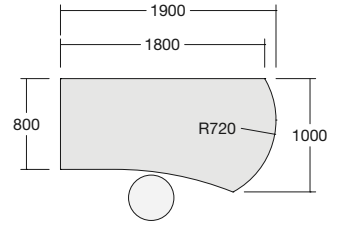

Radius Executive Rectangular Desk

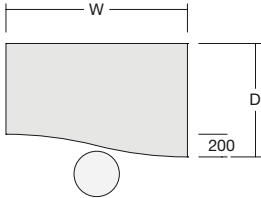

Wave Desk

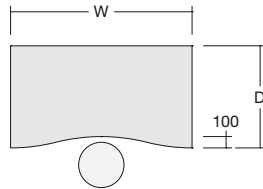

Double Wave Desk

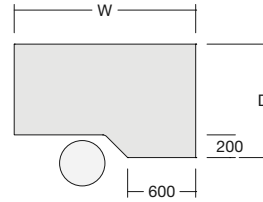

Angular Workstation

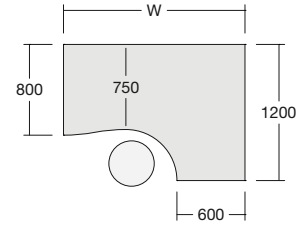

Crescent Workstation

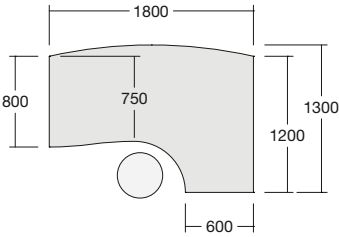

Bow Fronted Crescent Workstation

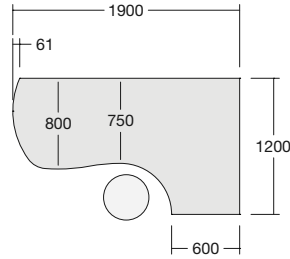

Radius Executive Crescent Workstation

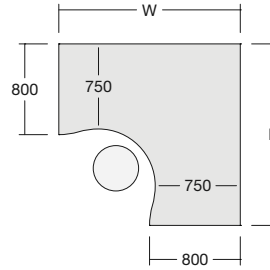

Symmetrical Crescent Workstation

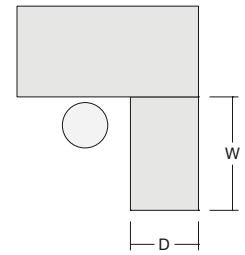

Secretarial Return

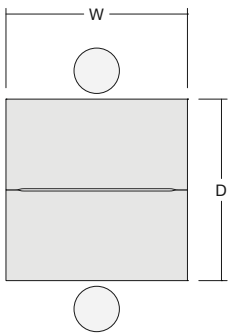

Double Bench

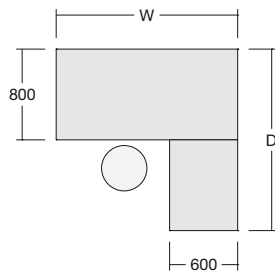

Managers Workstation

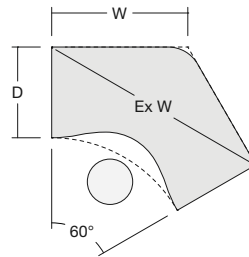

Single 120 Degree Workstation

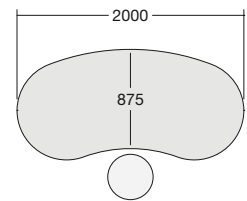

Kidney Desk

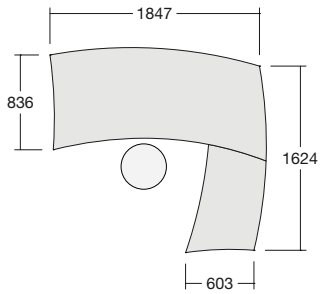

Radius Crescent Reception Desk

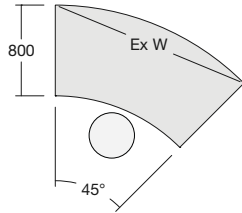

Radius Reception Desk

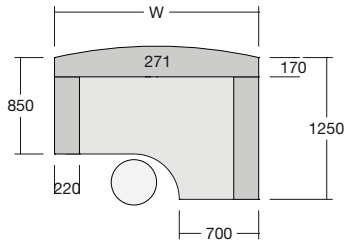

Windsor Bow Fronted Reception Desk

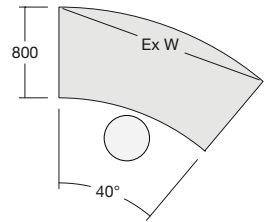

Windsor Radius Reception Desk

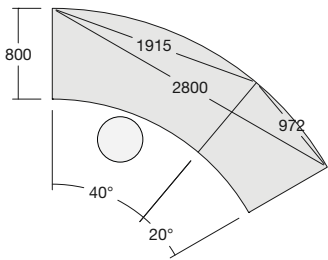

Windsor Radius Reception Desk with DDA Extension

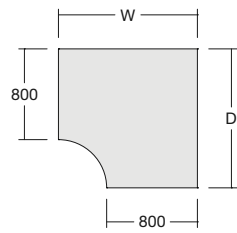

Linking Workstation

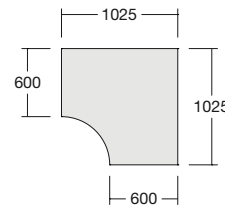

Linking Workstation

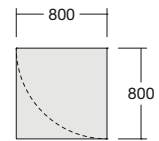

Linking Workstation

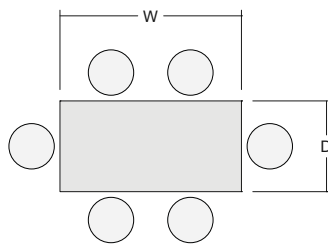

Rectangular Table

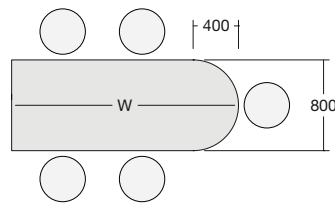

D Ended Rectangular Table

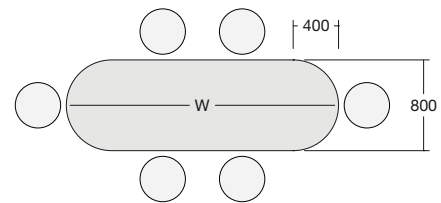

Double D Ended Rectangular Table

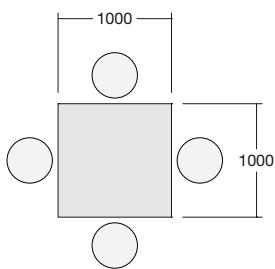

Square Table

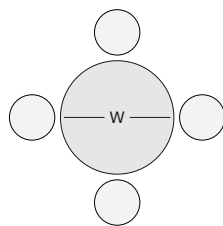

Circular Table

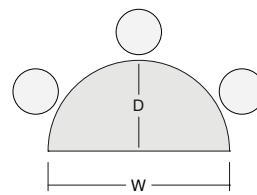

Semi-circular Table

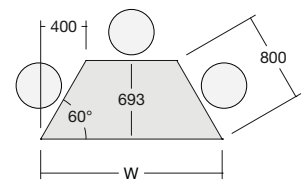

Trapezoidal Table

Terms and Conditions

INTERPRETATION

- In these Conditions, the following definitions apply:
"Business Day" means a day (other than a Saturday, Sunday or public holiday) when banks in London are open for business;
"Conditions" means the terms and conditions set out in this document as amended from time to time in accordance with clause 52;
"Contract" means the contract between EOF and the Customer for the sale and purchase of the Goods in accordance with these Conditions;
"Customer" means the person or firm who purchases the Goods from EOF;
"EOF" means Elite Office Furniture (UK) Ltd. a company incorporated in England and Wales with company number 03365655;
"Force Majeure Event" means has the meaning given in clause 46;
"Goods" means the goods (or any part of them) set out in the Order;
"Order" means the Customer's order for the Goods, as set out [in the Customer's purchase order form OR overleaf OR in the Customer's written acceptance of the EOF's quotation OR in the Customer's purchase order form, the Customer's written acceptance of EOF's quotation];
"Specials" means any bespoke products manufactured or otherwise supplied by EOF to the Customer's Specification; and
"Specification" means any specification for the Goods agreed between the parties in accordance with clause 9.
- In these Conditions:
 - a person includes a natural person, corporate or unincorporated body (whether or not having separate legal personality);
 - a reference to a party includes its personal representatives, successors or permitted assigns;
 - a reference to a statute or statutory provision is a reference to such statute or provision as amended or re-enacted. A reference to a statute or statutory provision includes any subordinate legislation made under that statute or statutory provision, as amended or re-enacted;
 - any phrase introduced by the terms including, include, in particular or any similar expression shall be construed as illustrative and shall not limit the sense of the words preceding those terms; and
 - a reference to writing or written includes faxes and e-mails.

BASIS OF THE CONTRACT

- These Conditions apply to the Contract to the exclusion of any other terms that the Customer seeks to impose or incorporate, or which are implied by trade, custom, practice or course of dealing. The Order constitutes an offer by the Customer to purchase the Goods in accordance with these Conditions.
- The Order shall only be deemed to be accepted when EOF issues a written acceptance of the Order, at which point the Contract shall come into existence. The Customer is responsible for ensuring that the terms of the Order and any applicable Specification are complete and accurate. The Customer must communicate any errors to EOF's Customer Services Team within 24 hours (and confirmed in writing within 48 hours) and accepts that failure to do will render them liable for potential abortive costs.
- The Contract constitutes the entire agreement between the parties. The Customer acknowledges that it has not relied on any statement, promise or representation made or given by or on behalf of EOF which is not set out in the Contract.
- Any samples, drawings, descriptive matter, or advertising produced by EOF and any descriptions or illustrations contained in EOF's catalogues, brochures and website are produced for the sole purpose of giving an approximate idea of the Goods described in them. They shall not form part of the Contract or have any contractual force.
- A quotation for the Goods given by EOF shall not constitute an offer. A quotation shall only be valid for a period of 30 Business Days from its date of issue.

PRODUCTS

- The Goods are, subject to clause 6, as described in EOF's catalogue as modified by any applicable Specification.
- Requests for Special product(s) must be submitted on the official 'Elite Specials Request Form' which is available via the Elite web site or on request from EOF's Customer Services Department. When submitted the document will be processed by the Elite Specials team and a decision will be made either to accept or reject the request based on its validity and feasibility. It is EOF's aim to return completed forms within 2 – 3 Business Days.
- To the extent that the Goods are to be manufactured in accordance with a Specification supplied by the Customer, the Customer shall indemnify EOF against all liabilities, costs, expenses, damages and losses (including any direct, indirect or consequential losses, loss of profit, loss of reputation and all interest, penalties and legal and other professional costs and expenses) suffered or incurred by EOF in connection with any claim made against EOF for actual or alleged infringement of a third party's intellectual property rights arising out of or in connection with EOF's use of the Specification. This clause 10 shall survive termination of the Contract.

- EOF reserves the right to discontinue the manufacture or supply of the Goods or amend the specification of the Goods without notice:
 - if required by any applicable statutory or regulatory requirements; or
 - in accordance with its policy of continuous product development.

CANCELLATIONS AND VARIATIONS

- It is in EOF's sole discretion, having regard to any agreed delivery dates, when to commence manufacture of the Goods. Cancellations must be communicated to EOF in writing. Cancellations received by EOF:
 - prior to manufacture may, in EOF's sole discretion, be subject to a 25% administration cost (such cost being a genuine pre-estimate of the cost of, amongst other things, the rescheduling of production runs);
 - following commencement of manufacture will be charged in full;
 - in respect of outsourced Goods (i.e. not manufactured by EOF) shall be subject to a 25% administration cost (such cost being a genuine pre-estimate of EOF cancelling its order with any third party supplier), please note that whilst EOF may, but shall be under no obligation so to do, have regard to the stage of production reached when receiving the Customer's notice of cancellation when determining cancellation costs it reserves the right to charge for cancellations in full. Specials shall always be charged in full.
- If the Customer wishes to change anything in the Contract, the request must be made in writing. EOF will inform the Customer whether it is willing to agree to the change and, if so, what will be the impact on the price and delivery date. The Customer must notify EOF in writing within 2 days of receiving EOF's response whether these changes are accepted and if so, the Contract will be deemed to have been varied accordingly. EOF will not proceed with the change until this notice is received. A request to reduce the quantity of Goods ordered will not result in a price reduction unless otherwise agreed in writing by EOF.

DELIVERY

- EOF shall ensure that:
 - each delivery of the Goods is accompanied by a delivery note which shows the date of the Order, all relevant Customer and EOF reference numbers, the type and quantity of the Goods (including the code number of the Goods, where applicable), special storage instructions (if any) and, if the Order is being delivered by instalments, the outstanding balance of Goods remaining to be delivered; and
 - if EOF requires the Customer to return any packaging materials to EOF, that fact is clearly stated on the delivery note. The Customer shall make any such packaging materials available for collection at such times as EOF shall reasonably request. Returns of packaging materials shall be at EOF's expense.
- EOF shall deliver the Goods to the location set out in the Order (one address only) or such other location as the parties may agree ("Delivery Location") at any time after EOF notifies the Customer that the Goods are ready. Delivery requests for alternative addresses will be charged at a minimum of £110.00 and must be approved by EOF's Customer Services Team prior to placing the Order. EOF reserves the right to decline any such request.
- Delivery of the Goods shall be completed on the Goods' arrival at the Delivery Location and in the case of ex-works on EOF notifying the Customer that the Goods are ready for collection. All deliveries must be signed for & appropriately dated. Items cannot be signed unchecked, it is the Customer's responsibility to visually check items delivered and investigate items where the packaging is visibly damaged or torn. Deliveries are inclusive of tailboard only where it is the Customer's responsibility to provide free assistance in unloading the vehicle. Once unloaded to the tailboard of the vehicle and handed to the Customer, it is their responsibility from here on. Notification of shortages and/or damages must be made in writing to EOF within 3 days of delivery.
- Any dates quoted for delivery are approximate only, and the time of delivery is not of the essence. EOF shall not be liable for any delay in delivery of the Goods that is caused by a Force Majeure Event or the Customer's failure to provide EOF with adequate delivery instructions or any other instructions that are relevant to the supply of the Goods. EOF deliver on multi-drop vehicles and no guarantee can be made to set timescales. However, if the volume permits a dedicated delivery can be made (subject to additional costs) and an estimated time of delivery can be requested. In such cases EOF will not be liable for financial penalties resulting in late delivery of products.
- EOF shall have no liability for any failure to deliver the Goods to the extent that such failure is caused by a Force Majeure Event or the Customer's failure to provide EOF with adequate delivery instructions or any other instructions that are relevant to the supply of the Goods.

- If the Customer fails to take delivery of the Goods within 3 Business Days of EOF notifying the Customer that the Goods are ready, then, except where such failure or delay is caused by a Force Majeure Event or EOF's failure to comply with its obligations under the Contract:
 - delivery of the Goods shall be deemed to have been completed at 9.00 am on the third Business Day after the day on which EOF notified the Customer that the Goods were ready; and
 - EOF shall store the Goods until delivery takes place, and charge the Customer for all related costs and expenses (including insurance, storage and redelivery).

- If 10 Business Days after the day on which EOF notified the Customer that the Goods were ready for delivery the Customer has not taken delivery of them, EOF may resell or otherwise dispose of part or all of the Goods and, after deducting reasonable storage and selling costs, account to the Customer for any excess over the price of the Goods paid by the Customer or charge the Customer for any shortfall below the price of the Goods.
- EOF may deliver the Goods by instalments, which shall be invoiced and paid for separately. Each instalment shall constitute a separate Contract. Any delay in delivery or defect in an instalment shall not entitle the Customer to cancel any other instalment.

QUALITY/RETURNS

- EOF warrants that on delivery, and for a period of 5 years from the date of delivery ("Warranty Period"), the Goods shall:
 - conform in all material respects with their description and any applicable Specification;
 - be free from material defects in design, material and workmanship; and
 - be of satisfactory quality (within the meaning of the Sale of Goods Act 1979); and
 - be fit for any purpose held out by EOF.
- Subject to clause 24 if:
 - the Customer gives notice in writing to EOF during the Warranty Period within a reasonable time of discovery that some or all of the Goods do not comply with the warranty set out in clause 22;
 - EOF is given a reasonable opportunity of examining such Goods; and
 - the Customer (if asked to do so by EOF) returns such Goods to EOF's place of business at EOF's cost, EOF shall, at its option, repair or replace the defective Goods, or refund the price of the defective Goods in full.
- EOF shall not be liable for the Goods' failure to comply with the warranty set out in clause 22 in any of the following events:
 - the Customer makes any further use of such Goods after giving notice in accordance with clause 22;
 - the defect arises because the Customer failed to follow EOF's oral or written instructions as to the storage, commissioning, installation, use and maintenance of the Goods or (if there are none) good trade practice regarding the same;
 - the defect arises as a result of EOF following any drawing, design or Specification supplied by the Customer;
 - the Customer alters or repairs such Goods without EOF's prior written consent;
 - the defect arises as a result of fair wear and tear, wilful damage, negligence, or abnormal storage or working conditions; or
 - the Goods differ from their description or, as the case may be, the Specification as a result of changes made to ensure they comply with applicable statutory or regulatory requirements.
- Wood veneers vary in grain and colour, EOF do not book match veneers and work with pre-veneered boards limiting the matching of veneers on adjoining surfaces. EOF will not be liable whatsoever for any variation and shall be under no obligation to accept return of Goods where a variation occurs. Veneer is a natural material and variations on pre-veneered board are inevitable. If the Customer requires book matching on veneers a specialist supplier should be identified and appointed.
- Except as provided in clauses 22 to 28 (inclusive), EOF shall have no liability to the Customer in respect of the Goods' failure to comply with the warranty set out in clause 22.
- Except as set out in these Conditions, all warranties, conditions and other terms implied by statute or common law are, to the fullest extent permitted by law, excluded from the Contract.
- These Conditions shall apply to any repaired or replacement Goods supplied by EOF.

TITLE AND RISK

29. The risk in the Goods shall pass to the Customer on completion of delivery.
30. Title to the Goods shall not pass to the Customer until EOF has received payment in full (in cash or cleared funds) for:
- 30.1 the Goods; and
- 30.2 any other goods or services that EOF has supplied to the Customer.
31. Until title to the Goods has passed to the Customer, the Customer shall:
- 31.1 hold the Goods on a fiduciary basis as EOF's bailee;
- 31.2 store the Goods separately from all other goods held by the Customer so that they remain readily identifiable as EOF's property;
- 31.3 not remove, deface or obscure any identifying mark or packaging on or relating to the Goods;
- 31.4 maintain the Goods in satisfactory condition and keep them insured against all risks for their full price from the date of delivery;
- 31.5 notify EOF immediately if it becomes subject to any of the events listed in clause 43; and
- 31.6 give EOF such information relating to the Goods as EOF may require from time to time, but the Customer may resell or use the Goods in the ordinary course of its business.
32. If before title to the Goods passes to the Customer the Customer becomes subject to any of the events listed in clause 43, or EOF reasonably believes that any such event is about to happen and notifies the Customer accordingly, then, provided that the Goods have not been resold, or irrevocably incorporated into another product, and without limiting any other right or remedy EOF may have, EOF may at any time require the Customer to deliver up the Goods and, if the Customer fails to do so promptly, enter any premises of the Customer or of any third party where the Goods are stored in order to recover them.

FINANCIAL - PRICES

33. The price of the Goods shall be the price set out in the Order, or, if no price is quoted, the price set out in EOF's published price list in force as at the date of delivery.
34. EOF may, by giving notice to the Customer at any time before delivery, increase the price of the Goods to reflect any increase in the cost of the Goods that is due to:
- 34.1 any factor beyond EOF's reasonable control (including foreign exchange fluctuations, increases in taxes and duties, and increases in labour, materials and other manufacturing costs);
- 34.2 any request by the Customer to change the delivery date(s), quantities or types of Goods ordered, or the Specification; or
- 34.3 any delay caused by any instructions of the Customer or failure of the Customer to give EOF adequate or accurate information or instructions.
35. The price of the Goods is inclusive of the costs and charges of packaging. (Export product will be subject to additional charges, please contact the Elite Customer Services for prices).
36. The price of the Goods is exclusive of amounts in respect of value added tax ("VAT"). The Customer shall, on receipt of a valid VAT invoice from EOF, pay to EOF such additional amounts in respect of VAT as are chargeable on the supply of the Goods.

FINANCIAL - PAYMENT

37. EOF requires 2 bank references for new account applications and reserves the right to change its financial requirements as and when it deems it appropriate.
38. EOF may invoice the Customer for the Goods on or at any time after the completion of delivery.
39. The Customer shall pay the invoice in full and in cleared funds by the end of the month following the month the invoice was dated. Time of payment is of the essence.
40. If the Customer fails to make any payment due to EOF under the Contract by the due date for payment ("due date"), then the Customer shall pay interest on the overdue amount at the rate of 2.5% per annum above [HSBC]'s base rate from time to time. Such interest shall accrue on a daily basis from the due date until the date of actual payment of the overdue amount, whether before or after judgment. The Customer shall pay the interest together with the overdue amount. EOF reserves the right to charge interest on any overdue payment in accordance with the Late Payment of Commercial Debts (Interest) Act 1998. The Customer shall be liable for all reasonable costs (including legal and court costs) associated with the collection of overdue accounts.

41. The Customer shall pay all amounts due under the Contract in full without any deduction or withholding except as required by law and the Customer shall not be entitled to assert any credit, set-off or counterclaim against EOF in order to justify withholding payment of any such amount in whole or in part. EOF may at any time, without limiting any other rights or remedies it may have, set off any amount owing to it by the Customer against any amount payable by EOF to the Customer.

CUSTOMER'S INSOLVENCY OR INCAPACITY

42. If the Customer becomes subject to any of the events listed in clause 43, or EOF reasonably believes that the Customer is about to become subject to any of them and notifies the Customer accordingly, then, without limiting any other right or remedy available to EOF, EOF may cancel or suspend all further deliveries under the Contract or under any other contract between the Customer and EOF without incurring any liability to the Customer, and all outstanding sums in respect of Goods delivered to the Customer shall become immediately due.
43. For the purposes of clause 42, the relevant events are:
- 43.1 the Customer suspends, or threatens to suspend, payment of its debts, or is unable to pay its debts as they fall due or admits inability to pay its debts, or (being a company) is deemed unable to pay its debts within the meaning of section 123 of the Insolvency Act 1986, or (being an individual) is deemed either unable to pay its debts or as having no reasonable prospect of so doing, in either case, within the meaning of section 268 of the Insolvency Act 1986, or (being a partnership) has any partner to whom any of the foregoing apply;
- 43.2 the Customer commences negotiations with all or any class of its creditors with a view to rescheduling any of its debts, or makes a proposal for or enters into any compromise or arrangement with its creditors other than (where the Customer is a company) where these events take place for the sole purpose of a scheme for a solvent amalgamation of the Customer with one or more other companies or the solvent reconstruction of the Customer;
- 43.3 (being a company) a petition is filed, a notice is given, a resolution is passed, or an order is made, for or in connection with the winding up of the Customer, other than for the sole purpose of a scheme for a solvent amalgamation of the Customer with one or more other companies or the solvent reconstruction of the Customer;
- 43.4 (being an individual) the Customer is the subject of a bankruptcy petition or order;
- 43.5 a creditor or encumbrancer of the Customer attaches or takes possession of, or a distress, execution, sequestration or other such process is levied or enforced on or sued against, the whole or any part of its assets and such attachment or process is not discharged within 14 days;
- 43.6 (being a company) an application is made to court, or an order is made, for the appointment of an administrator or if a notice of intention to appoint an administrator is given or if an administrator is appointed over the Customer;
- 43.7 (being a company) a floating charge holder over the Customer's assets has become entitled to appoint or has appointed an administrative receiver;
- 43.8 a person becomes entitled to appoint a receiver over the Customer's assets or a receiver is appointed over the Customer's assets;
- 43.9 any event occurs, or proceeding is taken, with respect to the Customer in any jurisdiction to which it is subject that has an effect equivalent or similar to any of the events mentioned in clause 43.1 to clause 43.8 (inclusive);
- 43.10 the Customer suspends, threatens to suspend, ceases or threatens to cease to carry on all or substantially the whole of its business;
- 43.11 the Customer's financial position deteriorates to such an extent that in EOF's opinion the Customer's capability to adequately fulfil its obligations under the Contract has been placed in jeopardy; and
- 43.12 (being an individual) the Customer dies or, by reason of illness or incapacity (whether mental or physical), is incapable of managing his or her own affairs or becomes a patient under any mental health legislation.
- 43.13 Termination of the Contract, however arising, shall not affect any of the parties' rights and remedies that have accrued as at termination. Clauses which expressly or by implication survive termination of the Contract shall continue in full force and effect.

LIMITATION OF LIABILITY

44. Nothing in these Conditions shall limit or exclude EOF's liability for:
- 44.1 death or personal injury caused by its negligence, or the negligence of its employees, agents or subcontractors (as applicable);
- 44.2 fraud or fraudulent misrepresentation;
- 44.3 breach of the terms implied by section 12 of the Sale of Goods Act 1979;

- 44.4 defective products under the Consumer Protection Act 1987; or
- 44.5 any matter in respect of which it would be unlawful for the EOF to exclude or restrict liability.
45. Subject to clause 44:
- 45.1 EOF shall under no circumstances whatever be liable to the Customer, whether in contract, tort (including negligence), breach of statutory duty, or otherwise, for any loss of profit, or any indirect or consequential loss arising under or in connection with the Contract; and
- 45.2 EOF's total liability to the Customer in respect of all other losses arising under or in connection with the Contract, whether in contract, tort (including negligence), breach of statutory duty, or otherwise, shall in no circumstances exceed the price of the Goods.

FORCE MAJEURE

46. EOF shall not be liable for any failure or delay in performing its obligations under the Contract to the extent that such failure or delay is caused by a Force Majeure Event. A Force Majeure Event means any event beyond a party's reasonable control, which by its nature could not have been foreseen, or, if it could have been foreseen, was unavoidable, including strikes, lock-outs or other industrial disputes (whether involving its own workforce or a third party's), failure of energy sources or transport network, acts of God, war, terrorism, riot, civil commotion, interference by civil or military authorities, national or international calamity, armed conflict, malicious damage, breakdown of plant or machinery, nuclear, chemical or biological contamination, sonic boom, explosions, collapse of building structures, fires, floods, storms, earthquakes, loss at sea, epidemics or similar events, natural disasters or extreme adverse weather conditions, or default of suppliers or subcontractors. If the event of force majeure continues for a continuous period in excess of 43 months, the Customer shall be entitled to give notice in writing to EOF to terminate the Contract.

GENERAL

47. EOF may at any time assign, transfer, charge, subcontract or deal in any other manner with all or any of its rights or obligations under the Contract.
48. The Customer may not assign, transfer, charge, subcontract or deal in any other manner with all or any of its rights or obligations under the Contract without EOF's prior written consent.
49. Any notice or other communication given to a party under or in connection with the Contract shall be in writing, addressed to that party at its registered office (if it is a company) or its principal place of business (in any other case) or such other address as that party may have specified to the other party in writing in accordance with this clause, and shall be delivered personally, sent by pre-paid first class post, recorded delivery, commercial courier, fax or e-mail.
50. A notice or other communication shall be deemed to have been received: if delivered personally, when left at the address referred to in clause 49; if sent by pre-paid first class post or recorded delivery, at 9.00 am on the second Business Day after posting; if delivered by commercial courier, on the date and at the time that the courier's delivery receipt is signed; or, if sent by fax or e-mail, one Business Day after transmission.
51. The provisions of clauses 49 and 50 shall not apply to the service of any proceedings or other documents in any legal action.
52. If any court or competent authority finds that any provision of the Contract (or part of any provision) is invalid, illegal or unenforceable, that provision or part-provision shall, to the extent required, be deemed to be deleted, and the validity and enforceability of the other provisions of the Contract shall not be affected.
53. If any invalid, unenforceable or illegal provision of the Contract would be valid, enforceable and legal if some part of it were deleted, the provision shall apply with the minimum modification necessary to make it legal, valid and enforceable.
54. A waiver of any right or remedy under the Contract is only effective if given in writing and shall not be deemed a waiver of any subsequent breach or default. No failure or delay by a party to exercise any right or remedy provided under the Contract or by law shall constitute a waiver of that or any other right or remedy, nor shall it preclude or restrict the further exercise of that or any other right or remedy. No single or partial exercise of such right or remedy shall preclude or restrict the further exercise of that or any other right or remedy.
55. A person who is not a party to the Contract shall not have any rights under or in connection with it.
56. Except as set out in these Conditions, any variation to the Contract, including the introduction of any additional terms and conditions, shall only be binding when agreed in writing and signed by EOF.
57. The Contract, and any dispute or claim arising out of or in connection with it or its subject matter or formation (including non-contractual disputes or claims), shall be governed by, and construed in accordance with, English law, and the parties irrevocably submit to the exclusive jurisdiction of the courts of England and Wales.

ELITE OFFICE FURNITURE UK LIMITED

Goole Office, Showroom & Factory

Elite Road
Goole
East Yorkshire
DN14 8BF
United Kingdom

Tel. +44 (0)1405 746000

Email. sales@elite-furniture.co.uk
www.elite-furniture.co.uk

London Office & Showroom

81-87 St John Street
Clerkenwell
London
EC1M 4NQ
United Kingdom

Tel. +44 (0)20 7490 4909

Email. londonshowroom@elite-furniture.co.uk